

Supplementary Information for: Control and Regulation of Pathways via Negative Feedback

Herbert M. Sauro

Department of Bioengineering,
William H. Foege Building, University of Washington,
Box 355061, Seattle, USA, 98195-5061

December 28, 2016

Supplementary Information

This supplement contains additional text related to proofs and commentary on aspects touched upon in the main article.

1 Derivation of Equations (6) and (7)

The Hill equation [1] was originally used to describe the sigmoid response found in the binding of oxygen to hemoglobin. In the original publication by Hill, the equation was empirically derived and a mechanistic explanation was not provided. It was only later that a mechanistic model was proposed that attempted to justify the Hill equation. The proposed mechanistic model is perhaps overly simplistic and even unrealistic, but it provides a useful baseline when considering other models.

Consider an oligomer with n subunits and a binding site on each subunit for a ligand, S . If we make the assumption that when the first ligand binds, the binding affinity for the remaining $n - 1$ sites change such that all the remaining ligands also bind simultaneously, then we can represent this situation as follows:



Assuming the rapid equilibrium assumption we can write:

$$K_a = \frac{ES_n}{E \cdot S^n}$$

where K_a is the association constant for ligand binding. Using the conservation relation $E_t = E + ES_n$, the fractional saturation can be shown to be given by:

$$\frac{ES}{E_t} = \frac{S^n}{1/K_a + S^n} = \frac{S^n}{K_d + S^n} = Y \quad (2)$$

This is the **Hill equation** (3) where K_d is the dissociation constant. Often the Hill equation is represented in the literature as:

$$v = \frac{V_m S^n}{K_d + S^n} \quad (3)$$

where K_d is the dissociation constant, n the **Hill coefficient** and V_m the maximal velocity. Traditionally the Hill coefficient is represented using the symbol, h . The only reason why n is used here is because it specifically refers to the number of binding sites in the proposed model (1). In general, experimental determination of Hill coefficients often reveals fractional values indicating that the simple Hill model fails to adequately explain cooperativity, although empirically the fit can be quite good. For example, although hemoglobin has four binding sites, the measured Hill coefficient is 2.7. Similarly for PFK where the number of binding sites for F6P is four, the Hill coefficient is about 3.7. Most literature therefore refers to the Hill coefficient using the symbol h indicating that this is the measured coefficient.

Sometimes the Hill equation is also expressed in terms of the half-maximal activity constant, K_H , that is the concentration of ligand that gives half maximal activity. To

do this we set the left-hand side (3) to 0.5 and find the relationship between S and K_d , such that:

$$S = \sqrt[n]{K_d}$$

$\sqrt[n]{K_d}$ is the half-maximal activity value, or $K_H = \sqrt[n]{K_d}$, that is $K_H^n = K_d$. We can therefore write the Hill equation in a number of alternative but equivalent forms:

$$v = \frac{V_m S^n}{K_H^n + S^n} = \frac{V_m \left(\frac{S}{K_H}\right)^n}{1 + \left(\frac{S}{K_H}\right)^n} \equiv \frac{V_m S^n}{K_d + S^n} \quad (4)$$

The equation in terms of the half-maximal activity has advantages because half-maximal activity can sometimes be measured directly from experiments, especially transcription factors binding to operator sites on DNA.

If ligand binding acted in the way suggested in the derivation of the Hill equation, n would represent the number of binding sites, an integer. However, fitting the Hill equation to real data rarely gives integer estimates to n suggesting the model is not a good representation of the real system. The utility of the Hill equation however lies in its ability to describe sigmoid behavior for simple cooperative systems such as transcription factor binding. As a result, it has been adopted by the modeling community. However it is severely limited in some aspects. It is not possible to easily add regulator terms to the equation (although this is often done in an ad hoc manner) or model multi-reactant systems and more problematic is that it models an irreversible reaction.

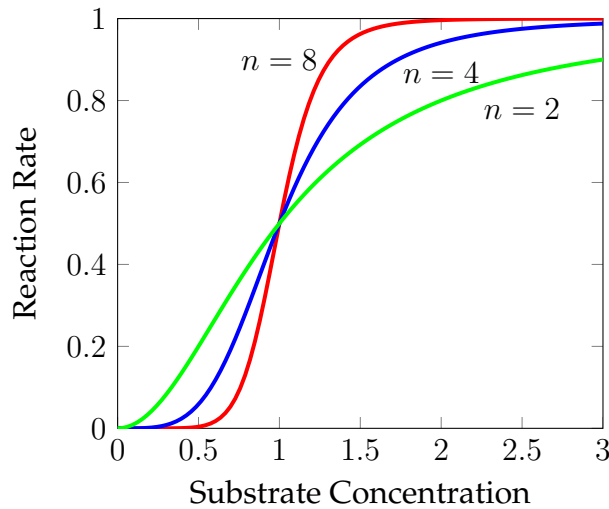

Figure 1: Plot showing the response of the rate set to the indicated values and $K_H = 1$.

The limitations of the traditional Hill equation have been resolved by Hofmeyr and Cornish-Bowden [2] who derived a new, more adaptable reversible Hill equation.

Elasticity of Hill Equation

The elasticity coefficient, ε_S^v may be derived directly from the Hill equation (3). Differentiating and scaling the Hill equation yields the following elasticity both in terms of the dissociation constant, K_d and the half maximal activity constant, K_H :

$$\varepsilon_S^v = \frac{n K_d}{K_d + S^n} = \frac{n}{1 + \left(\frac{S}{K_H}\right)^n} \quad (5)$$

For comparison with the K_d for of the equation we note that:

$$\varepsilon_S^v = \frac{n}{1 + \left(\frac{S^n}{K_d}\right)} = \frac{n}{1 + \left(\frac{S}{K_H}\right)^n}$$

The elasticity of a reaction obeying the Hill equation has a value equal to n at low substrate concentrations ($S \ll K_d$). In contrast, irreversible Michaelian enzymes at low substrate concentrations have an elasticity value of one. Therefore an enzyme obeying the Hill equation shows a much higher elasticity to the substrate concentration compared to a Michaelian enzyme. Like a Michaelian enzyme, the value of the elasticity falls off rapidly as the substrate concentration increases, reaching zero as the enzyme becomes saturated. Figure 2 illustrates this response for $n = 4$ and $K_d = 1$. An interesting feature in Figure 2 is the delayed fall in the elasticity at low substrate concentrations. This is in contrast to a Michaelian response which falls immediately from the initial point, $S = 0$. The characteristics of the curve at $S = 0$ can change quite markedly in different models of cooperativity.

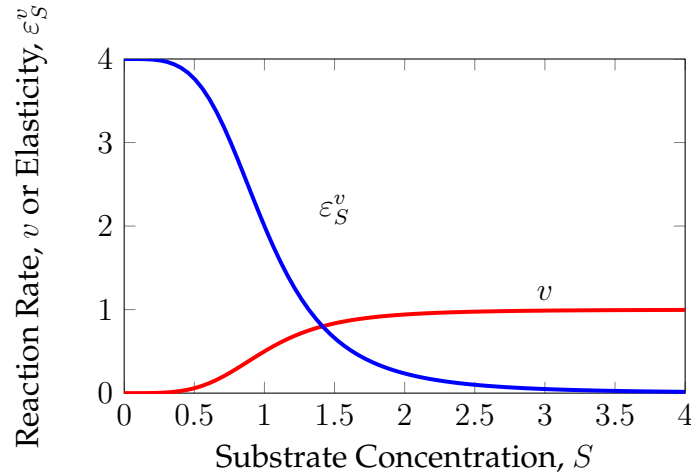

Figure 2: Plot showing the response of the rate and elasticity for the Hill model, with $n = 4$ and $K_d = 1$.

Equation (2) represents the fractional saturation for the Hill model. If we subtract both sides of this equation from one, we get:

$$1 - Y = 1 - \frac{S^n}{K_d + S^n}$$

$$1 - Y = \frac{K_d}{K_d + S^n}$$

$$\frac{1}{1 - Y} = \frac{K_d + S^n}{K_d}$$

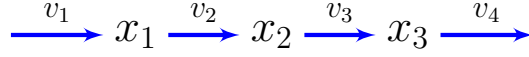

Figure 3: Simple Four Step Unbranched Pathway.

Multiplying both sides by the elasticity expression leads to the cancelation of the term, $(K_d + S^n)/K_d$. Therefore the elasticity¹ is related to the Hill coefficient by the simple relation:

$$\varepsilon_S^v \frac{1}{1 - Y} = n$$

This means that at low saturation levels, the elasticity coefficient approximately equals the Hill coefficient. Another way of expressing this relation:

$$\varepsilon_S^v = n(1 - Y) \quad (6)$$

The elasticity is proportional to the degree to which the enzyme is *not* saturated. If a cooperative enzyme is at half-saturation then $\varepsilon_S^v = \frac{1}{2}n$

2 Proof for Ratio of Coefficients

Consider a unbranched pathway of four product inhibited reactions shown in Figure 3. The connectivity theorem [3] allows us to write the following connectivity relationships centered around each metabolite, x_1 , x_2 and x_3 :

$$\frac{C_1^J}{C_2^J} = -\frac{\varepsilon_1^2}{\varepsilon_1^1}, \quad \frac{C_2^J}{C_3^J} = -\frac{\varepsilon_2^3}{\varepsilon_2^2}, \quad \frac{C_3^J}{C_4^J} = -\frac{\varepsilon_3^4}{\varepsilon_3^3}$$

where C_i^J is the flux control coefficient of the i^{th} reaction step and ε_j^i the elasticity coefficient of the reaction rate at reaction i with respect to metabolite j . The first expression can be rewritten as:

$$\frac{C_1^J}{C_2^J} = -\frac{1}{\varepsilon_1^2/\varepsilon_1^1}$$

That is:

$$C_1^J : C_2^J = 1 : -\frac{\varepsilon_1^1}{\varepsilon_1^2} \quad (7)$$

Likewise the second and third connectivity expressions can be written as:

$$C_2^J : C_3^J = 1 : -\frac{\varepsilon_2^2}{\varepsilon_2^3} \quad C_3^J : C_4^J = 1 : -\frac{\varepsilon_3^3}{\varepsilon_3^4} \quad (8)$$

We can combine equations (7), and (8) to yield:

$$C_1^J : C_2^J : C_3^J : C_4^J = 1 : -\frac{\varepsilon_1^1}{\varepsilon_1^2} : -\frac{\varepsilon_1^1}{\varepsilon_2^2} \left(-\frac{\varepsilon_2^2}{\varepsilon_2^3} \right) : -\frac{\varepsilon_1^1}{\varepsilon_3^3} \left(-\frac{\varepsilon_2^2}{\varepsilon_2^3} \right) \left(-\frac{\varepsilon_3^3}{\varepsilon_3^4} \right) \quad (9)$$

¹The same result may also be obtained by expanding the slope of the Hill plot, $n = d \log(Y)/(1 - Y) / d \log S$ and extracting the elasticity.

The proof generalizes to any length unbranched pathway such that the n^{th} term, where $n > 1$, corresponding to C_n^J will equal:

$$\prod_{i=1}^{n-1} \left(-\frac{\varepsilon_i^i}{\varepsilon_i^{i+1}} \right)$$

The first term at $n = 1$ is set equal to one.

3 Proof for Equations (18) and Table (2)

Equation (18) and those in Table 2 gives the control equations for an unbranched pathway of four species with a negative feedback loop from the last metabolite, X_3 to the first step. The equations in the main text are shown here for convenience:

$$D = \varepsilon_1^1 \varepsilon_2^2 \varepsilon_3^4 - \varepsilon_1^1 \varepsilon_2^2 \varepsilon_3^3 - \varepsilon_1^1 \varepsilon_2^3 \varepsilon_3^4 + \varepsilon_1^2 \varepsilon_2^3 \varepsilon_3^4 - \varepsilon_1^2 \varepsilon_2^3 \underline{\varepsilon_{fd}} \quad (10)$$

where $\underline{\varepsilon_{fd}}$ is the feedback elasticity and the four control coefficients shown in Table 1.

Control Coefficient	Numerator
$C_{e_1}^{x_3}$	$\varepsilon_1^2 \varepsilon_2^3$
$C_{e_4}^{x_3}$	$\varepsilon_1^1 \varepsilon_2^2 - \varepsilon_1^1 \varepsilon_2^3 + \varepsilon_1^2 \varepsilon_2^3$
$C_{e_1}^J$	$\varepsilon_1^2 \varepsilon_2^3 \varepsilon_3^4$
$C_{e_4}^J$	$-\varepsilon_1^1 \varepsilon_2^2 \varepsilon_3^3 - \varepsilon_1^2 \varepsilon_2^3 \underline{\varepsilon_{fd}}$

Table 1: Control Coefficients and Corresponding Numerators of Control Equations. The feedback elasticity is highlighted in underline/red, $\underline{\varepsilon_{fd}}$

There are different ways to derive the control coefficient equations. Here we use the method proposed by Fell and Sauro [4]. The method works well for small pathways with limited structure but can become cumbersome for larger and more complex pathways because of the requirement to supply additional theorems. For larger systems symbolic computational methods are recommended [5].

The Fell and Sauro method relies on stacking the theorems into a matrix and inverting the matrix. In this case we have four reaction steps, therefore there will be one summation theorem and three connectivity theorems. A Mathematica script was used to do the matrix inversion and is shown below:

```
(* Define the elasticity matrix using the summation
and three connectivity theorems. fd is the negative
feedback elasticity. eij notation is used to represent
elasticities where i is the reaction and j the species. *)
eeMatrix = {{1, 1, 1, 1},
            {e11, e21, 0, 0},
            {0, e22, e32, 0},
            {fd, 0, e33, e43}}
```

```

(* Invert the matrix and return the first column which
   contains the flux control coefficients *)
firstColumn := Inverse[eeMatrix][[All, 1]]

(* Get the common denominator *)
den := Denominator[firstColumn[[1]]]

-e11 e22 e33 + e11 e22 e43 - e11 e32 e43 + e21 e32 e43 - e21 e32 fd

(* List the four numerators for the flux control coefficients *)
Numerator[firstColumn]

{ e21 e32 e43,
  -e11 e32 e43,
  e11 e22 e43,
  -e11 e22 e33
  -e21 e32 fd}

(* Get the concentration control coefficients for x3 in the 4th column.
   Take the negative to account for the negative term on the right-side of
   the concentration connectivity theorem. See Fell & Sauro for details *)
fourthColumn := -Inverse[ee4][[All, 4]]

(* list the for numerators for the
   concentration (x4) control coefficients *)

{e21 e32,
 -e11 e32,
  e11 e22,
 -e11 e22 + e11 e32 - e21 e32}

```

4 Evaluating Equations (11) in the Main Text

Equations (11) in the main text describes how the flux control in an unbranched pathways depends on metabolite and equilibrium constants. These equations were derived using the following Mathematica script that involves four reaction steps. Inspection of the resulting equations were generalized to any sized unbranched pathway.

```

Solve[{C1/C2 - (1 - p1)/(p1 (1 - p2)) == 0 ,
       C2/C3 - p1 (1 - p2)/(p1 p2 (1 - p3)) == 0,
       C3/C4 - p1 p2 (1 - p3)/(p1 p2 p3 (1 - p4)) == 0,
       C1 + C2 + C3 + C4 == 1}, {C1, C2, C3, C4}]

```

Output:

```

{{C1 -> -((1 - p1)/(-1 + p1 p2 p3 p4)),
  C2 -> (p1 (-1 + p2))/(-1 + p1 p2 p3 p4),
  C3 -> (p1 (-p2 + p2 p3))/(-1 + p1 p2 p3 p4),
  C4 -> -((p1 p2 p3 - p1 p2 p3 p4)/(-1 + p1 p2 p3 p4))}}

```

5 Simple Quantitative Analysis of Negative Feedback

Here we will consider some basic properties of negative feedback systems. Later chapters will consider negative feedback in much more detail. The simplest way to think about feedback quantitatively is by reference to Figure 4.

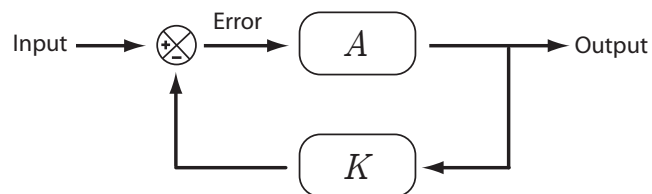

Figure 4: Generic structure of a negative feedback system.

We will assume some very simple rules that govern the flow of information in this feedback system. For example, the output signal, y_o , will be the value of A multiplied by the error, e . The feedback signal will be assumed to be proportional to y_o , that is Ky_o . Finally, the error signal, e will be given by the difference between the set point, y_i and the feedback signal, Ky_o (Figure 5).

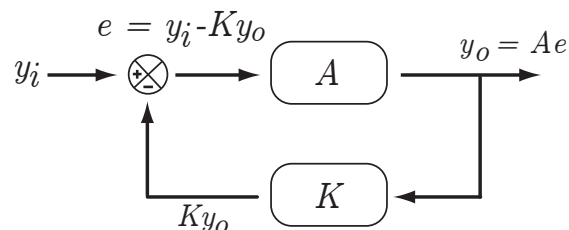

Figure 5: Annotated negative feedback system.

Noting that $e = y_o/A$ and substituting this into $e = y_i - Ky_o$ and solving for y_o we obtain:

$$y_o = \frac{Ay_i}{1 + AK} \quad \text{or more simply} \quad y_o = Gy_i \quad (11)$$

where:

$$G = \frac{A}{1 + AK} \quad (12)$$

G is called the gain of the feedback loop, often called the **closed loop gain**. *Gain* is a term that is commonly used in control theory and refers to the scalar change between an input and output. Thus a gain of 2 simply means that a given output will be twice the input.

The **gain** is a measure of the change that occurs between a signal output and its input. A gain of two means that the output will change two times in magnitude compared to a change in the input.

In addition to the close loop gain, engineers also define two other gain factors, the **open loop gain** and the important **loop gain**. The open loop gain is simply the gain generated by the process, A . It would be the gain between y_o and y_i if the feedback loop were absent. The loop gain is the gain from the feedback and process A combined, AK . The loop gain is an important quantity when discussing the stability and general performance of feedback circuits. Figure 5 illustrates the different types of gain in a feedback circuit, also summarized in Table 2.

Gain	Expression
Open Loop Gain	A
Loop Gain	AK
Closed Loop Gain	$\frac{A}{1 + AK}$

Table 2: Definition of Various Loop Gains

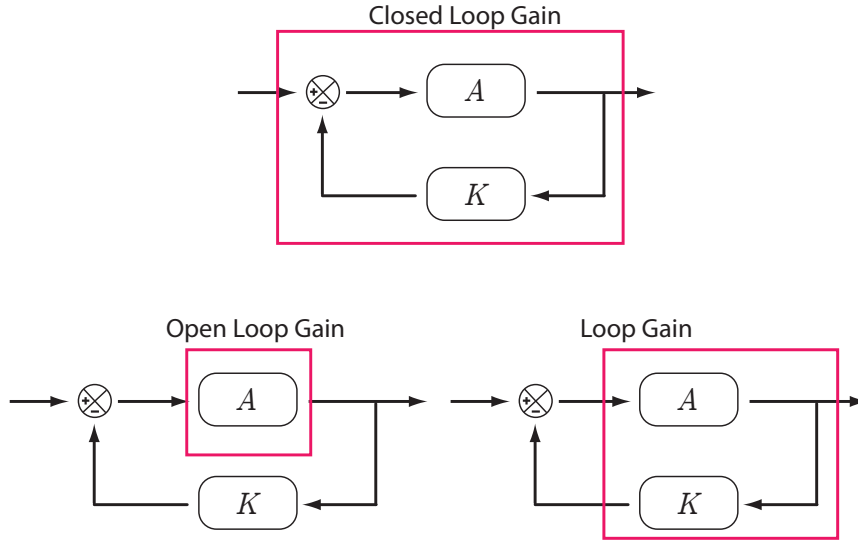

Figure 6: The various loop gains in a negative feedback system.

We can use equation (11) to discover some of the basic properties of a negative feedback circuit. The first thing to note is that as the loop gain, AK , increases, the system behavior becomes more dependent on the feedback loop and less dependent on the rest of the system:

$$\text{when } AK \gg 1 \text{ then } G \simeq \frac{A}{AK} = \frac{1}{K}$$

This apparently innocent effect has significant repercussions on other aspects of the circuit. To begin with, the system becomes less dependent on A . That is feedback makes the performance of the system independent of any variation in A . Such variation might include noise, temperature or variation as a result of the manufacturing process or in the case of biological systems, genetic variation. To be more precise we can compute the sensitivity of the gain G with respect to variation in A .

$$\frac{\partial G}{\partial A} = \frac{\partial}{\partial A} \frac{A}{1 + AK} = \frac{1}{(1 + AK)^2}$$

If we consider the relative sensitivity we find:

$$\frac{\partial G}{\partial A} \frac{A}{G} = \frac{1}{1 + AK}$$

From this we can see that as the loop gain increases the sensitivity decreases.

Functional Modules In addition to resistance to parameter variation, feedback also confers resistance to disturbances in the output. Suppose that a nonzero disturbance d affects the output. The system behavior is then described by

$$y = Ae - d \quad e = y_i - Ky.$$

Eliminating e , we find

$$y = \frac{Ay_i - d}{1 + AK}.$$

The sensitivity of the output to the disturbance is then

$$\frac{\partial y}{\partial d} = -\frac{1}{1 + AK}.$$

The sensitivity decreases as the loop gain AK is increased. In practical terms, this means that the imposition of a load on the output, for example a current drain in an electronic circuit, protein sequestration on a signaling network or increased demand for an amino acid will have less of an effect on the circuit as the feedback strength increases. In electronics this property essentially separates the network into **functional modules**.

Fidelity For a servo mechanism such as an amplifier where the output tracks the input, feedback confers a critical benefit, that is improved fidelity of the response. This means for a given change in the input, a system with feedback is more likely to faithfully reproduce the input at the output than a circuit without feedback. An ability to faithfully reproduce signals is critical in electronics communications and in fact it was this need that was one of the inspirations for the development of negative feedback in the early electronics industry. The next section on linearization will cover this in more detail.

Linearization Properties Related to the improvement in fidelity is linearization due to feedback. Consider the case where the amplifier A is nonlinear. For example a protein cascade pathway exhibiting a sigmoid response. Then the behavior of the system G (now also nonlinear) is described by

$$G(y_i) = y_o = A(e) \quad e = y_i - Ky_o = y_i - KG(y_i).$$

Differentiating we find

$$G'(y_i) = A'(y_i) \frac{de}{dy_i} \quad \frac{de}{dy_i} = 1 - KG'(y_i).$$

Eliminating $\frac{de}{dy_i}$, we find

$$G'(y_i) = \frac{A'(y_i)}{1 + A'(y_i)K}.$$

We find then, that if $A'(y_i)K$ is large ($A'(y_i)K \gg 1$), then

$$G'(y_i) \approx \frac{1}{K},$$

That is $G(y_i) = y_i/K$. This means that G is approximately linear (Recall that K is constant).² In this case, the feedback compensates for the nonlinearities $A(\cdot)$ and the system response is not distorted. Another feature of this analysis is that the slope of $G(\cdot)$ is less than that of $A(\cdot)$, i.e. the response is “stretched out”. For instance, if $A(\cdot)$ is saturated by inputs above and below a certain “active range”, then $G(\cdot)$ will exhibit the same saturation, but with a broader active range.

One objection to the implementation of feedback as described is that the system sensitivity is not actually reduced, but rather is shifted so that the response is more sensitive to the feedback K and less sensitive to the amplifier A . However, in each of the cases described above, we see that it is the nature of the loop gain AK (and not just the feedback K) which determines the

²I'd like to thank Brian Ingalls for his contribution here.

extent to which the feedback affects the nature of the system. This suggests an obvious strategy. By designing a system which has a small “clean” feedback gain and a large “sloppy” amplifier, one ensures that the loop gain is large and the behavior of the system is satisfactory. Engineers employ precisely this strategy in the design of electrical feedback amplifiers, regularly making use of amplifiers with gains several orders of magnitude larger than the feedback gain (and the gain of the resulting system). Because the amplifier A need not be precise, it means that the costs for manufacturing the amplifier can be greatly reduced. Instead the cost can be shifted to the feedback which is generally a much simpler mechanism. This is clearly seen in the use of op amps as amplifiers. The op amp is a complex circuit that exhibits a huge gain factor. However op amps are very cheap because negative feedback can be used to reduce the effect of manufacturing variation in the op amp. Instead, the cost is shifted to using high precision but cheap resistors to implement the negative feedback circuit.

Useful Properties Resulting from Negative Feedback

1. Amplification of signal.
2. Robustness to internal component variation.
3. High fidelity of signal transfer.
4. Low output impedance so that the load does not affect the performance of the circuit.

Negative feedback can also yields additional benefits that include fast response times and a better response to fast changing signals. A detailed analysis is beyond the scope of this article but relies on the study of the system in the frequency domain [6, 7, 8, 9].

6 Deriving Control Equations

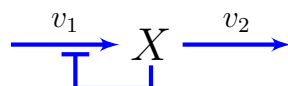

Figure 7: Simplest pathway with negative feedback. Species X inhibits the reaction rate v_1

Deriving Equation (17) for Pathway in Figure 7

Equation (17) is reproduced below and describes how changes in E_2 influence the steady state concentration of X .

$$C_{e_2}^x = -\frac{1}{\varepsilon_x^2 - \varepsilon_x^1} \quad (13)$$

To derive the equation we start by perturbing E_2 by an amount δe_2 . This results in changes to X by an amount δx and changes to the reaction rates, v_1 and v_2 by amounts δv_1 and δv_2 respectively. These changes can be described using the relations:

$$\delta v_2 \approx \frac{\partial v_2}{\partial e_2} \delta e_2 + \frac{\partial v_2}{\partial x} \delta x$$

$$\delta v_1 \approx \frac{\partial v_1}{\partial x} \delta x$$

We allow the system to come to a new steady state so that the change in the two reaction rates will be equal: $\delta v_1 = \delta v_2$. This allows us to set the two perturbation equations equal to each other, that is:

$$\frac{\partial v_1}{\partial x} \delta x \approx \frac{\partial v_2}{\partial e_2} \delta e_2 + \frac{\partial v_2}{\partial x} \delta x$$

Solving for the ratio $\delta x / \delta e_2$ yields:

$$\frac{\delta x}{\delta e_2} \approx -\frac{\frac{\partial v_2}{\partial e_2}}{\frac{\partial v_2}{\partial x} - \frac{\partial v_1}{\partial x}}$$

Taking the limit $\delta e_2 \rightarrow 0$, and scaling both sides by multiplying by e_2 and dividing by x yields the equation for the concentration control coefficient for E_2 :

$$C_{e_2}^x = -\frac{1}{\varepsilon_x^2 - \varepsilon_x^1}$$

Flux Control Equations

Given a perturbation in E_1 of δe_1 , the change in the steady state flux, δJ at v_2 through the pathway can be written

$$\delta J \approx \frac{\partial v_2}{\partial x} \delta x$$

Dividing both sides by δe_1 gives us:

$$\frac{\delta J}{\delta e_1} \approx \frac{\partial v_2}{\partial x} \frac{\delta x}{\delta e_1}$$

In the limit as $\delta e_1 \rightarrow 0$ and scaling both sides gives:

$$C_{e_1}^J = \varepsilon_x^2 C_{e_1}^x$$

However we know that $C_{e_1}^x = 1/(\varepsilon_x^2 - \varepsilon_x^1)$ so that:

$$C_{e_1}^J = \frac{\varepsilon_x^2}{\varepsilon_x^2 - \varepsilon_x^1}$$

The same approach can be used to derive the equation for $C_{e_2}^J$, but this time perturbing E_2 . This leads to the following result:

$$C_{e_2}^J = \frac{-\varepsilon_x^1}{\varepsilon_x^2 - \varepsilon_x^1}$$

Note that the sum:

$$C_{e_1}^J + C_{e_2}^J = \frac{\varepsilon_x^2}{\varepsilon_x^2 - \varepsilon_x^1} + \frac{-\varepsilon_x^1}{\varepsilon_x^2 - \varepsilon_x^1} = 1$$

7 General Expression for a Unbranched Pathway

Given an unbranched pathway of n steps, the flux control coefficient for the i^{th} step is given by the expression [10]:

$$C_i^J = \frac{(-1)^{i+1} \prod_{k=i-1}^{k=i-1} \varepsilon_k^k \prod_{k=i+1}^n \varepsilon_{k-1}^k}{1 \cdot D}$$

where D is given by:

$$D = \sum_{i=1}^n \left((-1)^{i+1} \prod_{k=i+1}^{k=i-1} \epsilon_k^k \prod_{k=i+1}^n \epsilon_{k-1}^k \right)$$

There are various ways to derive this expression. Probably the easiest is by deriving the expressions for two, three and four steps and using these results to generalize to n steps. The Mathematica script below will derive the flux control expressions for two, three and four step pathways.

```
ee2={{1,1},{e11,e21}}
fluxControl:=Inverse[ee2][[All,1]]
concentrationControl1:=-Inverse[ee2][[All,2]]

ee3={{1,1,1},{e11,e21,0},{0,e22,e32}}
fluxControl:=Inverse[ee3][[All,1]]
concentrationControl1:=-Inverse[ee3][[All,2]]
concentrationControl2:=-Inverse[ee3][[All,3]]

ee4={{1,1,1,1},{e11,e21,0,0},{0,e22,e32,0},{0,0,e33,e43}}
fluxControl:=Inverse[ee4][[All,1]]
concentrationControl1:=-Inverse[ee4][[All,2]]
concentrationControl2:=-Inverse[ee4][[All,3]]
concentrationControl3:=-Inverse[ee4][[All,4]]
```

The following equations are the four flux control coefficients to a four step unbranched pathway:

$$C_1^J = -\frac{\epsilon_1^2 \epsilon_2^3 \epsilon_3^4}{\epsilon_1^2 \epsilon_2^3 \epsilon_3^4 - \epsilon_1^1 \epsilon_2^3 \epsilon_3^4 + \epsilon_1^1 \epsilon_2^2 \epsilon_3^4 - \epsilon_1^1 \epsilon_2^2 \epsilon_3^3}$$

$$C_2^J = \frac{\epsilon_1^1 \epsilon_2^3 \epsilon_3^4}{\epsilon_1^2 \epsilon_2^3 \epsilon_3^4 - \epsilon_1^1 \epsilon_2^3 \epsilon_3^4 + \epsilon_1^1 \epsilon_2^2 \epsilon_3^4 - \epsilon_1^1 \epsilon_2^2 \epsilon_3^3}$$

$$C_3^J = -\frac{\epsilon_1^1 \epsilon_2^2 \epsilon_3^4}{\epsilon_1^2 \epsilon_2^3 \epsilon_3^4 - \epsilon_1^1 \epsilon_2^3 \epsilon_3^4 + \epsilon_1^1 \epsilon_2^2 \epsilon_3^4 - \epsilon_1^1 \epsilon_2^2 \epsilon_3^3}$$

$$C_4^J = \frac{\epsilon_1^1 \epsilon_2^2 \epsilon_3^3}{\epsilon_1^2 \epsilon_2^3 \epsilon_3^4 - \epsilon_1^1 \epsilon_2^3 \epsilon_3^4 + \epsilon_1^1 \epsilon_2^2 \epsilon_3^4 - \epsilon_1^1 \epsilon_2^2 \epsilon_3^3}$$

An alternative way to derive the general equation is to use the summation and connectivity theorems and solve for the flux control coefficients. This approach can be found in the book by Heinrich and Schuster [11] on page 165.

References

- [1] Hill AV. The possible effects of the aggregation of the molecules of haemoglobin on its dissociation curves. *J Physiol.* 1910;40(4).
- [2] Hofmeyr JH, Cornish-Bowden A. The reversible Hill equation: how to incorporate cooperative enzymes into metabolic models. *Comput Appl Biosci.* 1997 Aug;13(4):377–385.

- [3] Kacser H, Burns J, Fell D. The control of flux. *Biochemical Society Transactions*. 1995;23(2):341–366.
- [4] Fell DA, Sauro HM. Metabolic Control Analysis: Additional relationships between elasticities and control coefficients. *Eur J Biochem*. 1985;148:555–561.
- [5] Rohwer JM, Akhurst TJ, Hofmeyr JHS. Symbolic control analysis of cellular systems. In: *Experimental Standard Conditions of Enzyme Characterizations. Proceedings of the 3rd International Beilstein Workshop*. Beilstein-Institut zur Förderung der Chemischen Wissenschaften; 2008. p. 137–148.
- [6] Sauro HM. *Control Theory for Bioengineers*. Ambrosius Publishing; 2017.
- [7] Del Vecchio D, Dy AJ, Qian Y. Control theory meets synthetic biology. *Journal of The Royal Society Interface*. 2016;13(120):20160380.
- [8] Khammash M. An engineering viewpoint on biological robustness. *BMC biology*. 2016;14(1):1.
- [9] Ogata K. *Modern control engineering* 5th edition. Lugar: Upper Saddle River, New Jersey 07458. Prentice Hall; 2009.
- [10] Sauro HM. *Control Analysis and Simulation of Metabolism*; 1986.
- [11] Heinrich R, Schuster S. *The Regulation of Cellular Systems*. Chapman and Hall; 1996.