

## Modelling the Axial Response of the Roll-N-Cage Device for Seismic Isolation

M. Colombo<sup>1</sup>, M. Domaneschi<sup>2</sup>, M. Ismail<sup>3</sup>, L. Martinelli<sup>4</sup>, J. Rodellar<sup>5</sup>

<sup>1,2,4</sup>*Department of Civil and Environmental Engineering, Politecnico di Milano, Milan, Italy*

<sup>3</sup>*Structural Engineering Department, Zagazig University, Zagazig, Egypt*

<sup>5</sup>*Departament de Matemàtiques, Universitat Politècnica de Catalunya, Barcelona, Spain*

### ABSTRACT

The present study focuses on the axial characterization of the Roll-N-Cage isolation device. The procedure consists into two main steps: (i) laboratory investigations of a scaled prototype of the Roll-N-Cage system for evaluating the mechanical cyclic response to axial compression and tension; (ii) the development of a numerical model for investigating the reproduction of the strong unsymmetrical axial response of the device. The proposed numerical model reposes on a modified form of the Wang and Wen model by supplementing it with user identified scaling functions.

**Keywords:** *RNC device, seismic isolation, axial response, laboratory, numerical simulations*

### 1 INTRODUCTION

The Roll-N-Cage device (RNC in the following) is a new aseismic isolation device that has been proposed in the last decade [1]. One of the device peculiarities is that it includes several interesting features and mechanisms (isolation, energy dissipation, buffering) in a single unit. Indeed, the device is able to provide stiffness against low loading levels (e.g., wind and traffic) while, at the same time, retaining horizontal flexibility and providing vertical stiffness and strength for supporting heavy dead loads. Other interesting features can be alternatively implemented: such as recentering capability or no uplift during its lateral motion. As a completion of a previous studies [2,3] on the simulation of the Roll-N-Cage device by uncoupled orthogonal unidirectional models and coupled bidirectional models, this work first characterizes the axial response of the device by an experimental campaign and numerical modelling.

The need of an axial formulation stems from analytical studies, which have highlighted a strong asymmetric response of the RNC, affecting the seismic response in the nonlinear range. Furthermore, laboratory data confirmed such complex behaviour, in particular when the axial response is coupled with large horizontal displacements.

The first step of the study consists in the laboratory characterization of the axial signature of a scaled RNC prototype. The tests were performed by cyclic axial input able to highlight the asymmetric intrinsic behaviour of the device under compression loading (for which very small displacements and an high compression stiffness was found) and tensile axial forces (for which some components can undergo to an elastic-plastic post critical behaviour).

---

<sup>1</sup> PhD student, [martina.colombo@polimi.it](mailto:martina.colombo@polimi.it)

<sup>2</sup> Contract Professor, [marco.domaneschi@polimi.it](mailto:marco.domaneschi@polimi.it)

<sup>3</sup> Associate Professor, [mohammed.ismail@upc.edu](mailto:mohammed.ismail@upc.edu)

<sup>4\*</sup> Associate Professor, [luca.martinelli@polimi.it](mailto:luca.martinelli@polimi.it)

<sup>5</sup> Professor, [jose.rodellar@upc.es](mailto:jose.rodellar@upc.es)

The second step of the analyses consists in the development of a numerical model of the axial behaviour of the device. Previous studies from literature are the starting point of the proposed formulation [4,5]. The final goal of this research study is to reproduce cyclic laboratory tests in Matlab environment [6] by an innovative approach.

## 2 THE RNC DEVICE

The Roll-N-Cage isolator has been proposed as an enhancement of aseismic design. It is a rolling-based isolation system to achieve the maximum possible structure-ground decoupling and, therefore, to minimize the seismic force transfer to the isolated structure. It provides in a single unit all the necessary functions of vertical rigid support, horizontal flexibility with enhanced stability, hysteretic energy dissipation and resistance to minor vibration loads. Three unique features distinguish the RNC isolator: 1) a self-stopping (buffer) mechanism to limit the isolator displacement under severe seismic excitations to a predetermined value; 2) a linear gravity-based self-recentering mechanism can prevent residual dislocations after earthquakes; and 3) a remarkable ability to resist vertical tension by means of its metallic yield dampers.

The RNC isolator can be available in different arrangements to suit the structure or object to be protected regarding mass, size, uni or multidirectional isolation and the maximum allowed seismic gaps between adjacent structures, as shown in Fig. 1. Figs. 1a-b report the unidirectional and multi directional (respectively) light-moderate mass RNC model. When heavy masses have to be supported an additional steel reinforced rubber cylinder is introduced around the rolling core (Fig. 1c).

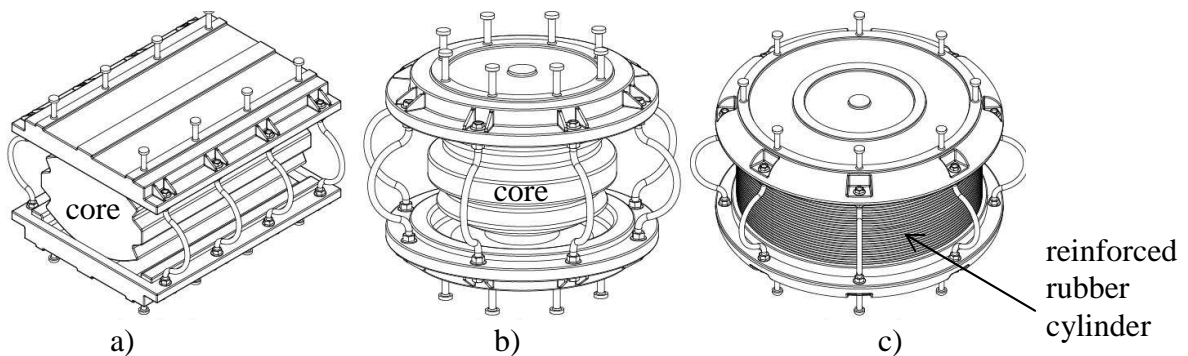

*Figure 1 – Unidirectional (a) and multi directional (b) light-moderate mass RNC model. Multidirectional heavy mass RNC system (c).*

For trying to improve and overcome the limits of existing isolation devices, the RNC isolator conveniently provides also a built-in buffer mechanism to limit the peak isolator displacement under seismic excitations stronger than the design earthquakes. It is related to the two right-angle grooves, cutting out from the quasi-ellipsoidal rolling body, together with the vertical edge-walls of the upper and lower bearing plates, see Fig. 2.: reaching the maximum deformed position, a locking mechanism is activated in which the rolling body core of the RNC isolator restrains as an inclined rigid link the steel plates at the top and at the bottom, allowing no further horizontal displacement.

Two main objectives are related to the integration of the buffer mechanism into the RNC isolator. The first one consists in limiting the horizontal displacement under extreme (low-probability) seismic events, with respect to a previously selected design displacement. The second one is to prevent pounding of the isolated structure itself with the surrounding adjacent structures. This is more evident when insufficient or limited seismic gaps between adjacent structures are present.

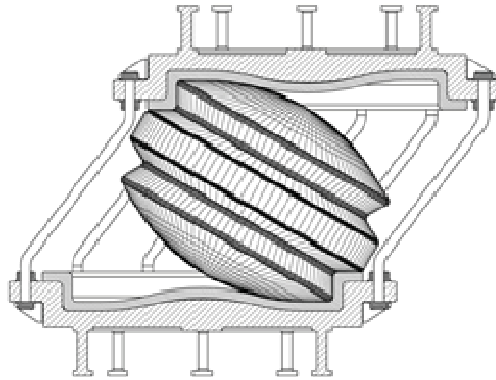

*Figure 2 – Buffer mechanism.*

### **3 LABORATORY TESTS**

The first step of the study consists in the laboratory characterization of the axial signature of a scaled RNC prototype. The tests were performed by cyclic axial input able to highlight the asymmetric intrinsic behaviour of the device. In particular, under compression loading condition the rolling body between the steel plates and the rubber pads allows small displacements before showing high compression stiffness. Conversely, under tensile axial forces, the surrounding metallic bars of the RNC show the classic elastic-plastic behaviour. However, under largest axial deformations the curved metallic bars tend to be straight; inverting at this point the axial force from tensile to compressive, the bars could be subjected to buckling.

#### **3.1 Testing machine**

A multi-purpose mechanical extension is designed for a Stewart Platform or “Hexapod” (by Quanser Consulting Inc., Markham, Ontario, Canada) as shown in Fig. 3, and later patented [7]. Such extension enables the Hexapod to perform up to fifteen standard mechanical tests, in addition its main function as a motion simulator. The testing platform is designed to get displacements and rotations as user inputs and transform them into forces and torques, respectively. Fig 3(b) illustrates one part of the designed mechanical extension. This part is suitable for testing experimental block-like, cylindrical and seismic isolation bearing specimens under tension, compression, shear, torsion and fatigue tests. More details about the designed Hexapod-based mechanical extension and extensive experimental testing of the RNC isolator are found in [8].

#### **3.2 Properties and working ranges of the testing machine**

A six degrees-of-freedom (DOF) force/torque sensor is used as a load-measuring unit. The accuracy of the used 6DOF sensor is 0.01 N with a maximum capacity up to 5000 N. After integrating the designed mechanical extension to the Hexapod together with the 6DOF sensor, the resulting Hexapod-based testing machine has the following working ranges and characteristics:

- Maximum acceleration: 1 g;
- Frequency range: 0 – 20 Hz;
- Dimensions: 1.1, 1.1 (horizontal) and 0.75 (vertical) m;
- Maximum speed ( $x$ ,  $y$  - horizontal - and  $z$  - vertical): 0.67, 0.67 and 0.35 m/s;
- Weight: 140 kg;

- Actuator maximum force: 334 N (six actuators);
- Actuator travel: +/- 30 mm;
- Maximum load: 5000 N;
- Rated power: 1500 W;
- Workspace (displacements in  $x$ ,  $y$  and  $z$ ): 0.30, 0.30 and 0.19 m;
- Workspace (rotations about  $x$ ,  $y$  and  $z$ ): 36.18, 36.18 and 50.19 deg;
- Maximum force ( $x$ ,  $y$  and  $z$ ): 1156.89, 1335.86 and 3797.62 N;
- Maximum torque (Roll, Pitch and Yaw): 548.14, 632.94 and 500.95 Nm;

### 3.3 Experimental prototypes of the RNC isolator

Different configurations of a 1/10 reduced-scale prototype of the RNC isolator have been designed based on the maximum allowed horizontal displacement to be provided. Such displacement is referred to Peak Displacement Limit (PDL), after which the inherent buffer mechanism of the RNC isolator is self-activated to impose a limit to the bearing's peak displacement regardless the excitation intensity. The prototypes' configurations are to provide five different values of PDD ranging from 40 mm to 60 mm with an increment of 5mm. Configurations are identical but the dimensions are slightly different to provide a different peak design displacement.

Fig. 4 shows two samples of the designed experimental prototypes; one is made of stiff-aluminum (with a design compressive capacity of 5 kN), while the other one is made of Delrin (with a design compressive capacity of 3 kN). The expression of stiff-aluminum is used in this paper to refer to the aluminum alloy 2024-T3 having density of 2.78 g/cm<sup>3</sup>; Young's Modulus of 73 GPa; ultimate tensile strength of 400-427 MPa; yield strength of 269-276 MPa. On the other hand, Delrin is a synthetic polymer known as Polyoxymethylene, which is an engineering thermoplastic used in construction of parts requiring high stiffness, low friction and excellent dimensional stability.

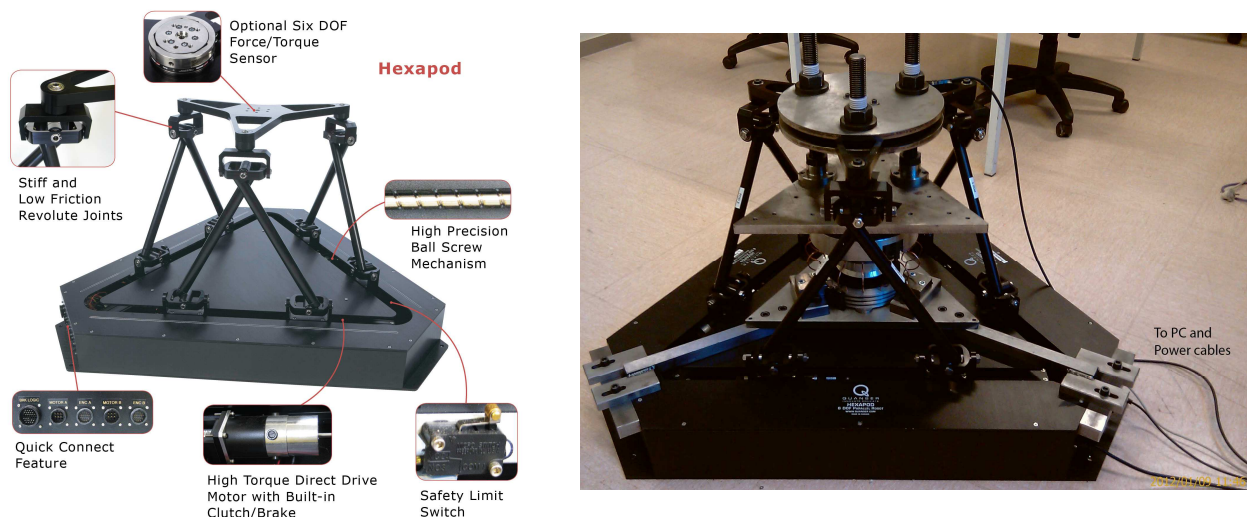

Figure 3 – Testing machine: (a) Hexapod (Quanser Consulting Inc., Markham, Ontario, Canada); (b) Hexapod-based testing platform.

### 3.4 Tension-compression testing methodology

The lower part of a RNC isolator prototype is tightly attached to the lower fixed base of the testing platform, while the upper part of the prototype is fastened to the upper moving base of the developed testing platform. Synthetic sinusoidal vertical displacements are applied to the upper moving base to generate a relative tension-compression motion within the RNC isolator prototypes (between its top moving part and the lower fixed one).

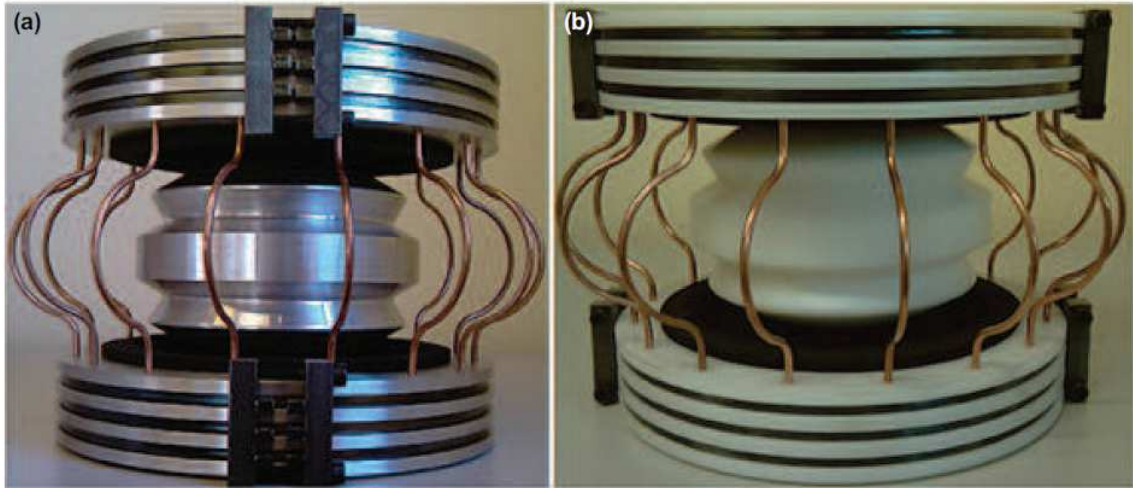

Figure 4: Small-scale prototypes of the RNC isolator: (a) stiff-aluminum; (b) Delrin.

This test is performed to study the behaviour of the metallic yield dampers under tensile loading, such that no separation occurs between the rolling core and the upper and lower bearing plates of the RNC isolator prototypes. This means that the rolling core and the upper and lower bearing plates are maintained always in contact through the upper and lower rubber or compressible neoprene plates, respectively. The RNC isolator is subjected to a gradually increasing vertical tension, at the same rate of axial compression loading, until a separation between the upper bearing plate and the rolling body is just to be detected. The peak vertical tensile displacement of the RNC isolator prototypes are limited to the maximum cumulative compressibility of both upper and lower rubber or neoprene plates of the experimental prototypes. This test quantifies the amount of tension resistance provided by metallic yield dampers of the experimental prototypes.

In Fig. 5 the laboratory resulting data are reported in terms of displacement-time and force-time, while Fig. 6 depicts the results as displacement-force. Force positive sign means tension, while negative sign means compression.

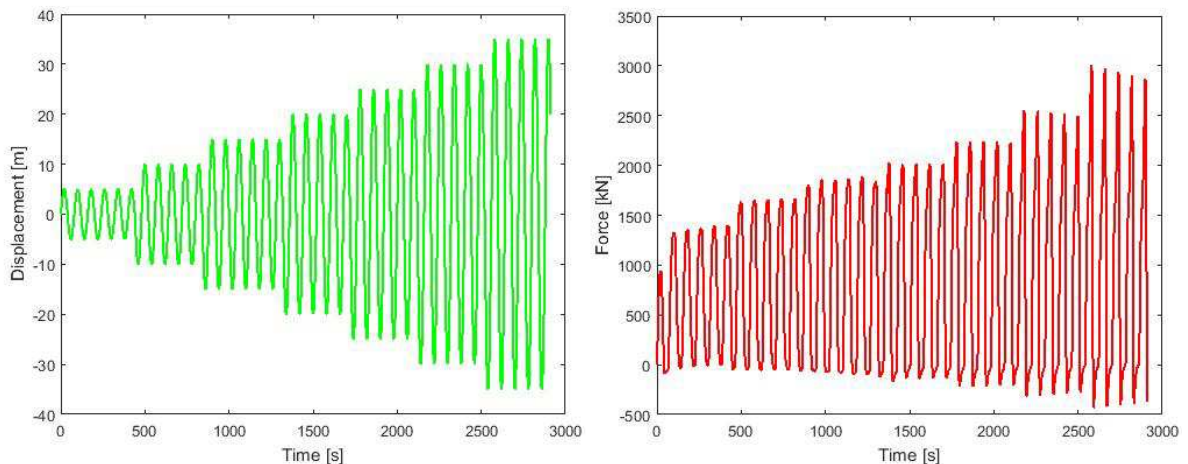

Figure 5 – Displacement input and force output time histories.

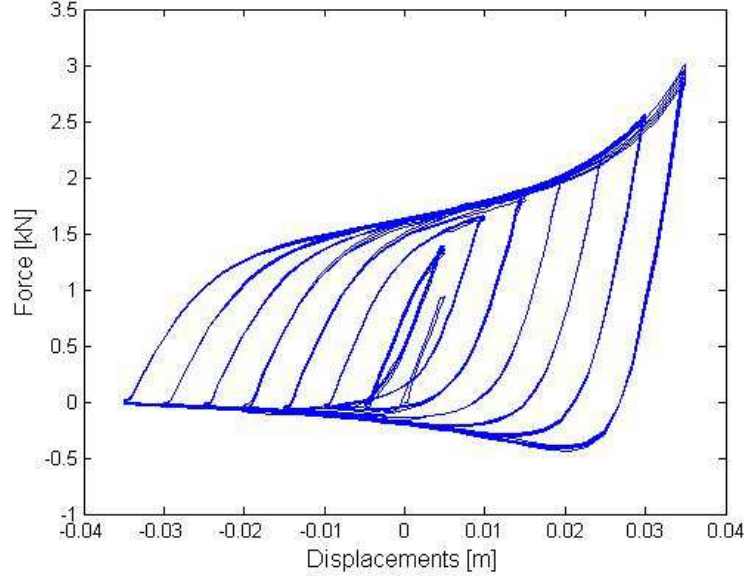

Figure 6 – Laboratory data in terms of displacement-force.

#### 4 AXIAL RNC MODEL

For modelling the RNC axial response, coming from the laboratory data as reported in the previous section, the Bouc-Wen models class has been considered. In general, such formulations are able to describe smooth hysteretic behaviour in time history and random vibration analyses. This study proposes a modified Bouc-Wen model by implementing suitable scaling functions able to fit the asymmetric hysteresis loops.

For a structural element characterized by a Bouc-Wen class model, the resisting force is evaluated by Eq. (1):

$$f_s(x, \dot{x}, z) = \alpha k_0 x + (1 - \alpha) k_0 z \quad (1)$$

where  $x$  denotes the displacement,  $x$  with dot denotes the velocity,  $\alpha$  is the post- to pre-yielded stiffness ratio,  $k_0$  is the initial stiffness and  $z$  represents as auxiliary variable the inelastic behaviour. The derivative of this last variable can be determined by Eq. (2):

$$\dot{z} = \frac{\dot{x}}{\eta} [A - v|z|^n \Psi(x, \dot{x}, z)] \quad (2)$$

in which a dot denoted the derivative with respect to time,  $A$  and  $n$  are parameters controlling the scale and the sharpness of the hysteresis loops respectively,  $\eta$  controls the pre-yielding stiffness,  $v$  governs the ultimate strength and  $\Psi$  defines a nonlinear function which governs the shape of the loops.

For the function  $\Psi$  the model by Wang and Wen [4] is considered (Eq. (3)):

$$\Psi(x, \dot{x}, z) = \gamma + \beta \operatorname{sgn}(\dot{x}z) + \Phi[\operatorname{sgn}(\dot{x}) + \operatorname{sgn}(z)] \quad (3)$$

where  $\gamma$  and  $\beta$  are parameters governing the shape of the model and  $\Phi$  is a parameter that accounts for the asymmetric peak restoring force in the Wang-Wen model, for which the displacement  $x$  does

not appear in the function  $\Psi$ . Therefore such function controls the slope of the hysteresis loop through four phases, different due to the signs of  $\dot{x}$  and  $z$ .

Owing to the strong asymmetry of the RNC axial response and the strong hardening behaviour reloading from compression to tension (from negative displacements to positive displacements in Fig. 5), the standard Wang-Wen model resulted not able to fit completely the laboratory outcomes. Thus, scaling functions have been introduced respectively for positive and negative reaction forces.

The proposed modified Wang-Wen model fits the experimental axial response of the RNC device if the parameters in Table 1 are adopted. These were users identified.

*Table 1: Parameters of the proposed model*

<b>Parameter</b>	<b>Value</b>
$\alpha$	0.001
$\beta$	40
$\gamma$	40
$k_0$	100 [kN/m]
$\Phi$	-25
$n$	1
$A$	1
$\nu$	1.4
$\eta$	0.35

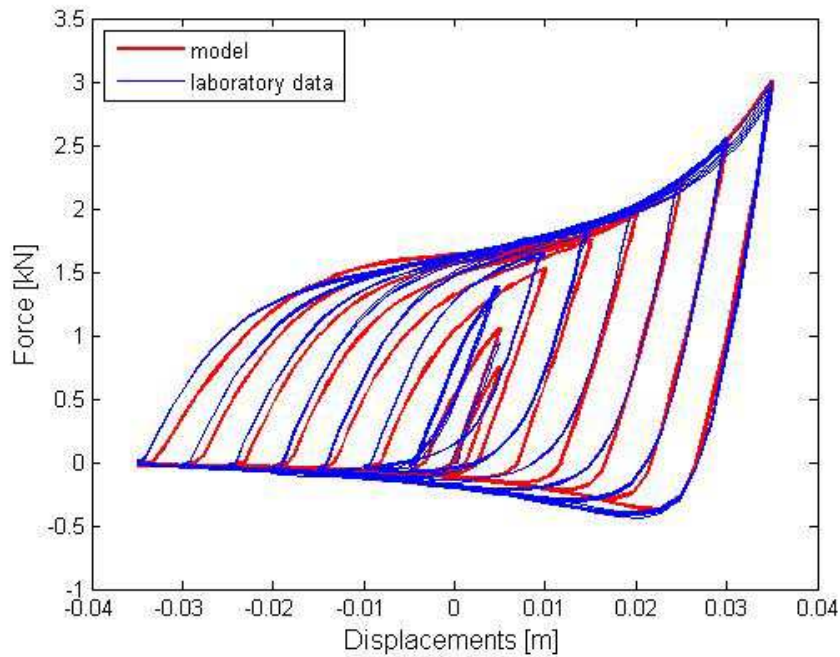

*Figure 7 – Comparison between laboratory data and presented model in terms of displacement-force.*

Fig. 7 depicts the comparison in terms of axial force – displacement cycles between the laboratory outcomes and the proposed model.

## 5 CONCLUSION

This research work is devoted to describe laboratory tests on the axial behaviour of the RNC isolation device. As final part of this work, a numerical model from the Bouc-Wen class type is proposed to fit the strong asymmetric hysteresis response of the device.

The physical model of the RNC device is successfully tested using a Hexapod-based laboratory facility in unidirectional axial loading paths, confirmed the specific characteristics of the prototypes, as were identified by previous design studies.

The analyses by using the proposed numerical model satisfactorily reproduce the axial signature of the device by introducing suitable scaling functions. They are able to follow the strong asymmetry and the huge hardening behaviour of the tensile force.

## ACKNOWLEDGEMENT

Financial support for the experimental set up is appreciated from the Spanish Ministry of Economy and Competitiveness through project DPI2011-28033-C03-01.

## REFERENCES

- [1] Ismail, M. An innovative isolation device for aseismic design. *PhD thesis* 2009; Doctoral program: Earthquake Engineering and Structural Dynamics, Technical University of Catalonia, Barcelona, Spain. (<http://www.tdx.cat/handle/10803/6265>), accessed 10th May 2014 20:08.
- [2] Ismail, M., Rodellar, J., Carusone, G., Domaneschi, M., Martinelli, L. Characterization, modeling and assessment of Roll-N-Cage isolator using the cable-stayed bridge benchmark, *Acta Mechanica*, 2013; **224**:525–547. DOI: 10.1007/s00707-012-0771-4.
- [3] De Mari, G., Domaneschi, M., Ismail, M., Martinelli, L., Rodellar, J. Reduced-order coupled bidirectional modeling of the Roll-N-Cage isolator with application to the updated bridge benchmark, *Acta Mechanica*, 2015; **226**(10):3533-3553. DOI: 10.1007/s00707-015-1394-3
- [4] Wang, C.H., Wen, Y.K. Reliability and redundancy of pre-northridge low-rise steel building under seismic excitation, *Rep. No. UILU-ENG-99-2002*, 1998; Univ. Illinois at Urbana-Champaign, Champaign, Ill, USA.
- [5] Song, J., Der Kiureghian, A. Generalized Bouc–Wen Model for Highly Asymmetric Hysteresis, *Journal of Engineering Mechanics ASCE*, 2006; **132**(6): 610–618.
- [6] MATLAB. Release R2013a user manual, MATLAB, Natick, Massachusetts, 2013.
- [7] Ismail, M., Rodellar, J. *A mechanical extension for Stewart platform (Hexapod)*. Patent No. P201331348, Spanish Office of Patents and Marks, 2013.
- [8] Ismail, M., Rodellar, J., Experimental investigations of a rolling-based seismic isolation system, *Journal of Vibration and Control*, 2016, Accepted for publication, DOI:10.1177/1077546316640664