

CF005 MANUAL CHAIN HOIST



RED ROOSTER LIFTING

STANDARD FEATURES

- ▷ Lightweight aluminium body
- ▷ Precise gear mechanism
- ▷ Long lasting sealed bearings
- ▷ Nickel-plated load chain grade V (G100)
- ▷ Made in Japan

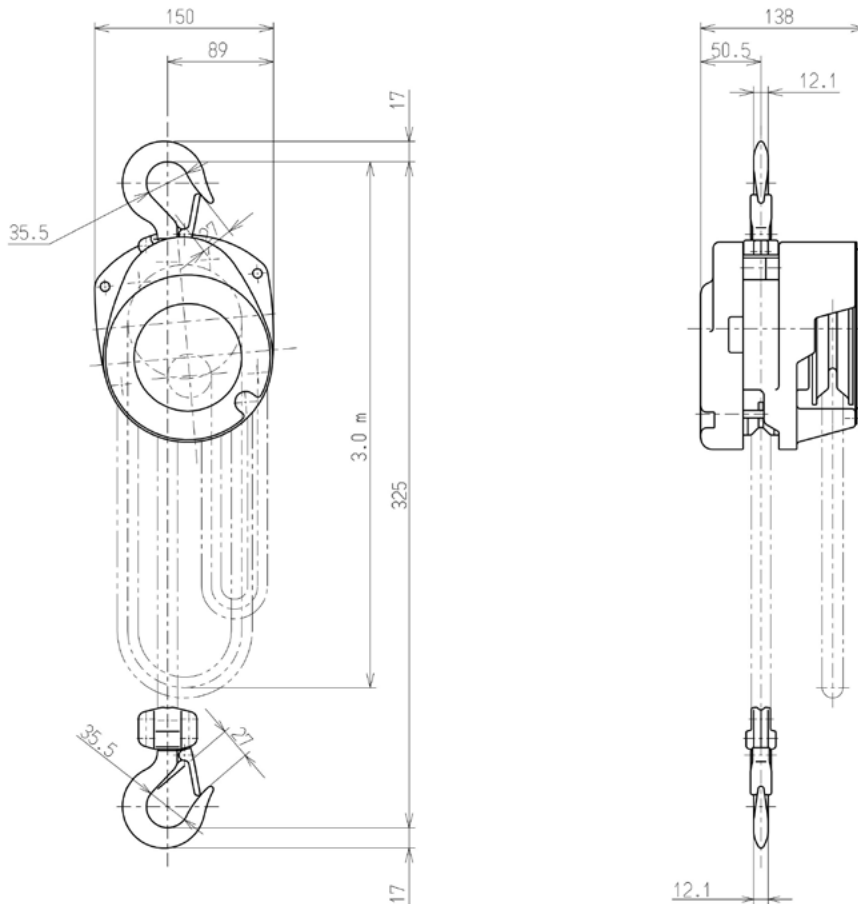

All measurements are in mm

MODEL	CF005
WLL	500 kg
STANDARD LIFT	3 m
HAND PULL TO LIFT FULL LOAD	30.0 daN
LOAD CHAIN DIAMETER	5.0 x 15.1 mm
CHAIN FALL	1
NET WEIGHT	11.0 kg
WEIGHT PER ADDITIONAL METRE LIFT	1.5 kg

Information subject to change without notice



Image for illustration purposes only

KITO

RED ROOSTER LIFTING

Nauta House, The Meadows
Oldmeldrum, Aberdeenshire
United Kingdom, AB51 0EZ

T: +44 (0) 1651 872101
E: sales@redroosterlifting.com
W: www.redroosterlifting.com