

CF015 MANUAL CHAIN HOIST



RED ROOSTER LIFTING

STANDARD FEATURES

- ▷ Lightweight aluminium body
- ▷ Precise gear mechanism
- ▷ Long lasting sealed bearings
- ▷ Nickel-plated load chain grade V (G100)
- ▷ Made in Japan

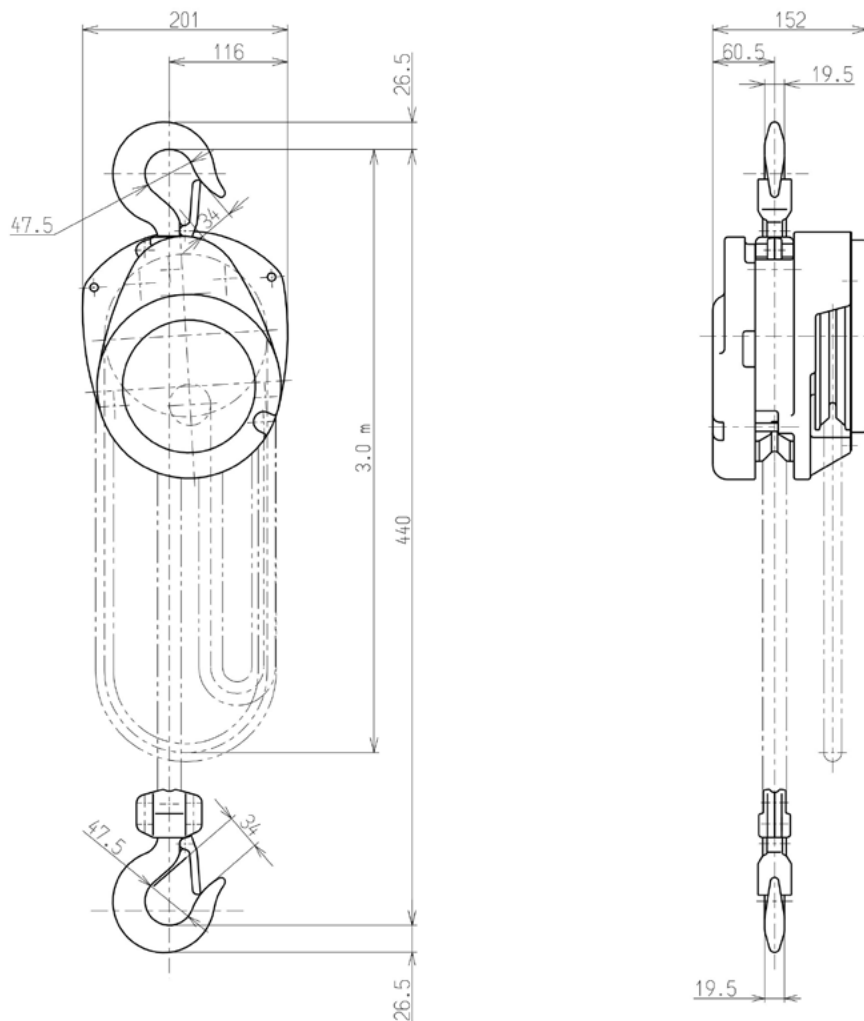

All measurements are in mm



Image for illustration purposes only

MODEL	CF015
WLL	1500 kg
STANDARD LIFT	3 m
HAND PULL TO LIFT FULL LOAD	42.0 daN
LOAD CHAIN DIAMETER	7.1 x 21.2 mm
CHAIN FALL	1
NET WEIGHT	18.0 kg
WEIGHT PER ADDITIONAL METRE LIFT	2.1 kg

Information subject to change without notice

KITO

RED ROOSTER LIFTING
Nauta House, The Meadows
Oldmeldrum, Aberdeenshire
United Kingdom, AB51 0EZ

T: +44 (0) 1651 872101
E: sales@redroosterlifting.com
W: www.redroosterlifting.com