

CB010 MANUAL CHAIN HOIST



RED ROOSTER LIFTING

STANDARD FEATURES

- ▷ Screw-and-disc type load brake
- ▷ Double pawl spring
- ▷ Nickel-plated load chain grade V (G100)
- ▷ Made in Japan

AVAILABLE OPTIONS

- ▷ Geared trolley
- ▷ Plain trolley
- ▷ Overload limiter
- ▷ Canvas chain bucket
- ▷ ATEX

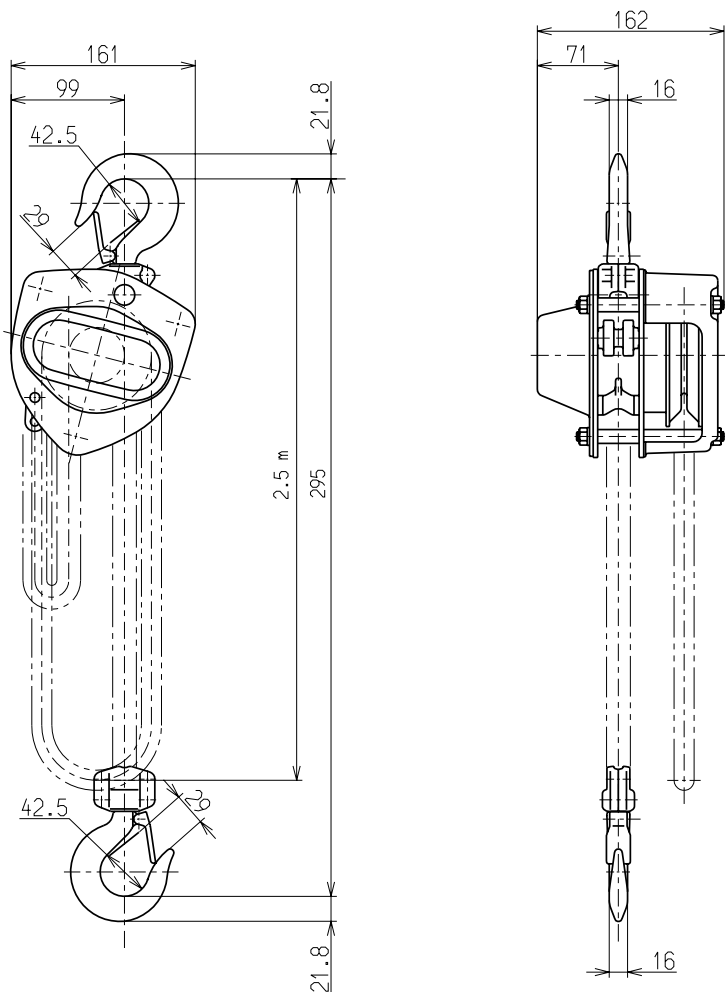

All measurements are in mm



Image for illustration purposes only

MODEL	CB010
WLL	1000 kg
STANDARD LIFT	3 m
HAND PULL TO LIFT FULL LOAD	28.4 daN
LOAD CHAIN DIAMETER	6.3 x 19.1 mm
CHAIN FALL	1
NET WEIGHT	12.5 kg
WEIGHT PER ADDITIONAL METRE LIFT	1.8 kg

Information subject to change without notice

KITO

RED ROOSTER LIFTING
Nauta House, The Meadows
Oldmeldrum, Aberdeenshire
United Kingdom, AB51 0EZ

T: +44 (0) 1651 872101
E: sales@redroosterlifting.com
W: www.redroosterlifting.com