

CB400 MANUAL CHAIN HOIST



RED ROOSTER LIFTING

STANDARD FEATURES

- ▷ Screw-and-disc type load brake
- ▷ Double pawl spring
- ▷ Nickel-plated load chain grade V (G100)
- ▷ Made in Japan

AVAILABLE OPTIONS

- ▷ Geared trolley
- ▷ Plain trolley
- ▷ Overload limiter
- ▷ Canvas chain bucket
- ▷ ATEX

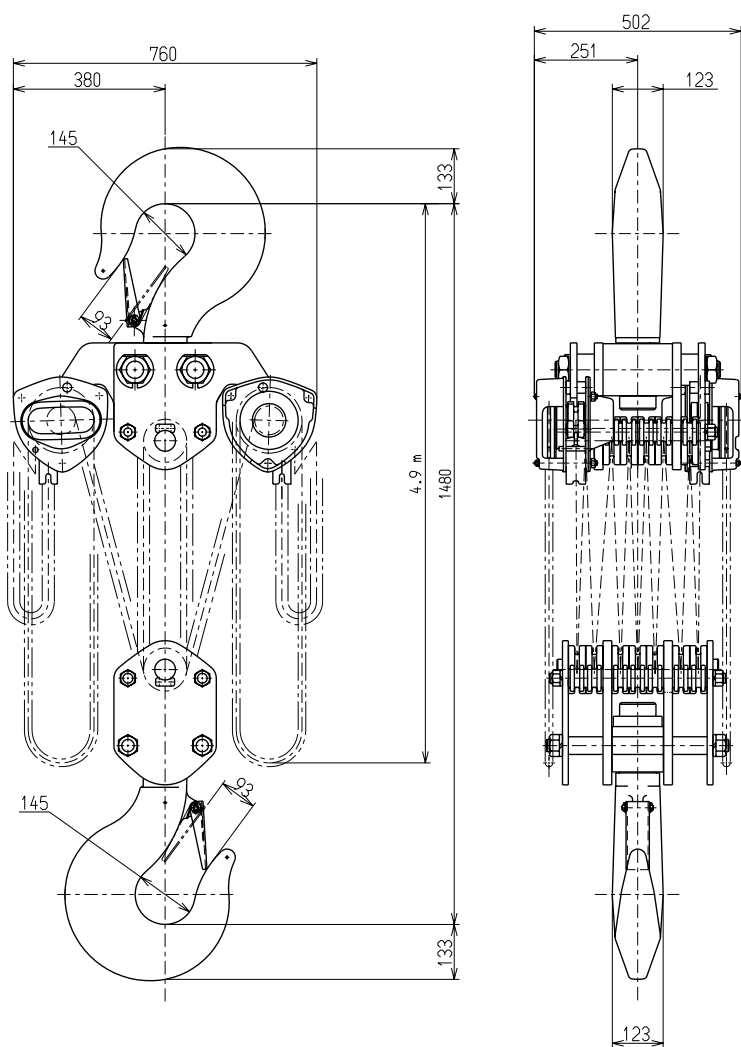

All measurements are in mm

MODEL	CB400
WLL	40000 kg
STANDARD LIFT	3.5 m
HAND PULL TO LIFT FULL LOAD	2 x 42.1 daN
LOAD CHAIN DIAMETER	9.0 x 27.2 mm
CHAIN FALL	14
NET WEIGHT	480.0 kg
WEIGHT PER ADDITIONAL METRE LIFT	26.2 kg

Information subject to change without notice



Image for illustration purposes only

KITO

RED ROOSTER LIFTING

Nauta House, The Meadows
Oldmeldrum, Aberdeenshire
United Kingdom, AB51 0EZ

T: +44 (0) 1651 872101
E: sales@redroosterlifting.com
W: www.redroosterlifting.com