

CB030 ATEX ATEX MANUAL CHAIN HOIST



RED ROOSTER LIFTING

STANDARD FEATURES

- ▷ Screw-and-disc type load brake
- ▷ Double pawl spring
- ▷ Nickel-plated load chain grade V (G100)
- ▷ Group II 2 GDc IIB T4 135°C
- ▷ Operating temp -40°C to +30°C
- ▷ Made in Japan

AVAILABLE OPTIONS

- ▷ Geared trolley
- ▷ Plain trolley
- ▷ Overload limiter
- ▷ Canvas chain bucket

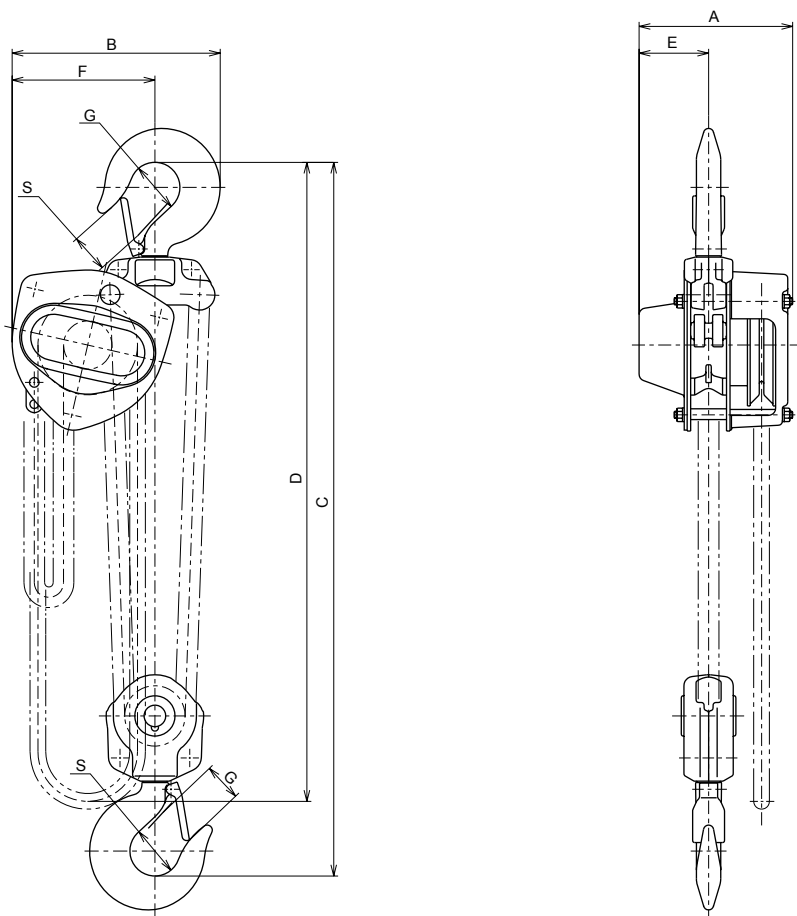

MODEL	HEADROOM C	A	B	D	E	F	G	S
CB030 ATEX	600	192	282	3600	91	194	46.5	63.0

All measurements are in mm

MODEL	CB030 ATEX
WLL	3000 kg
STANDARD LIFT	3.5 m
HAND PULL TO LIFT FULL LOAD	35.3 daN
LOAD CHAIN DIAMETER x CHAIN FALL	9.0 x 27.2 mm
CHAIN FALL	2
NET WEIGHT	41.0 kg
WEIGHT PER ADDITIONAL METRE LIFT	4.4 kg

Information subject to change without notice

KITO

RED ROOSTER LIFTING

Nauta House, The Meadows
Oldmeldrum, Aberdeenshire
United Kingdom, AB51 0EZ

T: +44 (0) 1651 872101
E: sales@redroosterlifting.com
W: www.redroosterlifting.com