

SHB050 | 5 TONNE ULTRA LOW HEADROOM MANUAL CHAIN HOIST



**RED ROOSTER
LIFTING**

RAISING EXPECTATIONS

The SHB050 is a 5 tonne ultra low headroom manual chain hoist for use in tight spaces. This model is just part of Red Rooster Lifting's full range of KITO equipment available.



The SHB ultra low headroom series of manual chain hoists are one of the lowest headroom manual chain blocks on the market. It's extremely low-profile body makes it ideal for demanding industrial lifting applications where space is limited.

The unit has an impact-resistant gear housing, double ratchet springs, a precision gearbox and double casing for protection against dust and water. With premium-grade components for long life in the tightest industrial and contracting applications. The capacities range from 1 tonne to 10 tonne dependant on your lifting needs.

STANDARD FEATURES

- Short headroom with integrated hook
- Shock resistant double gear casing
- Precision gearing
- Efficient drive train
- High performance mechanical brake
- Sealed maintenance free bearings
- Fall protection device and rubber bumpers
- Nickel-plated load chain grade T series V (G100)
- Made in Japan

AVAILABLE OPTIONS

- 2 different flange ranges available
- Overload protection device
- ATEX

Image for illustration purposes only

T: +44 (0) 1651 872101
sales@redroosterlifting.com

REDROOSTERLIFTING.COM

KITO

SHB050 | 5 TONNE ULTRA LOW HEADROOM MANUAL CHAIN HOIST



**RED ROOSTER
LIFTING**

RAISING EXPECTATIONS

DIMENSIONS

All measurements are in mm
Information subject to change without notice

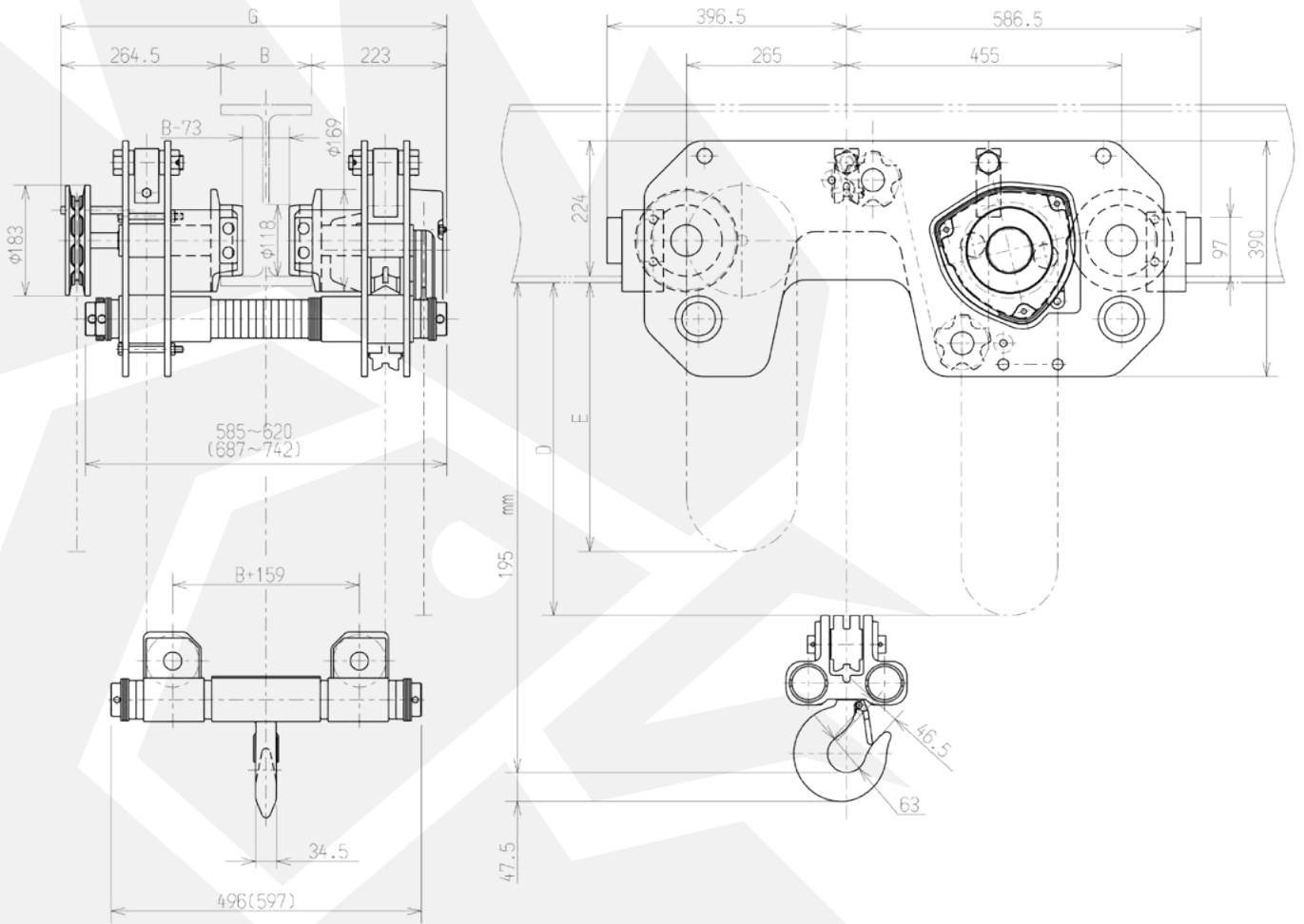

MODEL	WLL	CHAIN FALL	CHAIN PULL TO LIFT FULL LOAD	HEADROOM
SHB050	5000 kg	2	44.1 daN	195 mm
MODEL	LOAD CHAIN DIA	STANDARD HOL	NET WEIGHT	WEIGHT FOR ADDITIONAL M HOL
SHB050	9.0 x 27.2 mm	3.0 m	280 kg	5.4 kg

KITO