

SHB050 LOW HEADROOM MANUAL CHAIN HOIST



RED ROOSTER LIFTING

STANDARD FEATURES

- ▷ Shock resistant gear case
- ▷ High performance brake
- ▷ Short headroom integrated hook
- ▷ Nickel-plated load chain grade V (G100)
- ▷ Made in Japan

AVAILABLE OPTIONS

- ▷ Overload limiter
- ▷ Canvas chain bucket
- ▷ ATEX

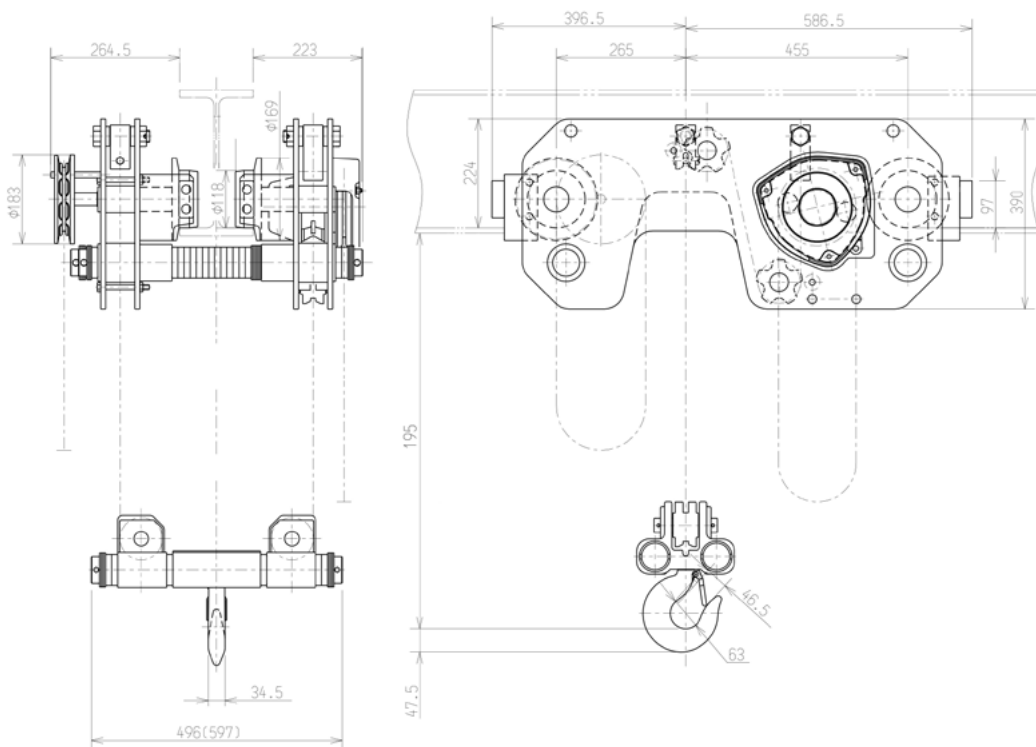
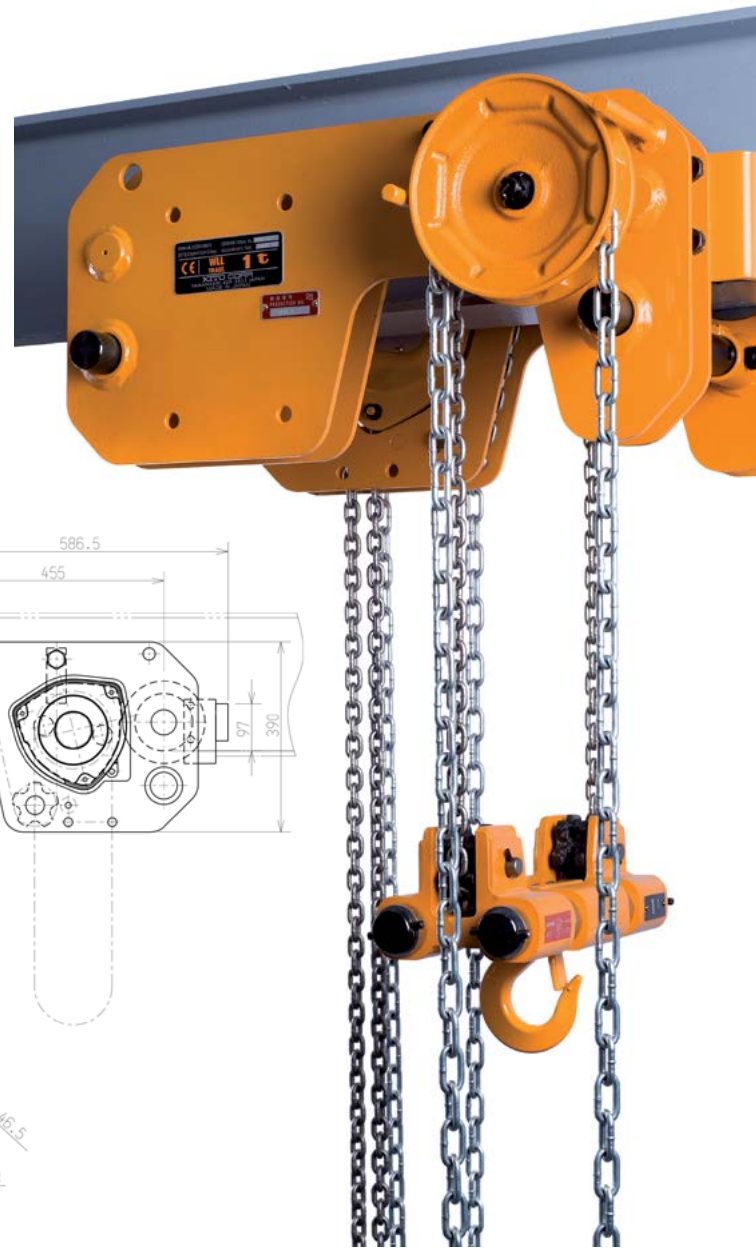

All measurements are in mm

Image for illustration purposes only

MODEL	SHB050
WLL	5000 kg
STANDARD LIFT	3 m
HAND PULL TO LIFT FULL LOAD - HOIST	44.1 daN
HAND PULL TO LIFT FULL LOAD - TROLLEY	4.5 daN
LOAD CHAIN DIAMETER	9.0 x 27.2 mm
CHAIN FALL	2
NET WEIGHT	280.0 kg
WEIGHT PER ADDITIONAL METRE LIFT	5.4 kg

Information subject to change without notice

KITO

RED ROOSTER LIFTING

Nauta House, The Meadows
Oldmeldrum, Aberdeenshire
United Kingdom, AB51 0EZ

T: +44 (0) 1651 872101
E: sales@redroosterlifting.com
W: www.redroosterlifting.com