

ED06S- ED06ST ELECTRIC CHAIN HOIST



RED ROOSTER LIFTING

STANDARD FEATURES

- ▷ 230V contactor control
- ▷ Protection class IP54
- ▷ Upper limit switch
- ▷ Preselected lifting speed
- ▷ Plastic chain bucket

AVAILABLE OPTIONS

- ▷ Geared trolley
- ▷ Plain trolley
- ▷ Plain mini trolley
- ▷ Canvas chain bucket up to 70m
- ▷ Steel chain bucket
- ▷ Radio remote control

KITO

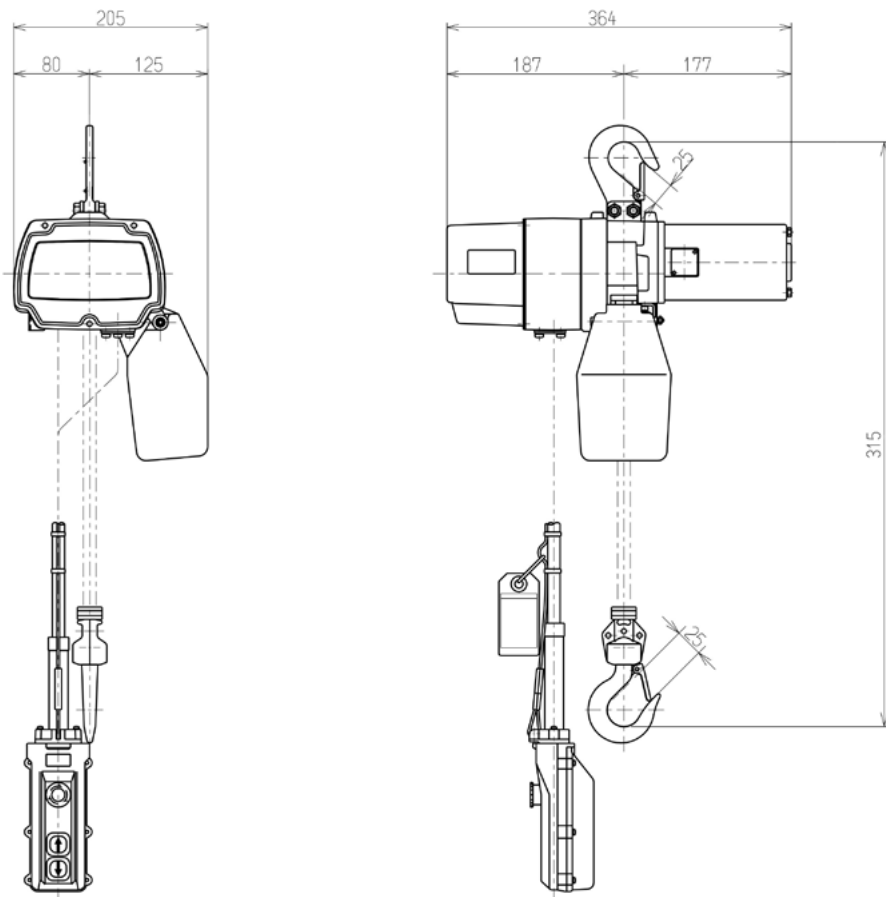

All measurements are in mm

Image for illustration purposes only

MODEL	WLL (KG)	LIFTING MOTOR		LIFTING SPEED M/MIN		LOAD CHAIN			CLASS ISO / FEM	NET WEIGHT (KG)	WEIGHT PER EXTRA METRE HOL (KG)
		OUTPUT (kW)	RATING (%)	50Hz		DIA (MM)	x	CHAIN FALLS			
				HIGH	LOW						
ED06S	60	0.3	30	20.1	-	4.0	x	1	1Am	11.5	0.4
ED06ST	60	0.3	30	20.1	4.0	4.0	X	1	1Am	12	0.4

Information subject to change without notice

RED ROOSTER LIFTING

Nauta House, The Meadows
Oldmeldrum, Aberdeenshire
United Kingdom, AB51 0EZ

T: +44 (0) 1651 872101
E: sales@redroosterlifting.com
W: www.redroosterlifting.com