

# EDC18SD - DUAL SPEED ELECTRIC CHAIN HOIST



# RED ROOSTER LIFTING

## STANDARD FEATURES

- ▷ 230V contactor control
- ▷ Protection class IP44
- ▷ Upper limit switch
- ▷ Variable lifting speed
- ▷ High-performance mechanical load brake
- ▷ Plastic chain bucket

## AVAILABLE OPTIONS

- ▷ Geared trolley
- ▷ Plain trolley
- ▷ Plain mini trolley

# KITO

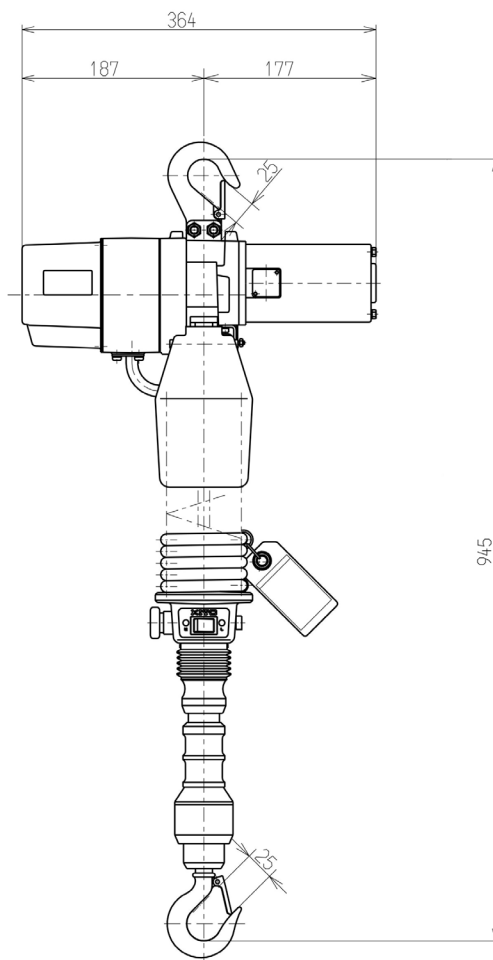
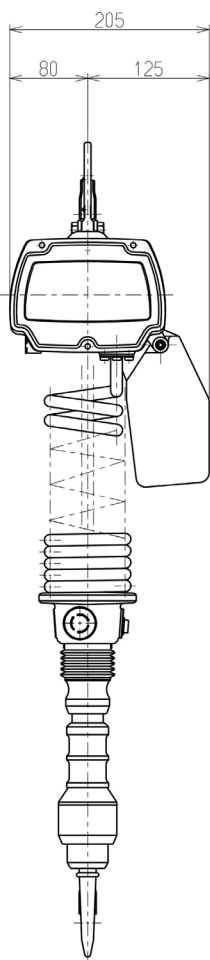

All measurements are in mm

MODEL	WLL (KG)	LIFTING MOTOR		LIFTING SPEED M/MIN		LOAD CHAIN		
		OUTPUT (kW)	RATING (%)	50Hz		DIA (MM)	x	CHAIN FALLS
				HIGH	LOW			
EDC18SD	180	0.3	20	7.7	3.0	4.0	x	1
	CLASSIFICATION ISO / FEM			NET WEIGHT (KG)		HEIGHT OF LIFT (M)		
	1Am			14.5		1.8		

Information subject to change without notice

Image for illustration purposes only