



**RED ROOSTER
LIFTING**

RAISING EXPECTATIONS

TMH-9000/3-AT10S AIR HOIST & TROLLEY

The **TMH-9000/3-AT10S** is a 9 tonne chain hoist and trolley from Red Rooster Lifting. This is part of our air hoist and trolley range for lifting equipment applications in industry.

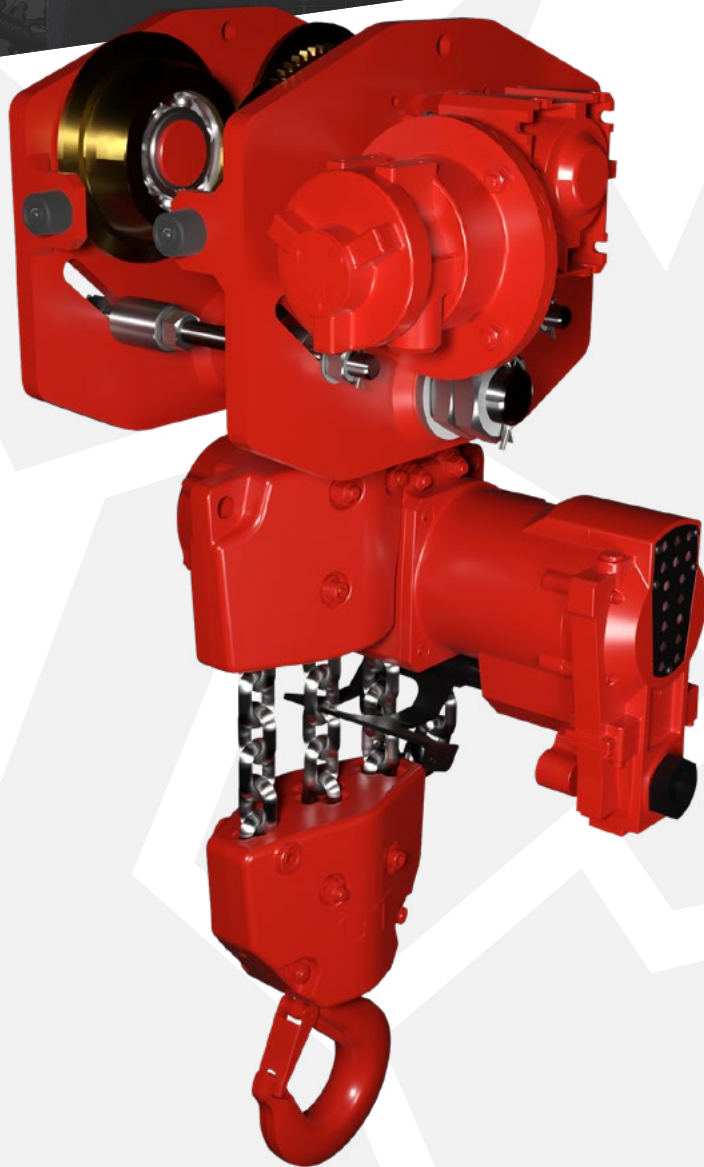

The new **Red Rooster Lifting** TMH series air hoist and trolleys have the highest lifting speed with the lowest headroom on the hoist market. The TMH hoists are designed to operate at full lifting capacity with an air pressure from 4 – 6.3 bar. For full speed operation the hoist air pressure should be 6.3 bar.

STANDARD FEATURES

- Toku rotary vane motor
- ATEX zone 2 specification
- Robust 3 step planetary gearbox
- Failsafe automatic internal disc brake
- Choice of pendant controls or control stations
- Mechanical upper & lower switches
- Cast steel housing
- Internal silencing down to 80 dB(A)
- Alloy safety swivel hooks with safety catch
- Load chain 13 x 36mm of European manufacture to EN818-7
- Automatic load limiter
- Trolley to suit various flange profiles
- Anti-tilt & anti-drop plates
- High efficiency motor gearbox
- Heavy duty sealed wheel bearings
- Wheel profile to suit parallel or tapered flanges

AVAILABLE OPTIONS

- Marine specification
- Special paint systems
- Collision bumpers
- Corrosion protection
- ATEX zone 1 specification
- Chain collectors (galvanised or stainless steel)
- Articulated trolley
- Low headroom units
- Rack & pinion drive
- Travel limits
- Air service units
- Festoon systems
- Radio control remote
- Optional travel speeds
- Beam brake



**ATEX ZONE 2
AS STANDARD**

T: +44 (0) 1651 872101
sales@redroosterlifting.com

REDROOSTERLIFTING.COM

Red Rooster Lifting Limited Nauta House, The Meadows, Oldmeldrum, Inverurie, Aberdeenshire, UK, AB51 0EZ



TMH-9000/3-AT10S AIR HOIST & TROLLEY

**RED ROOSTER
LIFTING**

RAISING EXPECTATIONS

DIMENSIONS

All measurements are in mm
Information subject to change without notice

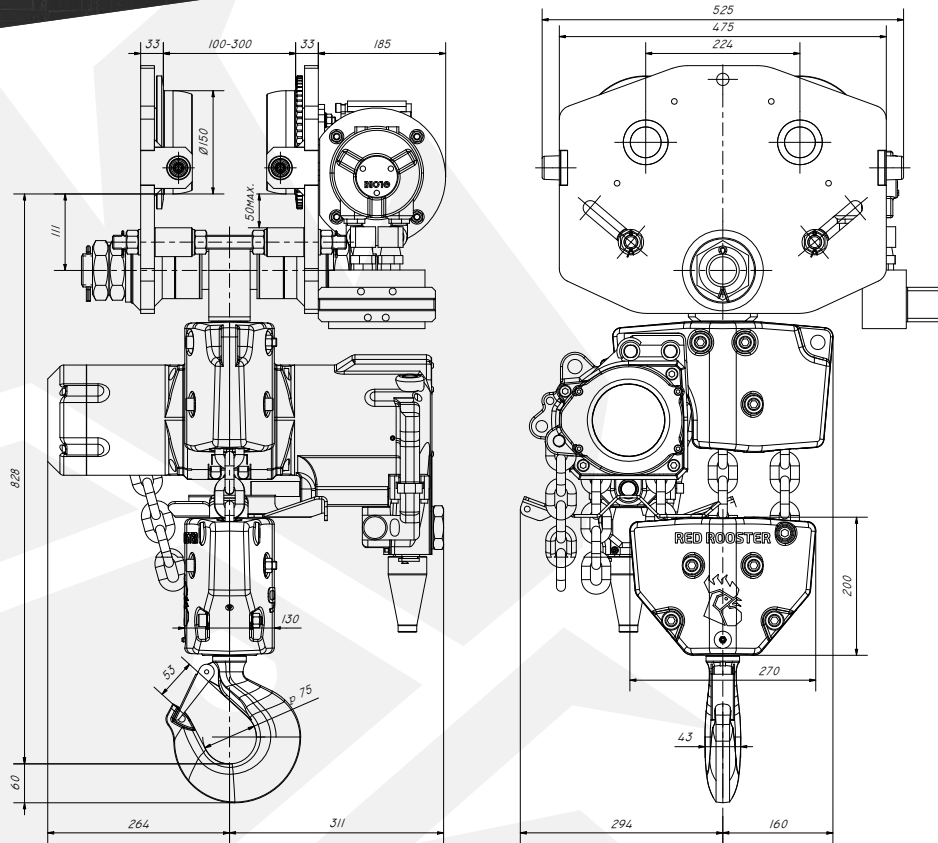

HOIST MODEL	TMH-9000/3-AT10S	TROLLEY MODEL	AT10S
WLL	9000 kg	G.A. DRAWING	1503-28
CHAIN FALLS	3	FLANGE	110-180
LIFTING SPEED FULL LOAD	1.8 m/min	RANGE 1	180-240
LIFTING SPEED WITHOUT LOAD	3.6 m/min	RANGE 2	240-300
MAX AIR CONSUMPTION (L/SEC)	68	RANGE 3	
WORKING PRESSURE	4 - 6 Bar	STANDARD TROLLEY TEMP RANGE	-10 to +50°C
AIR CONNECTION	1" BSP	OPTIONAL TROLLEY TEMP RANGE	-20 to +70°C
MINIMUM HOSE DIA.	3/4"	TRAVEL SPEED (M/MIN)	8
AIR SERVICE UNIT	1" FLR	WHEEL MATERIAL	Steel
WEIGHT 3M HOL & TROLLEY	314 kg	ATEX WHEEL MATERIAL	Bronze
ADDITIONAL METRE HOL	11.4 kg	MINIMUM BEND RADIUS (M)	2.5
		NUMBER OF WHEELS	4
		DRIVEN WHEELS	2
		MAX AIR CONSUMPTION	40 l/sec
		HOSE ID TROLLEY	3/4"

AT_S = STANDARD AT_ATX = ATEX

T: +44 (0) 1651 872101
sales@redroosterlifting.com