

CB400 | 40 TONNE MINING / OFFSHORE MANUAL CHAIN HOIST



**RED ROOSTER
LIFTING**

RAISING EXPECTATIONS

The **CB400** is a 40 tonne robust manual chain hoist designed for mining and offshore industry. This model is just part of Red Rooster Lifting's full range of KITO equipment available.



The CB mining / offshore series of manual chain hoists are robust with shock-resistant casing, sealed bearings to protect against dust and water, and with premium-grade components for long life in the toughest industrial and contracting applications. The capacities range from 500 kg to 50 tonne dependant on your lifting needs.

They have twin pawls with a double spring system as an additional safety feature, an overload limiter, precision gears, a secure and reliable mechanical brake, load chain guide and a nickel-plated load chain with long service life. The load chain has a break strength of 1,000 N/mm² and corresponds to grade T series V according to DIN EN 818-7.

STANDARD FEATURES

- Robust mechanical brake
- Heavy duty safety catch
- Shock resistant double gear casing
- Twin pawls with double spring system
- Overload limiter
- Cap nuts
- Sealed maintenance free bearings
- Nickel-plated load chain grade T series V (G100)
- Made in Japan

AVAILABLE OPTIONS

- Geared trolley
- Plain trolley
- Without overload limiter
- Chain collector
- ATEX

Image for illustration purposes only

T: +44 (0) 1651 872101
sales@redroosterlifting.com

REDROOSTERLIFTING.COM

KITO

CB400 | 40 TONNE MINING / OFFSHORE MANUAL CHAIN HOIST



**RED ROOSTER
LIFTING**

RAISING EXPECTATIONS

DIMENSIONS

All measurements are in mm
Information subject to change without notice

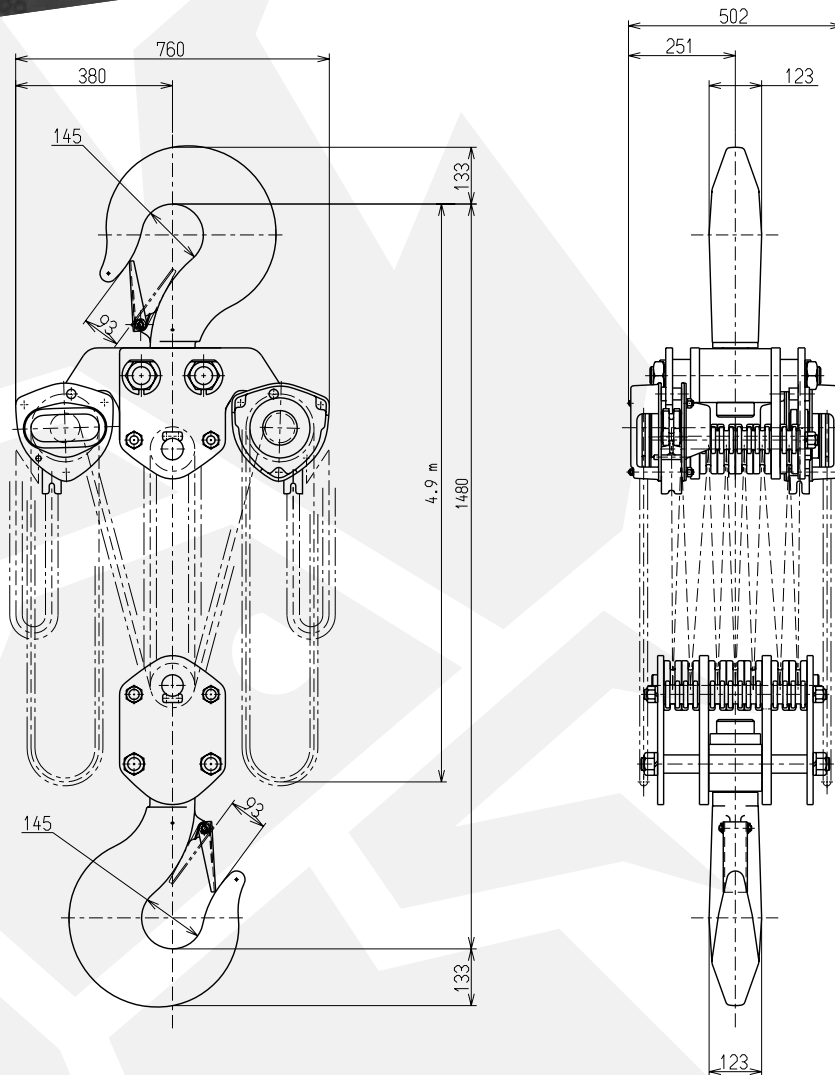

MODEL	WLL	CHAIN FALL	CHAIN PULL TO LIFT FULL LOAD	HAND CHAIN LENGTH FOR LIFTING
CB400	40,000 kg	14	42.1 x 2 daN	693 x 2 m
MODEL	LOAD CHAIN DIA	STANDARD HOL	NET WEIGHT	WEIGHT FOR ADDITIONAL M HOL
CB400	9.0 x 27.2 mm	3.5 m	480 kg	26.2 kg

KITO