

CB025 | 2.5 TONNE HIGH SPEED MANUAL CHAIN HOIST

The **CB025** is a 2.5 tonne high speed manual chain hoist for heavy duty applications, with industry-leading quality. This model is part of Red Rooster Lifting's full range of KITO equipment available.



**RED ROOSTER
LIFTING**

RAISING EXPECTATIONS



The CB high speed series of manual chain hoists are built with premium-grade components for long life in the toughest industrial and contracting applications. The capacities range from 2.5 tonne to 50 tonne dependant on your lifting needs.

This high speed model is 7 times faster than its standard CB model. This model has a revolutionary load sensing mechanism that provides the user with significant time and cost savings (reduced manpower by 3.5 times), improved worker productivity, reduced worker fatigue and higher worker safety

They have a shock-resistant gear casing, double ratchet spring, precision gears and double casing to protect against dust and water, with a secure and reliable mechanical brake, load chain guide and a nickel-plated load chain with break strength of 1,000 N/mm² and corresponds to class V according to DIN EN 818-7.

STANDARD FEATURES

- Mechanical brake
- Magnetic clutch
- High performance planetary gear system
- Impact resistant housing
- Double pawl double spring system
- Nickel-plated load chain grade V (G100)
- Made in Japan

AVAILABLE OPTIONS

- Geared or plain trolley
- Chain collector

Image for illustration purposes only

T: +44 (0) 1651 872101
sales@redroosterlifting.com

REDROOSTERLIFTING.COM

KITO

CB025 | 2.5 TONNE HIGH SPEED MANUAL CHAIN HOIST



**RED ROOSTER
LIFTING**

RAISING EXPECTATIONS

DIMENSIONS

All measurements are in mm
Information subject to change without notice

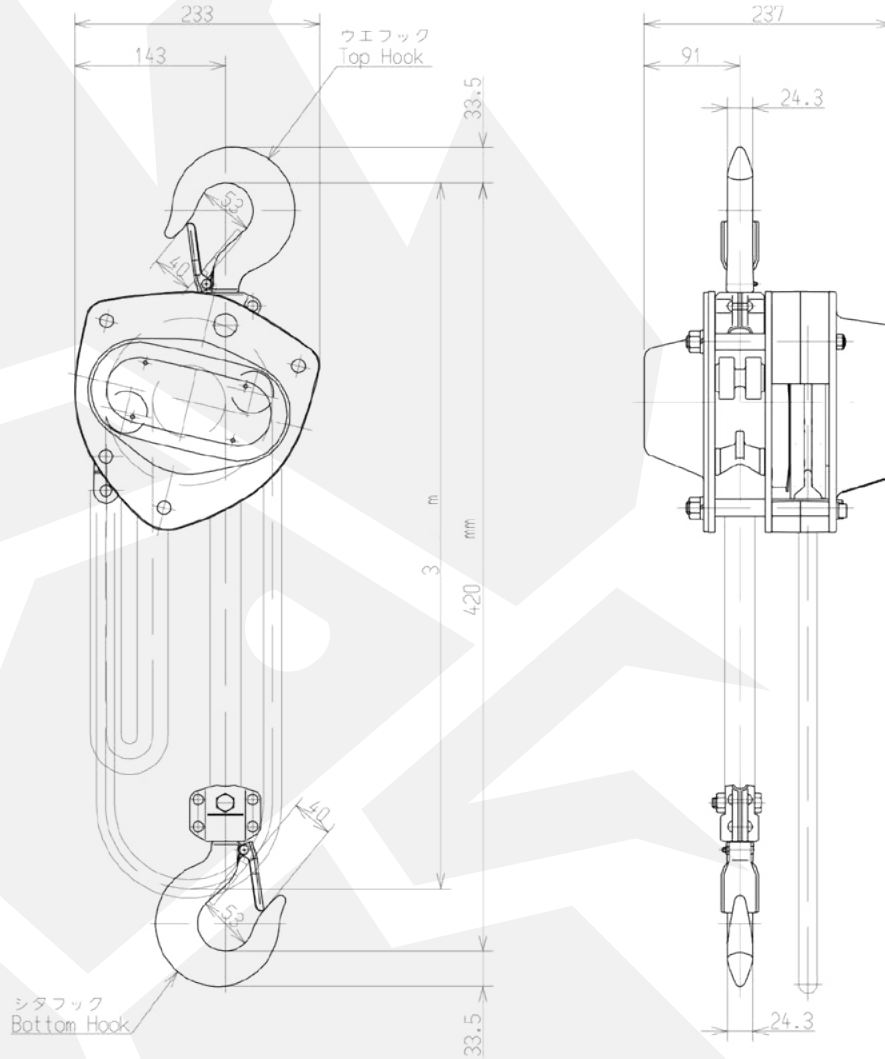

MODEL	WLL	CHAIN FALL	CHAIN PULL TO LIFT FULL LOAD	HAND CHAIN LENGTH FOR LIFTING PARTIAL LOAD	HAND CHAIN LENGTH FOR LIFTING FULL LOAD	
CB025	2500 kg	1	363 daN	14 m	99 m	
MODEL	LOAD CHAIN DIA	STANDARD HOL	MINIMUM SWITCHING LOAD	NET WEIGHT	WEIGHT FOR ADDITIONAL M HOL	
CB025	9.0 x 27.0 mm	3.0 m	250 kg <	34 kg	2.7 kg	

KITO