

TCS-980 AIR HOIST

The **TCS-980** is a 980 kg high speed chain hoist from Red Rooster Lifting. This is part of our air hoist hook suspension range for lifting equipment applications in industry.



**RED ROOSTER
LIFTING**

RAISING EXPECTATIONS

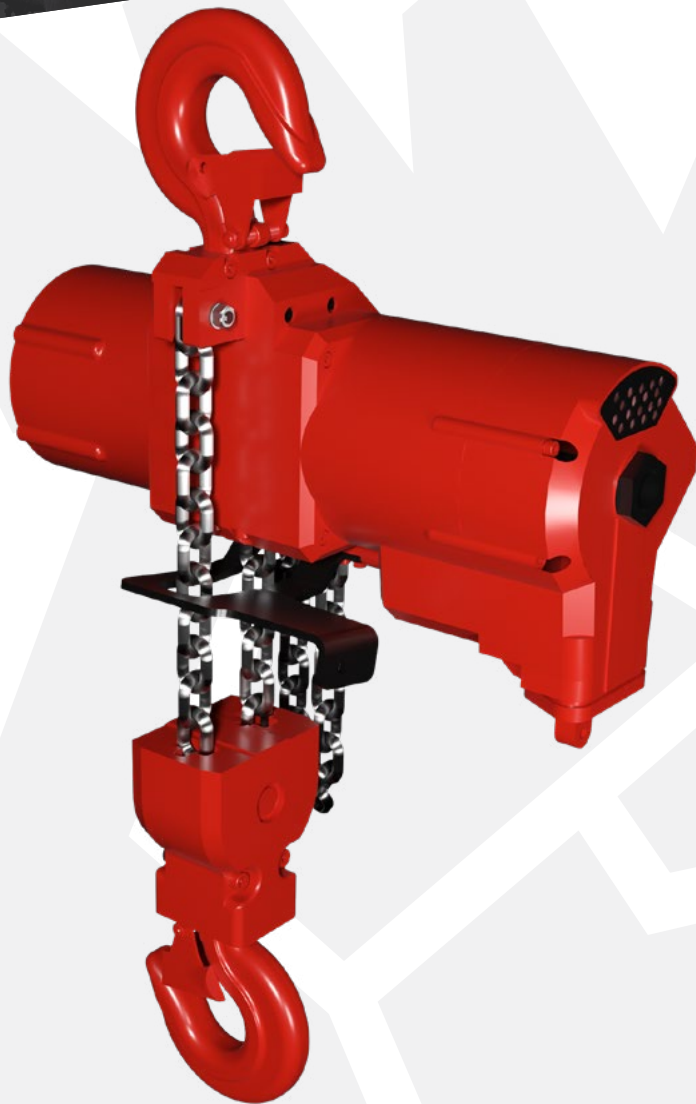

The **Red Rooster Lifting** TCS series of air hoists offers a range of high speed, lightweight lifting equipment suited to all types of industrial and marine environments. Red Rooster Lifting hoists are the perfect lifting solution for where the duty is high, or where a robust hoist is required to withstand harsh conditions. The hoists comply with the European Machinery Directive and are all CE marked.

STANDARD FEATURES

- Lightweight aluminium housing
- ATEX zone 2 specification
- Toku rotary vane motor
- Robust epicycle gearbox
- Failsafe automatic internal disc brake
- Mechanical upper & lower switches
- Aluminium housing
- Internal silencing down to 83 dB(A)
- Alloy safety swivel hooks with safety catch
- Load chain 6.3 x 19mm of European manufacture to EN818-7

AVAILABLE OPTIONS

- Marine specification
- Special paint systems
- Corrosion protection
- ATEX zone 1 specification
- Chain collectors (PVC, galvanised or stainless steel)
- Air Service units
- Festoon systems
- Radio control
- Main air shut off valve



**ATEX ZONE 2
AS STANDARD**

T: +44 (0) 1651 872101
sales@redroosterlifting.com

REDROOSTERLIFTING.COM

Red Rooster Lifting Limited Nauta House, The Meadows, Oldmeldrum, Inverurie, Aberdeenshire, UK, AB51 0EZ

TCS-980 AIR HOIST



**RED ROOSTER
LIFTING**

RAISING EXPECTATIONS

DIMENSIONS

All measurements are in mm
Information subject to change without notice

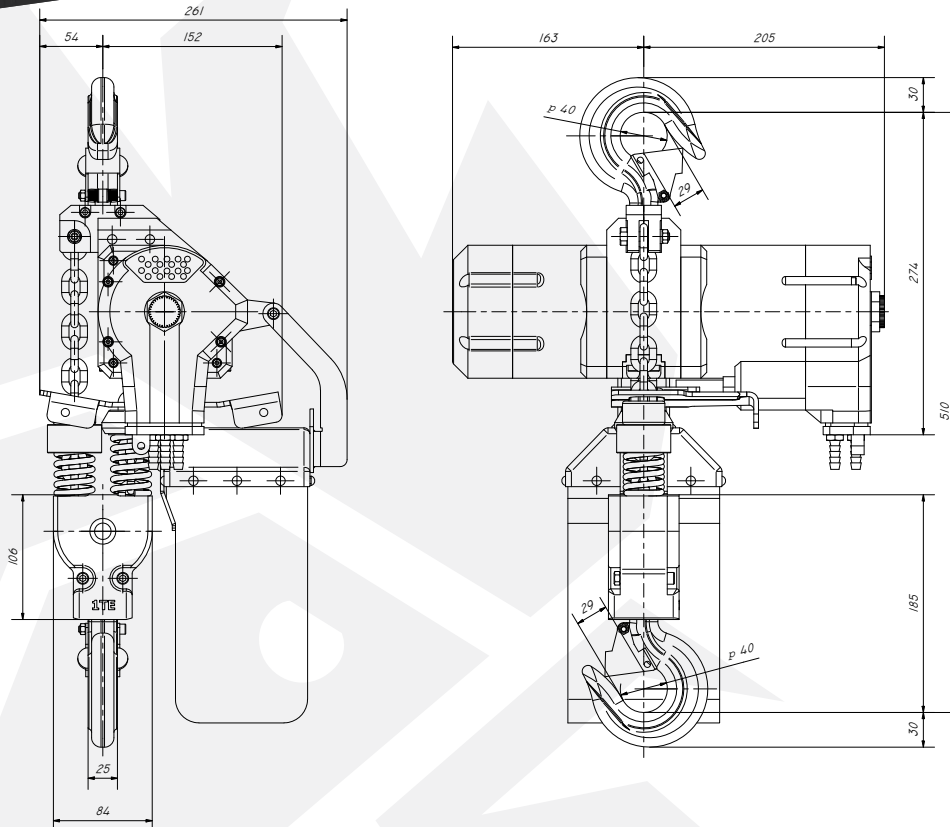

HOIST MODEL	TCS-980
WLL	980 kg
CHAIN FALLS	2
LIFTING SPEED WITH LOAD	8.5 m/min
LIFTING SPEED WITHOUT LOAD	17.0 m/min
LOWERING SPEED WITH LOAD	17.0 m/min
AIR CONSUMPTION LIFTING	28 l/sec
AIR CONSUMPTION LOWERING	33 l/sec
WORKING PRESSURE	6 Bar
AIR CONNECTION	1/2" BSP
MINIMUM HOSE DIA.	1/2"
WEIGHT 3M HOL	23.5 kg
ADDITIONAL METRE HOL	1.6 kg

T: +44 (0) 1651 872101
sales@redroosterlifting.com