









2D et 3D Crystal Engravings





Gravure 2D 3D

Cube / Cut corner cube

	A	60 x 40 x 40 mm	39 euros
	A1	80 x 50 x 50 mm	59 euros
	B	90 x 60 x 60 mm	69 euros
	D	100 x 60 x 60 mm	89 euros
	key ring / porte clé		19 euros
	key ring / porte clé gravé 3D		29 euros

Cube / cube à plan coupé.

	D	110 x 75 x 65 mm	119 euros
	E	130 x 100 x 90 mm	149 euros
	F	200 x 150 x 100 mm	259 euros

	G	40 x 40 x 40 mm	39 euros
	G1	50 x 50 x 50 mm	49 euros
	H	60 x 60 x 60 mm	69 euros
	I	80 x 80 x 80 mm	89 euros
	J	100 x 100 x 100 mm	159 euros

Coeur / Heart

	100 x 90 x 60 mm	89 euros
	90 x 90 x 60 mm 80 x 65 x 35 mm	79 euros 69 euros

Médaille / Médal

	Médaille	19 euros
--	----------	----------



Flat

	180 x 130 x 8 mm	59 euros
	190 x 150 x 10 mm	69 euros



Verre plat

	130 x 90 x 8 mm	49 euros
---	-----------------	----------

Support

	pour A, B et C	14 euros
	pour B et C	18 euros

Socle

	pour A, B et C	15 euros
	pour D et E	25 euros
	pour F	89 euros

Reglette lumineuse

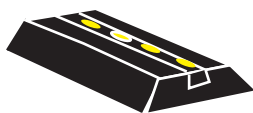

2 tailles	petite	22 euros
	grande	24 euros
	pieds pour reglette 8mm	8 euros
	pieds pour reglette 10 mm	10 euros

	adaptateur	5 euros
---	------------	---------

2D to 3D conversion @ 10 euros per Face.
2D à 3D, la conversion coute 10 euros par sujet.
frais de modélisation suivant travail.

textes 5 euros the line - 5 euros la ligne

Autre format ou demande de modelisation:
commande et réalisation suivant devis

Ci après nos coordonnées et adresses: