

ASIN AQUA[®] Home VS

EN

2021

CUTTING EDGE TECHNOLOGY
FOR CRYSTAL CLEAR AND HEALTHY POOL WATER



INTEGRATED
VS PUMP
CONTROL



General safety information

This user manual contains basic information that should be observed during assembly, start-up, operation, and maintenance. Therefore, this user manual must be read by installers and operators prior to assembly and start-up, and must be accessible to every user of this unit. Additionally, all further safety information in this document absolutely must be observed. Read and follow all instructions. In order to minimize the danger of injury, do not allow children to use this product. Hazards from non-compliance with safety information. Non-compliance with safety information can result in hazards to persons, the environment, and the equipment. Non-compliance with safety information will result in a forfeit of any potential right to damage compensation.

Insufficient personnel qualification

Hazards in the event of insufficiently qualified personnel, potential consequence: Injury, heavy material damage.

- The system operator must ensure compliance with the required qualification level.
- Any and all work may only be performed by correspondingly qualified personnel.
- Access to the system must be prevented for insufficiently qualified persons, e.g. via access codes and passwords.

Potential overdosing of chemical agents

Despite ASIN Aqua® comprehensive safety functions, it is possible that a probe failure and other errors could lead to an overdosing of chemical agents. Potential consequence: Injury, heavy material damage.

- Design your installation such that uncontrolled dosage is not possible in the event of a probe failure or other errors, and/or such that uncontrolled dosage is recognized and halted before damage is incurred.
- Uncontrolled overdose of chemicals can cause harm to health and property. Even though the device contains a number of security elements can not be ruled out that in case of failure of the measuring probes, or the whole device may result in overdose of chemical agents. Install the equipment so that uncontrolled overdose of chemicals was not possible and that uncontrolled overdose has been detected in time before causing any harm. It is necessary to use chemicals in such quantities that an overdose will not cause dangerous concentration of chemical agents. Do not use chemicals in too large packages or with too high concentration.

Gaseous chlorine produced from dosing in standing water if dosing outputs are not closed via the filter pump

If the flow switch is stuck or experiences another error, there is a risk of dosing into standing water. Poisonous chlorine gas can be yielded when sodium hypochlorite and pH minus come together.

Non compliance with informational text

There is a great deal of informational text indicating hazards and their avoidance. Not observing informational text may lead to hazards. Potential consequence: gravest degree of injury, heavy material damage.

- Read all informational text carefully.
- Cancel the process if you are unable to exclude all potential hazards.

Use of new functions

Because of the continued development, a ASIN Aqua® unit may contain functions, which are not completely described in this version of the user manual. The use of such new or extended functions without a profound and secure understanding by the operator may result in malfunctions and severe problems. Potential consequence: Injury, heavy material damage.

- Make sure to get a profound and secure understanding of a function and relevant boundary conditions, before you start to use it.
- Check for an updated version of the user manual or additional documentation available for the relevant functions.
- Make use of the integrated help function of the ASIN Aqua® to get detailed information on functions and their parameter settings.
- In case it should not be possible to get a profound and secure understanding of a function based on the available documentation, do not use this function.

Overdosing if pH value is wrong

If disinfection is enabled before the pH value is stable in the ideal range of 7.0 to 7.4, then it may lead to heavy overdosing of chlorine or bromine. Potential consequence: Injury, heavy material damage.

- Do not start disinfection with chlorine until the pH value is stable in the ideal range between 7.0 and 7.4.

Conditions before using

Make sure you have a newest and updated version of the user manual and other documentation for all functions of the unit. Use and read the integrated help features. In case of not understanding the information about certain features of the unit, do not use these features.

Handling chemicals for pool water treatment

The chemicals used with the ASIN Aqua must be handled in a safe manner to prevent damage or personal harm. Aseko recommends you always use personal protective safety equipment when handling the pH and chlorine agents. Refer to the Materials Safety Data Sheet (MSDS).

WARNING: Never mix the pH agent with the chlorine agent. When carrying out maintenance on the clear plastic tubes or valves always rinse with clean water to prevent mixing of the pH and chlorine agents.



What do you receive in your box

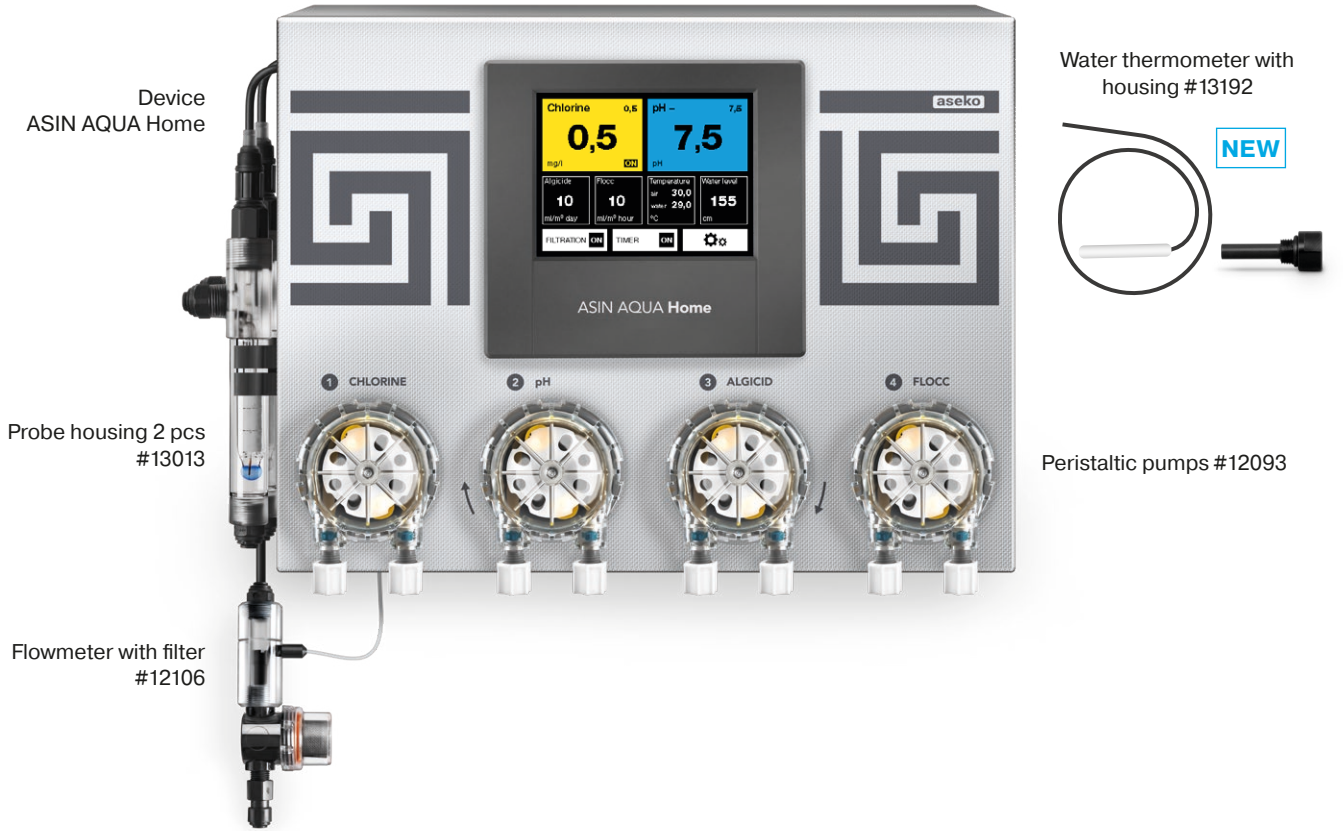

Long Life pH Probe #12012



CLF* probe #12052



or

Redox Long Life* probe #12016



Water valves 2 pcs #12006



Injection valve 4 pcs #12005



Suction tube weight 4 pcs #12023



PE Tube 1/4" (6.35 mm) transparent 15m #12008



Wrench socket for probes #13046



Dowels and screws



Available optional accessories

External touch display
#12048



Pressure-type level sensor
#12086



Coagulation mixer
#30001



Inserting DN50 plug
1/4" threaded #12134



Photometer
13076



pH 7.00 Buffer #12065 Redox
Buffer #12063



Air thermometer
#13192

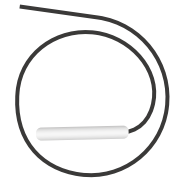

ASEKO original chemical solution

20 l volume for pools

CHLORPURE #12075



pH MINUS #12130



ALGICID #12156



FLOC+C #12139



5 l volume for whirlpools

CHLORPURE #12059



pH MINUS #12131



ALGICID #12157



FLOC+C #12138



ASIN AQUA Home



MAX POOL VOLUME
250 m³

Congratulations to purchase Smart pool management system ASIN AQUA Home.

With ASIN AQUA Home you are getting the top-class high precision pool water management system. By combination of traditional, for years approved, disinfection technology, precise measuring, by FREE Chlorine Membrane Probe, with digital intelligence and connection to ASEKO Web Services becomes the ASIN AQUA Home the best solution for Your pool. Chlorine disinfection with precise pH management, boosted by dosing of Algicide and Flocculating aid assure the crystal-clear water of your pool by use of the lowest necessary amount of chemical aids. User friendly Smart control functions of ASIN AQUA Home will make your pool fully automatic and the pool maintenance become just fun. Online connection to ASEKO Web Services system and smart application iPool Live will give you the pool status overview from where ever you are connected to internet.

Pool water treatment

Well-balanced combination of all treatment aids will provide clean and crystal clear water

Chlorine control and dosing

Highly effective disinfection treatment of pool water for public and private pools. Extraordinary precise measuring of chlorine content in the pool water by ASEKO CLF - free chlorine probe combined with the system digital intelligence is able to control the preset disinfection level by usage of minimum necessary chemical aids.

pH control and dosing

ASIN AQUA Home is adjustable to dose **pH MINUS** or **pH PLUS**. Treatment for stabilizing of pool water acidity at the optimum level. Precise measuring by pH probe combined with the system digital intelligence controls the preset pH level of the circulating pool water in all pool operation modes and variable environment conditions.

Algicide daily dosing

Dosing of preset daily effective portion of biocide (based on the pool volume) that protects your pool against algae, fungi, moulds and bacteria.

Flocculant+Coagulant time continuous dosing

Effect of bright and crystal clear water managed by slow continuous dosing of flocculation and coagulation aids that improves the capability of filtering even the smallest invisible water impurities that are in standard conditions able to pass through the filter.



Pool management functions

Filtration Time Control

Daily, automatic start of the filtering for individually preset periods.

Water Level - Refilling

Water level can be monitored by optional **level sensor**. System can be individually programmed to control up to four different water levels at your pool and switch the water refilling or waste water draining on/off (this requires an optional **Besgo** valve for automatic backwashing).

Filter Backwashing

The system can control the filter backwashing time interval (this requires an optional **Besgo** valve for automatic backwashing).

Smart Heating Control

The system is equipped by intelligent control of preset water temperature. It can switch and control the heating (electrical heating, gas heating, heat exchanger) by logic of integrated smart heating functions. The system must be equipped by optional **air thermometer**.

Freeze Protection

Unless you want to drain the pool for the winter season, this function can ensure protection of the pool water against freezing. The system must be equipped by optional **air thermometer**.

Control by External touch display

Some functions of ASIN AQUA Home can be monitored and controlled by external touch display. System must be equipped by optional **External touch display**.

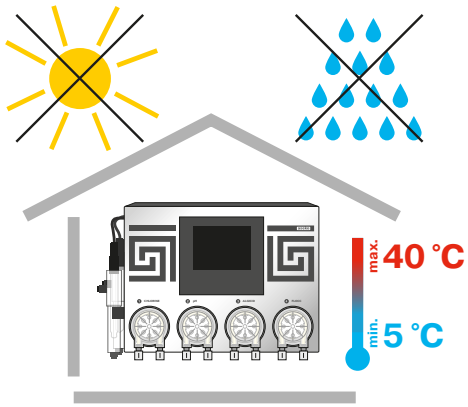

ASIN AQUA Home Installation

ASIN AQUA Home is to be wall mounted in dry and dust-free environment with temperature ranging from +5 °C to +40 °C. Install the mounting rail, which serves for attachment, to the wall. Select location so that free space at least 40 cm in all directions and height above floor at most 150 cm are provided. Drill three holes in the wall at the distance of 18.5 cm. Use screws supplied with ASIN AQUA Home for attachment.

WARNING: The location temperature should permanently be in the range from +5 °C to +40 °C.

Direct sunlight, high humidity and dust may lead to damage to ASIN AQUA Home.

- Before installing, ensure that pool water is chemically clean and free of dirt.
- The maximum distance of injection valves from peristaltic pumps of ASIN AQUA Home must not be greater than 8 m.
- Vertical distance between ASIN AQUA Home and the bottom of containers must not exceed 2 m.

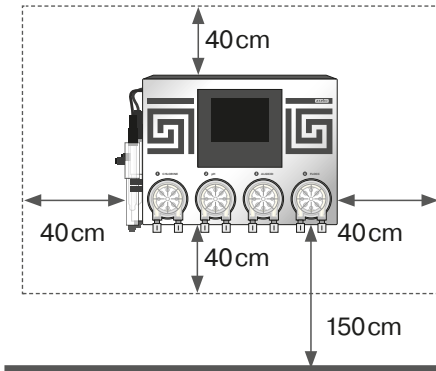

Wall bracket

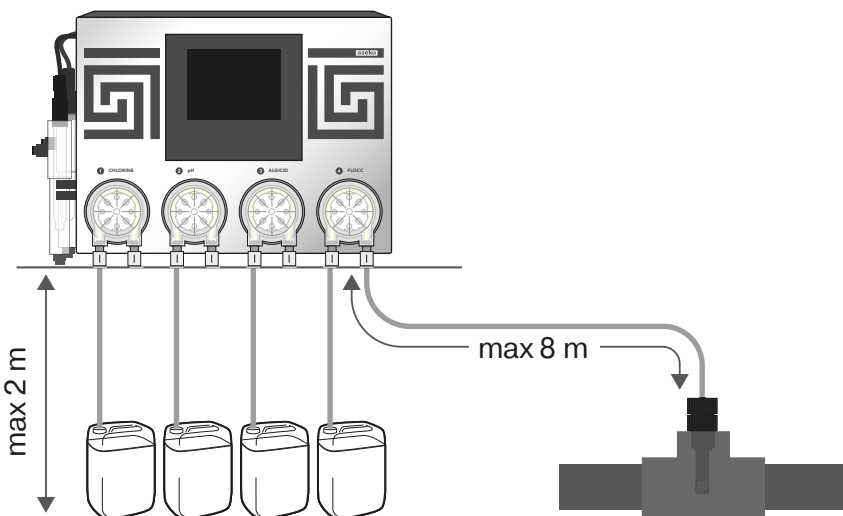
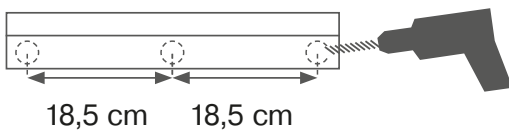

Installing the Probes

1. Carefully insert the pH, CLF or REDOX probe into the housing.
2. Hand tighten or use the attached plastic wrench socket for probes.
3. Connect the connector and lock it by tightening a connector ring.

After probes have been inserted, slightly tightened and connectors have been connected, ASIN AQUA Home is ready for connection to the water system of your pool.

WARNING: Only hand tighten the probes or use the attached plastic wrench socket for probes. Do not use pliers or steel wrench.

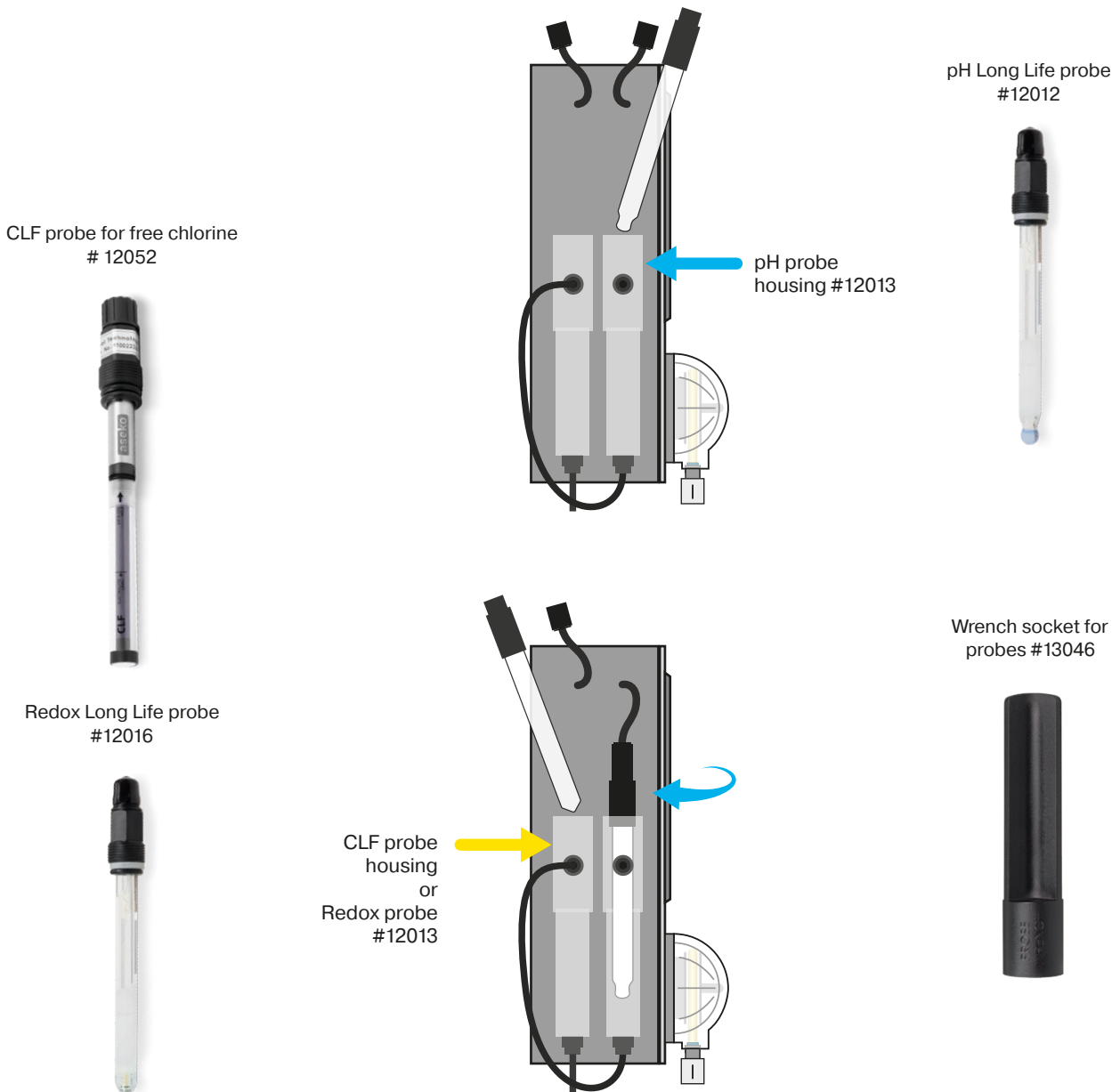

Pool Water Connection

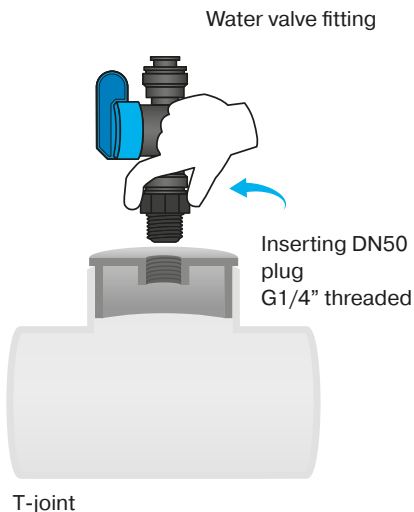
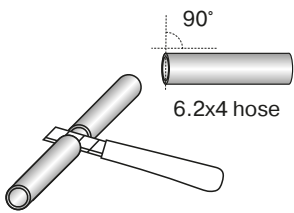
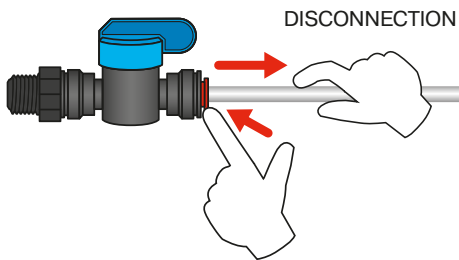
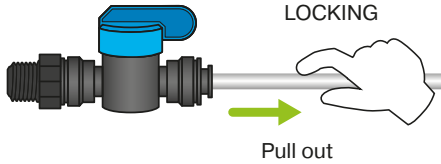
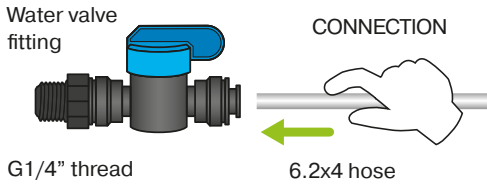

The pool water to be measured must be connected to ASIN AQUA Home. Connect the measured water inlet downstream of the pump, upstream of the filter and ZPM (coagulation mixer).

Place the water valve fitting to the T-joint, blinded by DN50 G1/4" threaded plug #12134.

- The connecting fitting is installed in G1/4" thread.

Aseko provides the unique Speedfit connecting fitting for measured water connection to your ASIN AQUA Home. To connect the interconnecting tube, push it into the Speedfit connector and then lock it by pulling back. To disconnect the interconnecting tube, push and hold a circular collet and pull the interconnecting tube out.

WARNING: To treat PE tube ends, use a sharp knife (part of delivery). The use of scissors or tongs deforms the tube end and leads to leaks.

WARNING: Only hand tighten. Do not use tongs or any other tools.

1. To ensure tightness of joints, cut the tube at 90 ° angle.
 - Use the sharp knife to cut plastic. The cut must be clean and smooth.
2. Connect the water inlet to the measured water filter connection and the water outlet to the probe housing connection. Make sure that measured water pressure does not exceed 1.5 bar.
3. The water outlet can be realized:
 1. downstream of filtration
 2. to non-pressure (overflow tank)
 3. upstream of filter pump

After the water inlet has been connected and opened, your ASIN AQUA Home is ready to measure and adjust the pH and Cl value in your pool so as to achieve the required values.

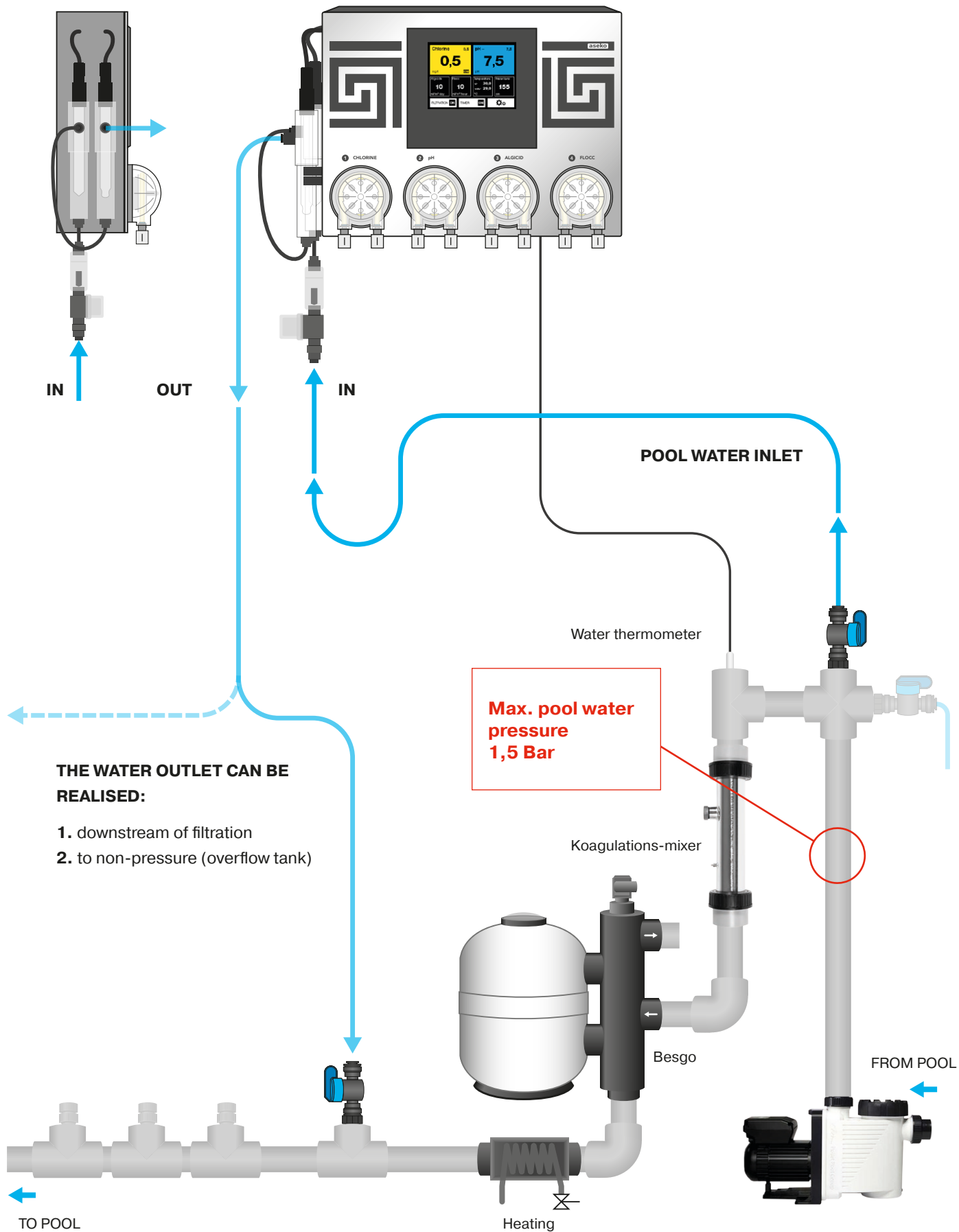

Pool Chemicals Connection

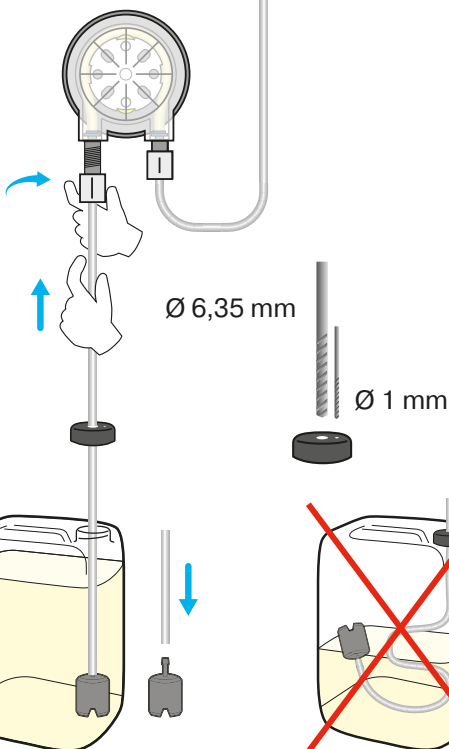
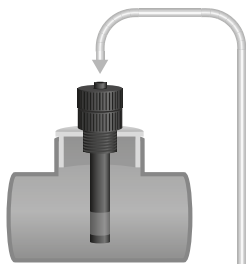
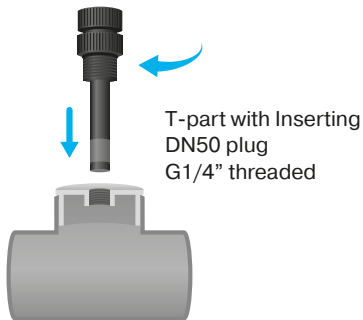
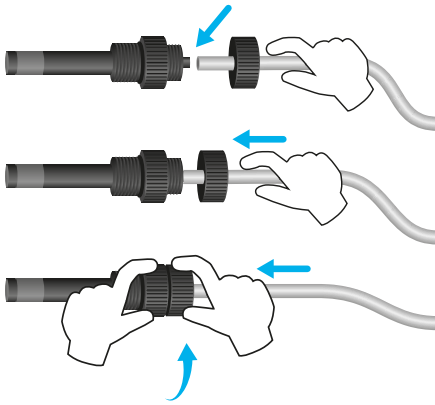

At this step is necessary to connect the injecting valves of individual chemicals to the dosing pumps and dosed agents.

Place the injecting valve in the T-joint, blinded with the DN50 G1/4" threaded plug #12134.

1. Cut the PE tube at 90 ° angle to ensure proper fitting.
 - Use the sharp knife to cut plastic. The cut must be clean and smooth.
2. Drill the 6 mm hole and the 1 mm hole (air suction) into the CHLORPURE canister cap. Push the PE tube through the cap. Select the tube distance so that the tube reaches the canister bottom and can be connected to the pump as straight as possible. A long tube in the canister would bend and produce air bubbles.
3. Put a weight on the tube end and dive it in the canister.
4. Connect the plastic tube from the CHLORPURE canister to the ASIN AQUA Home pump (marked as 1 CHLORINE) to the left connection.
5. Connect the plastic tube to the 1 CHLORINE pump right connection and the injection valve.
6. Hand screw the CHLORPURE injection valve in the specified mounting hole (see diagram).
 - The injection valve is installed in G 1/4" thread.

To connect dosing of pH, algacide and flocculant, repeat steps 1 to 6 for other pumps according to their marking.

- Check throughput of the injection valves and tightness of the entire system (see installation test).

WARNING: Only hand tighten. Do not use tongs or any other tools.

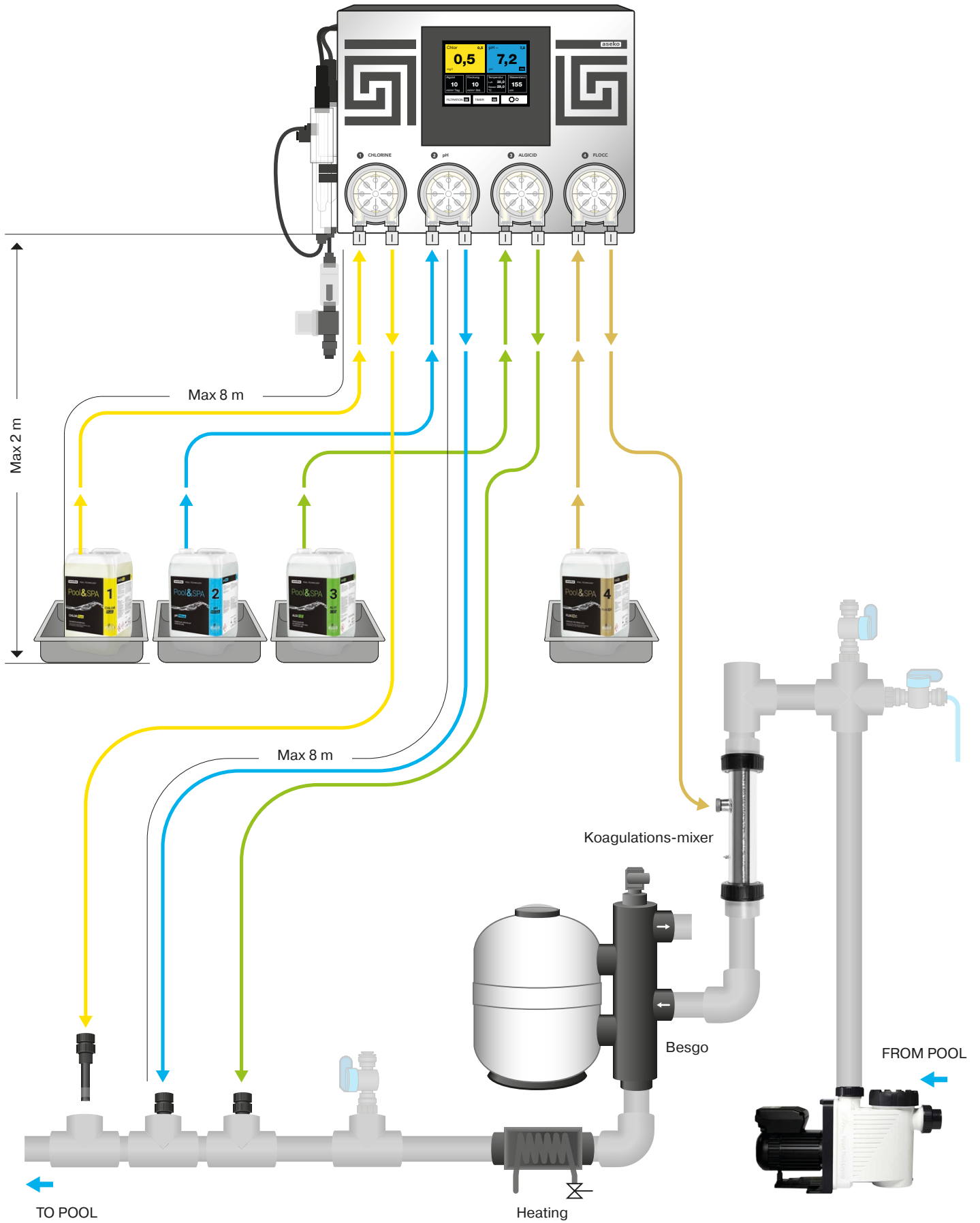

Accessories Connection

POWER SUPPLY

230 V ~ 50 Hz

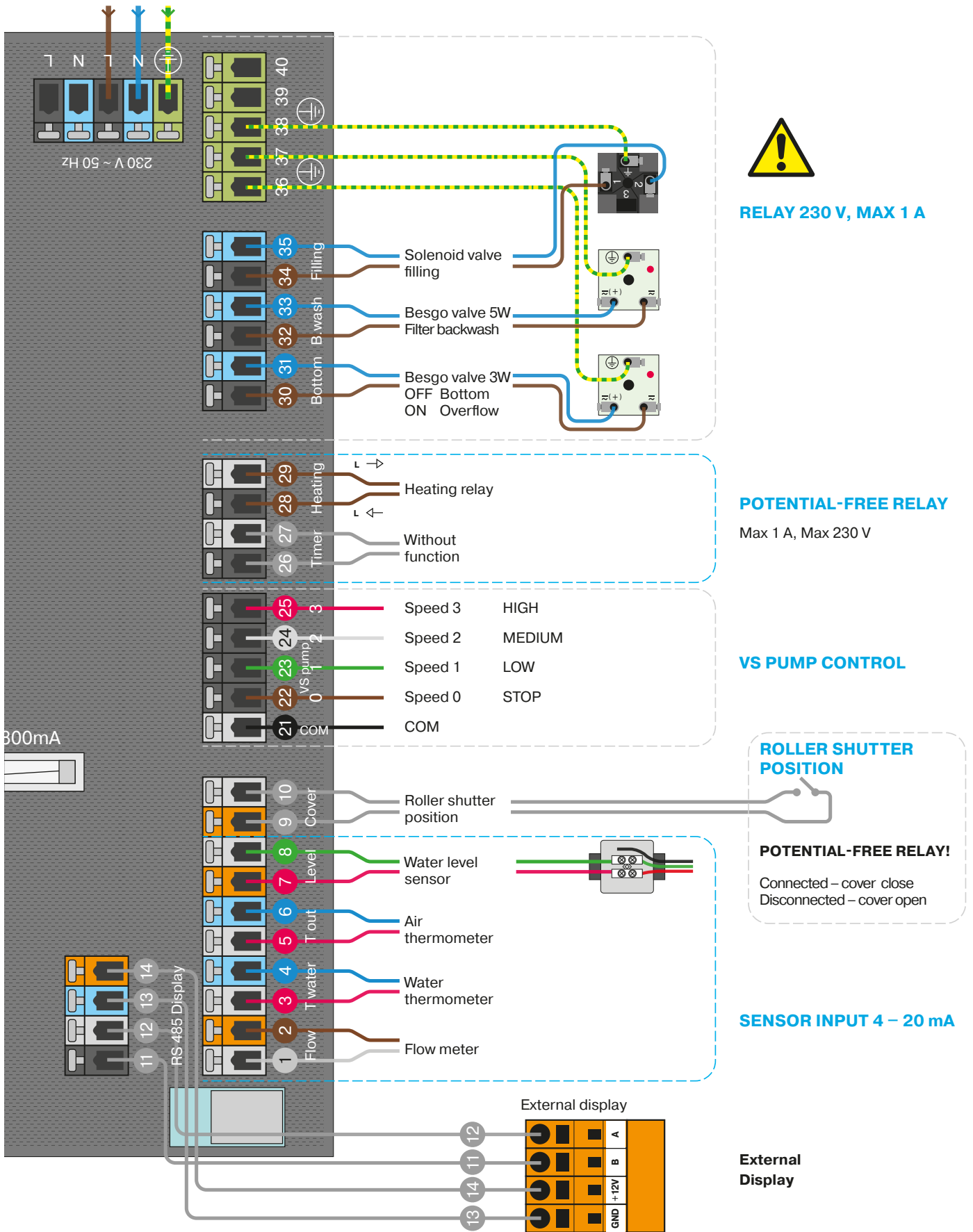

VS Pump module connection

SPECK

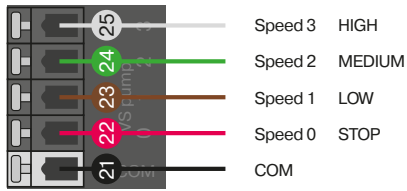

TYP A

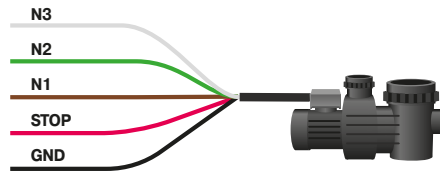

PENTAIR

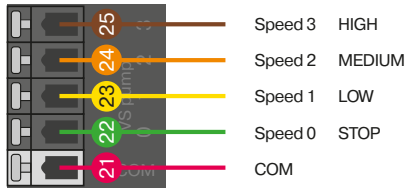

TYP B

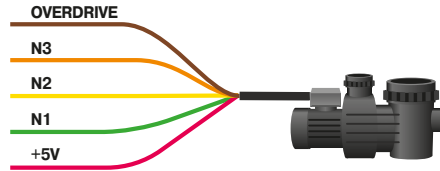

HAYWARD (older type)

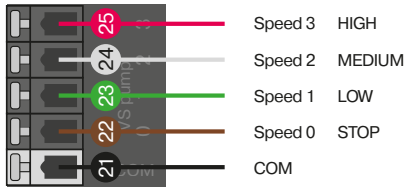

TYP C

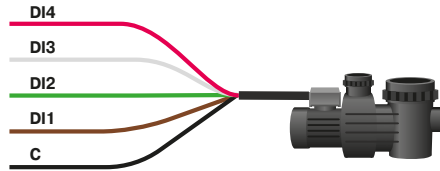

DAB E.SWIM - E.PRO

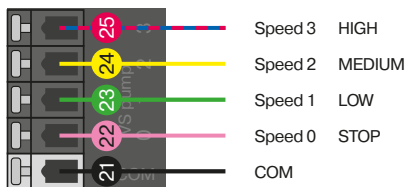

TYP B

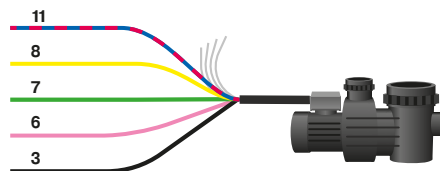

UWE EO PM

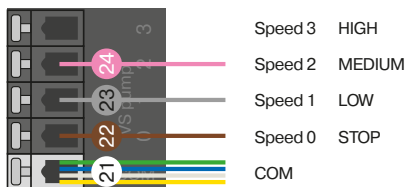

TYP A

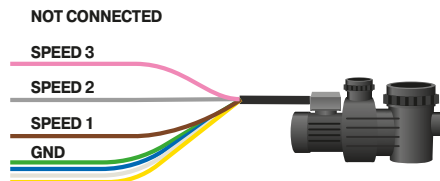

INVERTER POOL PUMP

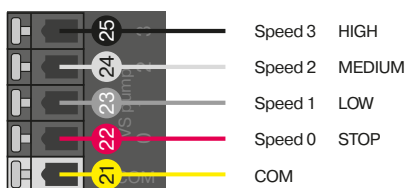

TYP A

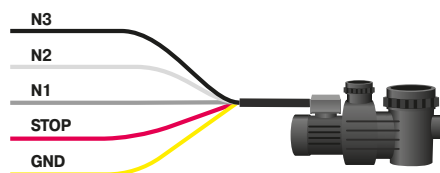



Installation must be protected by a residual current device (RCD).

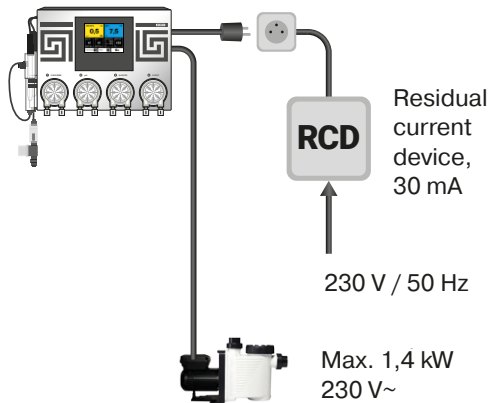

Power Supply

Connection to the mains:

1. Leave the mains switch in the off position.
2. Connect the filtering device to the ASIN AQUA Home switched socket outlet (filtration power supply - max. 1.4 kW / 230 VAC).
3. Connect the 230 V / 50 Hz mains cable to ASIN AQUA Home (on the right side). The mains socket outlet must be protected by a residual current device (RCD).
4. Change the mains switch over to the on position.

After Device has been switched on, the display will come on and the ASIN AQUA Home starting screen will appear.

Disconnection from the mains:

1. Change the mains switch over to the off position.
2. Disconnect the ASIN AQUA Home mains cable from the 230 V / 50 Hz socket outlet.
3. Disconnect the filtering unit mains cable from ASIN AQUA Home.

WARNING: If Device is used in the manner different from that specified by the manufacturer, protection provided by Device may get damaged.

Power supply	230 V / 50 Hz
Power consumption	24 VA
Power consumption (including filter pump)	1449 VA
Maximum input power of connected filtration	1.4 kW / 230 VAC
Fuse	T800 mA; T160 mA; T6,3 A
Over-voltage category	II
Ingress protection	IP30
Operating temperature	+5 to +40°C
Weight	6.7 kg
Installation	wall mounted
Relay output contacts	230 V / 1,4 kW
Discharge of dosing pumps	60 ml / min / max. 1bar
Measured water pressure	max. 1 bar (no underpressure required)
Dimensions	430 x 330 x 160 mm

ASIN AQUA Home Installation Test

WARNING: Any obstacles, bubbles or leaks in the connecting tube will prevent ASIN AQUA Home from correct operating. The clear plastic tube allows you to monitor flow of liquid to the injecting valves.

Before commencing the operation, test ASIN AQUA Home installation. Most problems result from incorrectly performed installation.

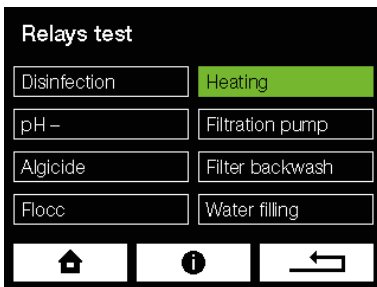

Test

In the “Test of Outputs” menu, gradually start all the pumps and while they are running, check tightness of all the PE tube connections. Check the injecting valves for blockage and air bubbles in the PE tube.

DO NOT FORGET! Provide the testing run and stop of all accessories connected to ASIN AQUA Home. At this step just test, do not dose the aids or provide the initial dose of chemicals!

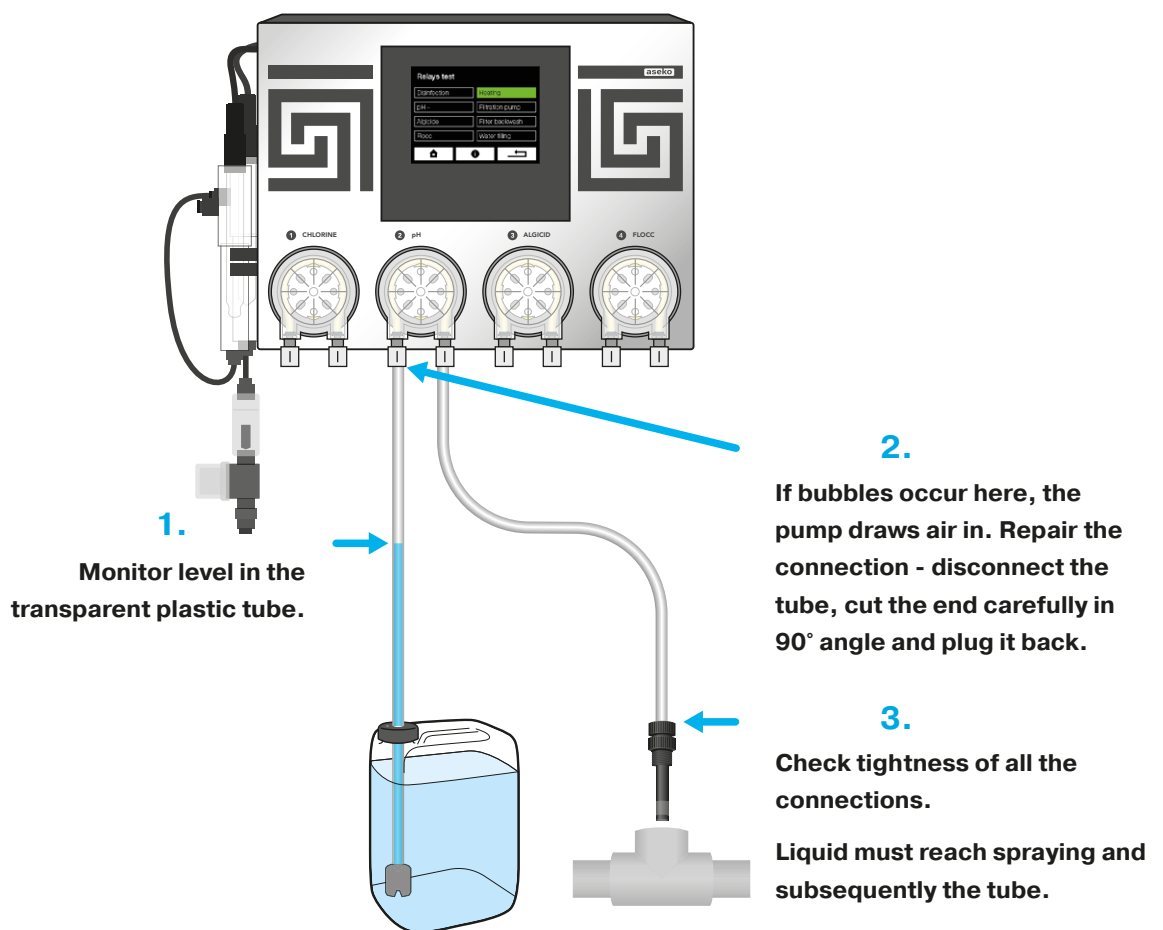

Touch screen description

Basic Screen

The basic screen display measured, required values and status information.

E.g. click on the **Chlorine** tab to enter the setting of the required chlorine value in pool water.

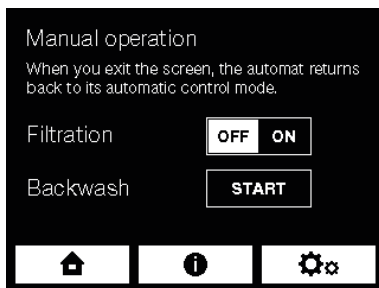
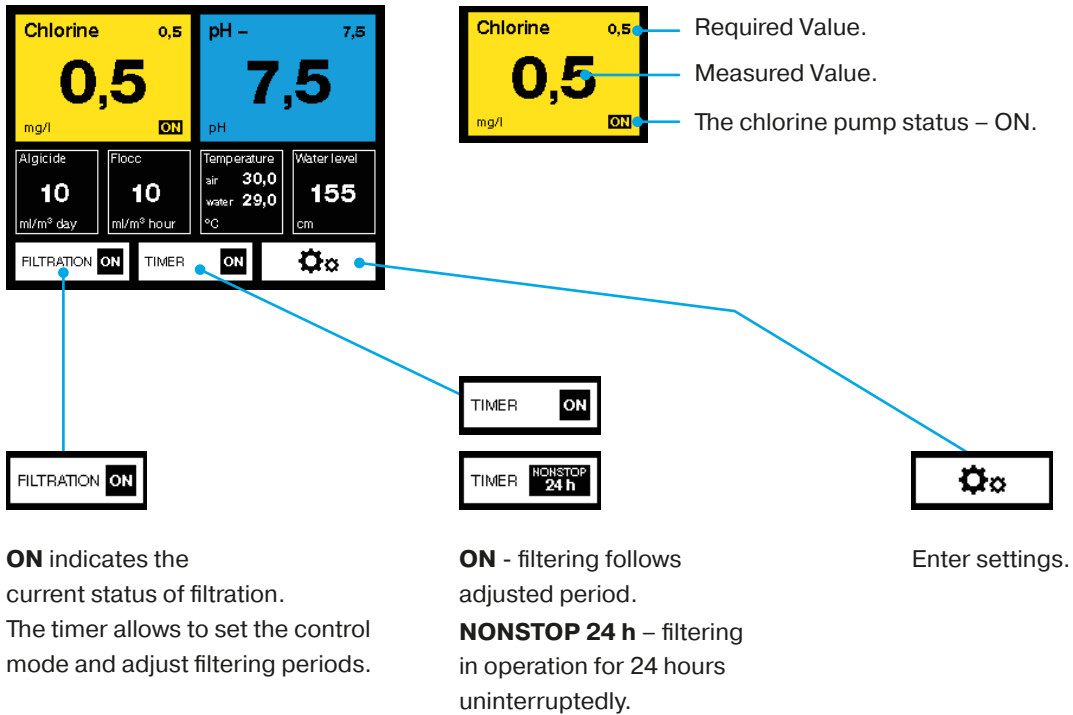

Manual control allows to:

- switch filtration on/off** independently to preset filtering periods.
- start filter washing** independently to adjusted washing time.

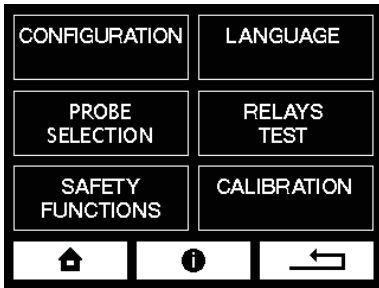

Settings



Back to the main screen.



Displays help/manual for the particular screen.



Back to the previous screen.

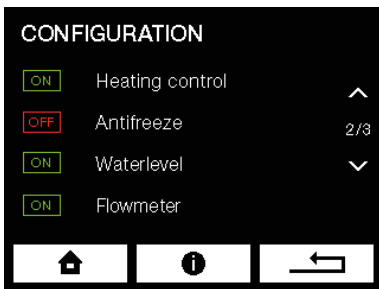

Movement through Menu



Movement in menu to the previous page.

Indicator of the current page and the total number of pages.

Movement in menu to the next page.



ON - function is switched on



OFF - function is switched off

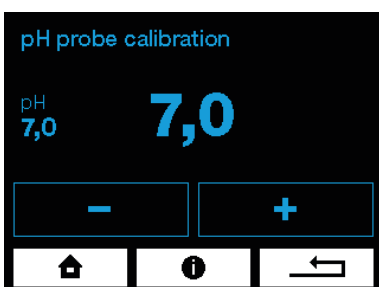

Value Settings



Reduces the value.



Increases the value.

Configuration

Date and Time

To ensure the correct function of timers, set the current date and time.

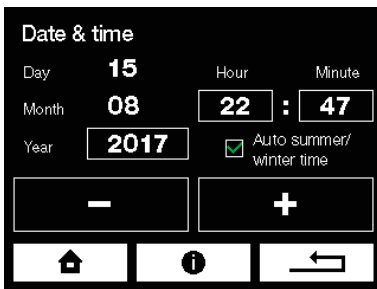

Pool Volume

To ensure the correct function of ASIN AQUA Home, enter the correct volume of your pool. Calculate your pool volume in m³:

Length (L) times width (W) times depth (D) is volume (V) - (L × W × D = V).

Enter the value using + and - buttons.

WARNING: The pool volume has effect on the maximum safe dose, enter the correct value.

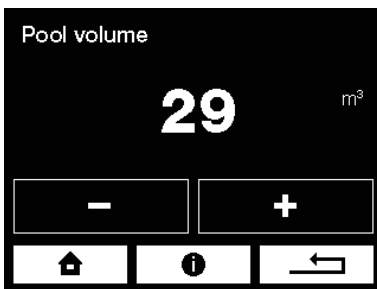

Filtration Timer

Filtration can be set to NONSTOP operation for 24 hours or to one, maximum to two time periods.

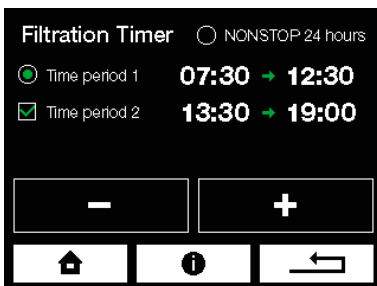

Variable Pump Control

ASIN AQUA Home allows to control the SPECK or PENTAIR variable output circulating pumps. The pump runs at speed 2 in filtering periods, besides the preset filtering (when the standard pump is off) it runs at speed 1 (or can stay switched off according to your choice). In case of backwashing, the pump is running at speed 3.

Individual speeds 1, 2, 3 are adjusted directly on the pump according to the respective pump manual.

Automatic Filter Washing

Considering that the ASIN AQUA Home technology is in particular based on the high efficiency of filtering and removing even the finest impurities, it is necessary to **wash the filter on a regular basis**. The automatic washing function ensures the filter washing on a regular basis in the preselected intervals.

To enable this function, it is necessary to use the automatic 5-way BESGO valve. Its moving is enabled by the relay switching on. When the relay switches on, the BESGO valve is enabled and moved to the required position by the action of pressure water or air. See the BESGO manual.

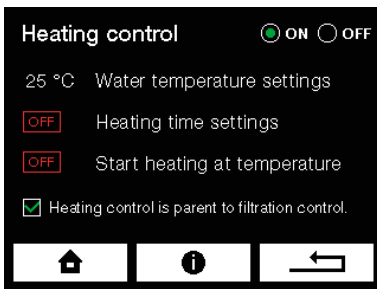

Heating Control

Water Temperature Measurement and Heating Control

The high-accuracy electronic thermometer is used to measure water temperature. This should be installed to the inlet pipe coming from the pool. Never mount it downstream of the heat exchanger. Significant distortion of temperature occurs. When temperature drops below the required value, the relay switches on your heat source (heat pump, electric heating, gas boiler circulating pump).

Smart Heating

Heating Control Function Takes Priority over Filtration Control

If you select the temperature control to take priority over the filtration timer, heating as well as the circulating pump will be in operation even after the adjusted filtering time has elapsed. The pump will stop only after the required temperature has been achieved.

Heating Time Adjustment

This function allows to adjust day time for which heating will be in operation. This is particularly useful for switching on the heat pumps that have a higher efficiency during the day when outdoor temperature is higher, eventually to eliminate the time when noise from heat pump disturbs you neighbor.

Heating at Outdoor Temperature (above or below)

This function allows to adjust outdoor air temperature at which or below which ASIN AQUA Home starts heating. This function requires installation of the **outdoor air thermometer**. This function is useful to control effectiveness of air heat pumps eventually to eliminate heating when you do not use the pool.

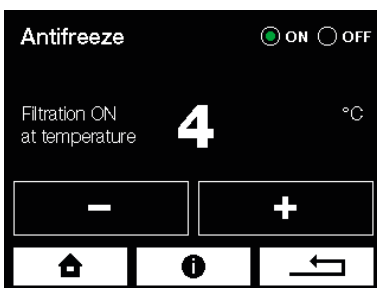

Freeze Protection

To enable the function, it is necessary to install **outdoor air thermometer**.

- After the freeze protection has been enabled, ASIN AQUA Home checks outdoor temperature. If outdoor temperature is lower than 0 °C, filtration is switched on to circulate the pool water. After 15 minutes will ASIN AQUA Home measure temperature of the pool water.
- If the pool water temperature drops below the value set in the freeze protection menu (4°C), ASIN AQUA Home will continue filtering and switch on the pool water heating. After the required freeze protection temperature has been reached, heating and filtering will stop.
- If outdoor temperature stay below zero, filtering will start in 6 hours again for 15 minutes in order to control water temperature.

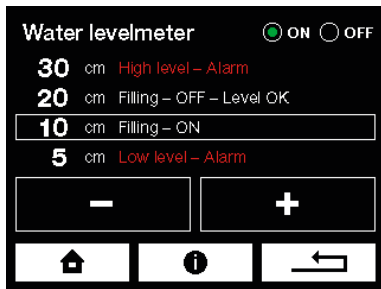

Level sensor - Level Monitoring and Automatic Refilling

Level measurement is performed by the **pressure-type level sensor**. This allows the very easy installation of the sensor by its inserting into the storage water reservoir or skimmer. Level is monitored at four heights that are easily entered in centimeters of water height.

Setting:

High level ALARM - too much water in overflow tank

After this level is reached, following actions may start:

1. If the automatic filter washing is enabled, one filter washing cycle starts and drains the waste water.
2. If the automatic filter washing is not enabled, the relay 19 switches on (filter washing) for the period of time until level is OK. The second circulating pump or automatic drain valve can be connected to this relay.

Refilling OFF - required level

Refilling stops

Refilling ON - level at which refilling starts

Refilling starts after if the water level stay permanently at least for 10 seconds below this value (in order to prevent oscillating)

Low level ALARM

Circulation (filtering) pump shuts off

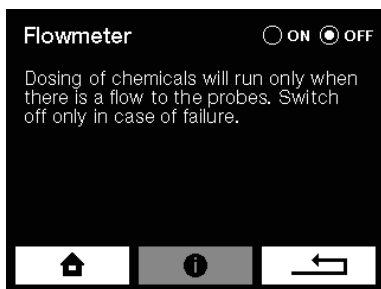
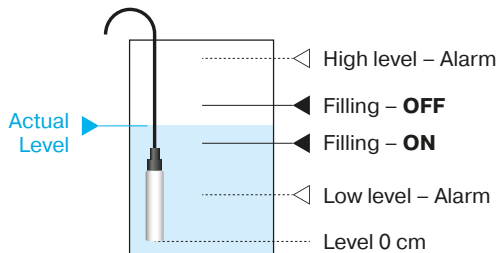

Flowmeter

The flowmeter detects flow of measured water. Dosing of chemicals will take action only if flow of measured water to probes is detected.

Wash the check flowmeter strainer on a regular basis.

Warning: Only switch off the flowmeter in case of a failure.

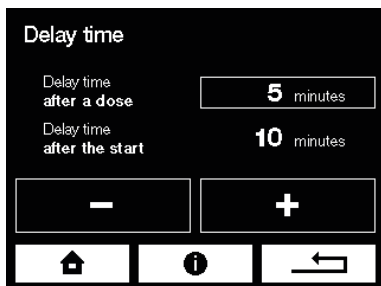

Delay

Delay time after dose is time for which ASIN AQUA Home does not dose and wait for the dose response at the measuring water. At pools is average response time 4 to 10 min, at SPA 1 to 10 min.

Delay time after start (upon timer switching on) is time after start for which ASIN AQUA Home does not take any action and it waits for stabilization of a signal from probes.

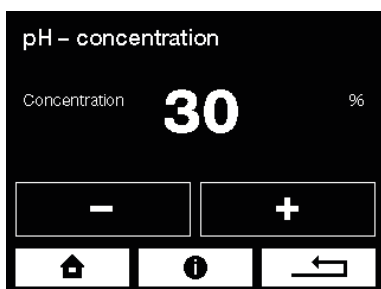

Concentration pH -

If you use the original ASEKO Pool & SPA chemicals keep the preadjusted values. In case of use other non-original chemicals adjust concentration according to data on the label of a chemical used.

Recommendation: Use the original ASEKO Pool & SPA chemicals

Warning: Higher concentrations of chemicals can result in shorter lifetime of ASIN AQUA Home components and may cause injury and health damage.

Choosing the disinfection probe

1. CLF free chlorine probe

Free chlorine measurement, CHLOR PURE dosing



2. Redox probe of the RX potential

Measurement of redox potential, CHLOR PURE dosing



3. DOSE ml/m³ time dose per hour or per day

Without a probe, CHLOR PURE time dosing

No need of probe

It is recommended to use this function only as “EMERGENCY MODE” in case of probe failure.

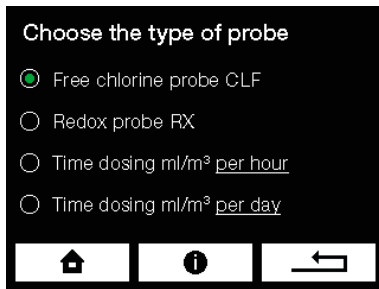

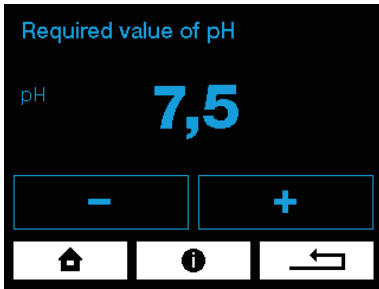

pH Setting

Considering that the ASIN AQUA Home water treatment system is efficient in the broad pH range, it is useful to enter the required pH value equal to pH value of water you refill or slightly lower.

Required pH value = refilled water pH value (in the range from 6.8 to 7.5)

pH may change during operation but if it is in the range from 6.8 to 7.5 you do not have to change this setting.

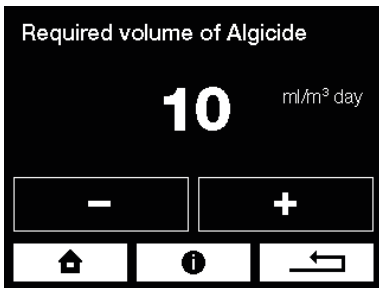

ALGICIDE Setting

A sufficiently effective dose for most pools is 10 ml/m³ per day. If green algae appear in the pool, you can increase the dose. After algae have disappeared, the dose can be returned to 10 ml.

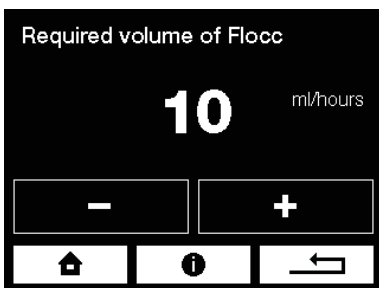

FLOC+C Setting

The FLOC + C dose is governed by the amount of circulating water, which flows through the filtration.

Based on your circulating pump discharge (in m³ per hour), adjust the FLOC+C dose value. This value ranges from 10 to 40 ml per hour for most domestic pools.

Setting Values

Commissioning procedure

The water in the pool must be clean without any additives. Ideally fill the pool with fresh water from the water main.

1. Ensure the filtration system runs **NONSTOP** for 24 hours

- Set the required values via the main screen by pressing the appropriate tab (see the chapter Control):
- If you have the CLF probe, set the disinfection to 0.0 mg/l.
If you have the REDOX probe, set the disinfection to 000 mV.
- pH values leave at the factory setting for the time being (pH 7.0).
- Set ALGICID to 10 ml m³ per day (see the chapter ALGICID Setting).
- Set FLOC+C to 10 ml m³ per day (see the chapter FLOC+C Setting).

2. Close the water supply to the probes

ASIN AQUA Home display "No water supply to the probes" notification.

3. Perform superchlorination

Perform superchlorination of pool water with Super CHLOR (inorganic active chlorine without stabilizers).

Follow the instructions on the packaging (1 kg = 80 m³).



Wait at least 1 hour. Optimally up to 24 hours.

SuperCHLOR
#13120



Before opening the water supply to the probes, the water must be **clean** and the **chlorine concentration** measured by the colorimeter or Pool Tester must be within the range **0.3 to 1.2 mg/l**.

If the **concentration is lower**, repeat superchlorination. If the **concentration is higher**, wait till the chlorine concentration in the water drop down.

4. Open the water supply to the probes

the "No water supply to the probes" notification will disappear from the ASIN AQUA Home display.

5. pH adjustment

- Set the **required pH value** ideally close to the pH value of the incoming water.
- **ASIN AQUA Home adjusts the pH automatically according to the preset required value.**
- **The ideal pH value** should be between **6.8 and 7.5**.

6. Depending on the type of a probe you have, proceed according to the chapter:

- If you have the CLF probe
- If you have the REDOX probe

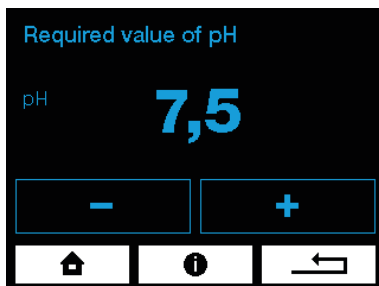

If you use the CLF probe

For the correct functionality of the CLF probe you must observe the following conditions:

pH of the pool water

The ideal pH value should be between **6.8 and 7.5**.

The pH of the pool water must be stabilized.

If the pH value fluctuates, the value of the chlorine in pool water changes accordingly.

Chlorine content mg/l	Water temperature
0.3 to 0.5	24 to 26 °C
0.5 to 0.8	26 to 32 °C
0.8 to 1	Over 32 °C

Determination of the required chlorine value in pool water

The required concentration of chlorine in pool water varies with the temperature of the pool water. However it should never be less than 0.3 mg/l. Determine the required value using the table located on the left.

How to set the required chlorine value

Use a colorimeter or Pool Tester to measure the chlorine value in pool water sample.

If the chlorine concentration (measured with a colorimeter or Pool Tester) is:

- **ADEQUATE** to the value shown on the ASIN AQUA Home display, your device is ready to maintain the required concentration of chlorine in pool water.
- **BELOW** the required value shown on the ASIN AQUA Home display, **increase** the required value over the current setting **by 0.1 (by 0.2 mg/l max)** (regardless of the required value according to the table).

Repeat the measurement after the water in the pool is mixed thoroughly and the required value shown on the ASIN AQUA Home display is settled. Repeat the process until the **chlorine concentration in pool water matches the required value** then set the correct required value according to the table. Subsequently you can calibrate the CLF probe (see the chapter CLF Probe Calibration).

- **HIGHER** than the required value shown on the ASIN AQUA Home display - you can calibrate the CLF probe (see the chapter CLF Probe Calibration).

NOTIFICATION:

Fix the **low chlorine value** in pool water by **increasing required disinfection value**.

RECOMMENDATION: Check the chlorine content in the pool once a week using the colorimeter or tester.

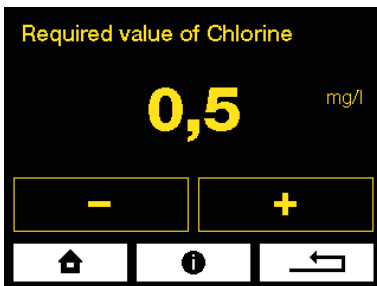

If you use the Redox probe

For the correct functionality of the REDOX probe, you must observe the following conditions:

pH of the pool water

The ideal pH value should be between **6.8 and 7.5**.

The pH of the pool water must be stabilized.

If the pH value fluctuates, the value of the Redox changes accordingly.

Determination of the required chlorine value in pool water

The required concentration of chlorine in pool water varies with the temperature of the pool water. However it should never be less than 0.3 mg/l. Determine the required value using the table located on the left.

Chlorine content mg/l	Water temperature
0.3 to 0.5	24 to 26 °C
0.5 to 0.8	26 to 32 °C
0.8 to 1	Over 32 °C

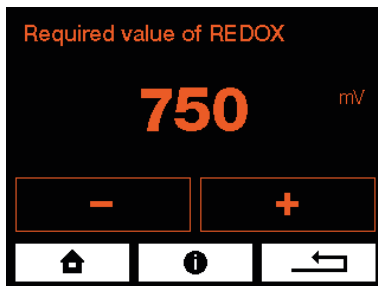

How to set the required Redox value

Set the required REDOX value to **650 mV**

Use the tester to check if the **chlorine content in pool water is within the range of 0.5 - 1.2 mg/l**.

Wait for 24 hours to let the probe stabilize.

Fine-tuning

Use the colorimeter or Pool Tester to measure the chlorine value of the pool water sample.

- If the chlorine value in pool water is **"ADEQUATE"**, your ASIN AQUA Home is prepared to maintain the required concentration of chlorine in pool water.
- If the chlorine value in pool water is **LOW**, increase the required REDOX mV value in the menu.
- If the chlorine value in pool water is **HIGH**, reduce the REDOX mV value in the menu.

Every 10 mV corresponds approximately to 0.1 mg/l of chlorine in the pool water.

EXAMPLE:

The chlorine value in the pool water is 0.3 mg/l - the displayed value is 650 mV. If you want to increase the chlorine value to 0.5 mg/l. You have to increase the preset value of the redox by 20 mV to 670 mV.

NOTE:

The relationship of Redox potential and chlorine content in pool water cannot be determined by the exact table. The correct value of the Redox must be observed by several check measurements.

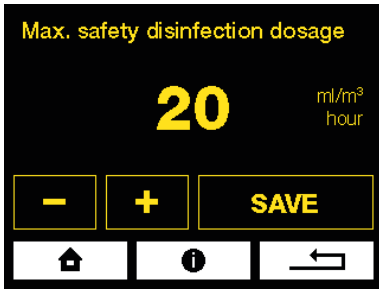

Safety Functions

Max. hourly dose of disinfection

If the maximum hourly dose of disinfection is exceeded, ASIN Aqua stops dosing and displays a warning. The error message disappears after one hour

Recommended settings:

- Indoor pool 1 – 5 ml/m³ Hr
- Outdoor pool 5 – 10 ml/m³ Hr
- Whirlpool 20 – 50 ml/m³ Hr

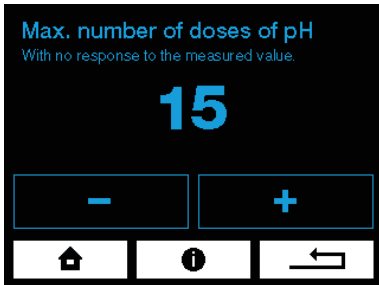
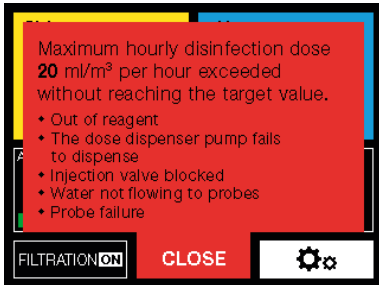

Maximum Number of pH Doses - without Probe Response

If the measured pH value does not change even after preset quantity of doses (according to the settings), ASIN AQUA Home stops pH dosing and an error message appears on the display.

The other ASIN AQUA Home functions are not limited.

The error message must be canceled by the operator.

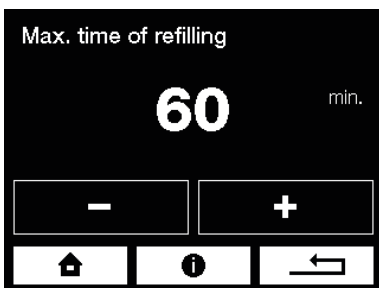
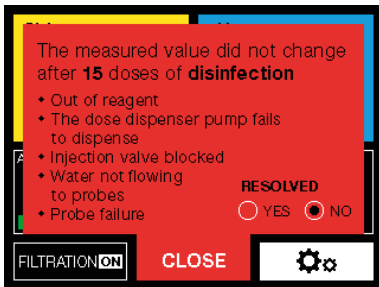

Maximum Refilling Time

The refilling of the pool is limited for the adjusted time.



In Operation Measurement and Calibration

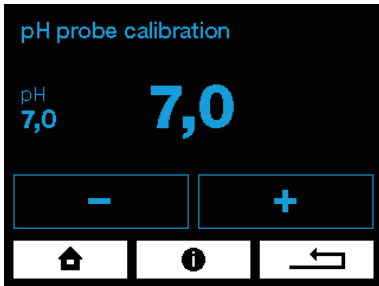

pH 7.00 Buffer #12065



pH Probe Calibration

When pH is being measured in operation, there may be a difference between the ASIN AQUA Home value and the current pH value measured directly in water.

Calibration can be done in two ways:

1. With a buffer

- **Close the water supply to the probes.**
- Remove the probe from ASIN AQUA Home : rinse the probe with clean water and wipe it.
- The probe must remain connected to the device via the cable. Immerse the probe in the 7.0 calibration buffer and after stabilization, enter this value into ASIN AQUA Home on the pH Probe Calibration screen.

2. With a colorimeter or Pool Tester

- **The water supply to the probes must be open**
- Measure the pH value directly in pool water using a colorimeter or Pool Tester.
- Then enter this value into ASIN AQUA Home on the pH Probe Calibration screen. Calibration can be performed in the range of 6.4-7.8

In Operation Measurement and Calibration

CLF Probe Calibration

Calibration rules:

Calibration is performed only for refining the value measured by the colorimeter or Pool Tester and the measured value displayed on the ASIN AQUA Home (if the difference is up to 0.2, calibration is not necessary).

The probe can be calibrated when the chlorine content in pool water corresponds to the required value or it is higher (measured with a colorimeter or Pool Tester).

Use a colorimeter or tester to measure the chlorine value in pool water. The chlorine concentration must be 0.3 to 1.2 mg/l, otherwise the calibration cannot be performed.

Calibration procedure :

Compare the value displayed on the ASIN AQUA Home with the one measured with colorimeter or Pool Tester.

1. If the difference in values is up to 0.2 mg/l, calibration is not necessary
2. If the difference in values is **higher** than 0.2 mg/l, you can calibrate the CLF probe. Go to the CLF calibration menu, set the value measured by the colorimeter or tester and save it.
3. If the difference in values is **lower** than 0.2 mg/l, the CLF probe cannot be calibrated.

Proceed as follows:

- Go to the menu required value, increase the value by 0.1 mg/l (by 0.2 mg/l max) compared to the current disinfection setting (regardless of the required value according to the table).
- After the water in the pool is mixed thoroughly and the value shown on the ASIN AQUA Home display is settled, repeat the measurement.
- **Repeat the process until the chlorine concentration in pool water matches the required value**, then set the correct required value according to the table. You can then calibrate the CLF probe.

After 24 hours, it is advisable to check the chlorine value with a colorimeter or Pool Tester. Repeat this procedure until the chlorine concentration in pool water matches the required value.

Notification: the values measured in the water may not match with the value shown on the display during the first few days before the probe stabilizes.

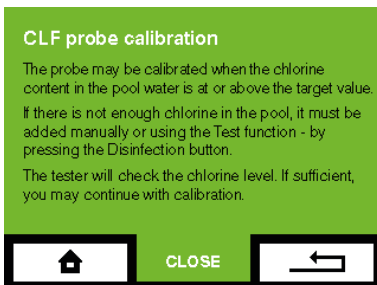
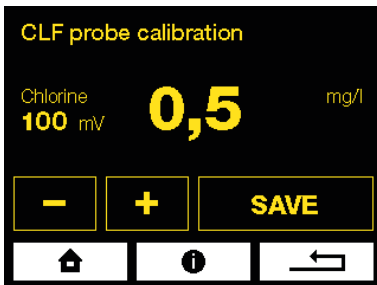

In Operation Measurement and Calibration

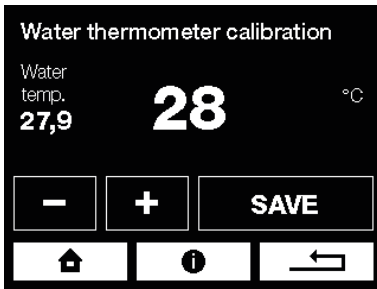

Water Thermometer Calibration

If water temperature is different from temperature shown by ASIN AQUA Home, calibrate the thermometer in the water thermometer calibration menu.

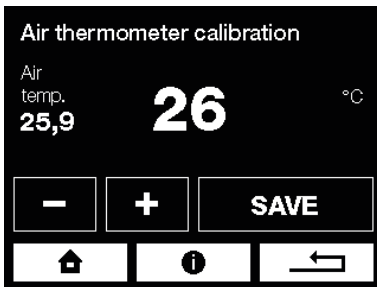

Air Thermometer Calibration

If air temperature is different from temperature shown by ASIN AQUA Home, calibrate the thermometer in the air thermometer calibration menu.

pH - Buffer 7,00 #12065



Testing the pH probe

If the probe meet following qualifications, it can be used in the system and it is functional:

Probe has no visible mechanical damage.

Measured pH value is in tolerance +/- 1,0 (example - water pH is 7,2 and probe is measuring 7,9 - the tolerance is 0,7 so lower than 1,0 - the probe is OK)

Probe response to positive or negative changes in water or buffer. (example - if you dive the probe with dry and clean tip to 7,0 pH buffer the 1 minute response must be at least 90%)

Redox Buffer 475 mV #12063



Testing the REDOX probe

If the probe meet following qualifications, it can be used in the system and it is functional:

Probe has no visible mechanical damage.

The redox probe naturally ages so its sensitivity but it should never exceed the limit tolerance - 12% At the buffer test 475 mV it should not measure less than 420 mV.

Probe response to positive or negative changes in the water free chlorine concentration.

There is no manufacturer of pH and REDOX probes that cover its products with warranty. ASEKO has decided to cover supplied probes to its clients by two year warranty period that cover free repair of supplied probe that will have higher tolerance than above described.

Internet Connection

The LAN connector is to be connected to the domestic router. Data are sent in the intervals of 10 seconds to the address **pool.aseko.com**, the route must not be blocked by the firewall.

Connection of ASIN AQUA Home to your LAN is not complicated. You just need some basic IT skills. If you are not enough skilled to setup the connection by your own ask your IT specialist for help.

Possible Connection Methods

Home network

Connect the ASIN AQUA Home to your router via LAN cable.

Mobile network

In case you have no direct internet access you can use the data transmission over the mobile network. Connect the ASIN AQUA Home to your mobile network router via LAN cable.

Wifi connection

If you install the ASIN AQUA Home in place where is no access to your private network by wired connection but your Wifi has enough signal, you can connect the ASIN AQUA Home to your Wifi by use of Wifi extender.

Powerline via 230V/DC

If you have no wired access to your LAN network but your ASIN AQUA Home is in the at the same electric network you can connect the LAN network via 230 V power line socket adapter.

If you have connection problems:

Please switch off ASIN AQUA.

Restart the router and switch on the ASIN AQUA again.

The home network must be open to communication on both sides for URL: **pool.aseko.com**

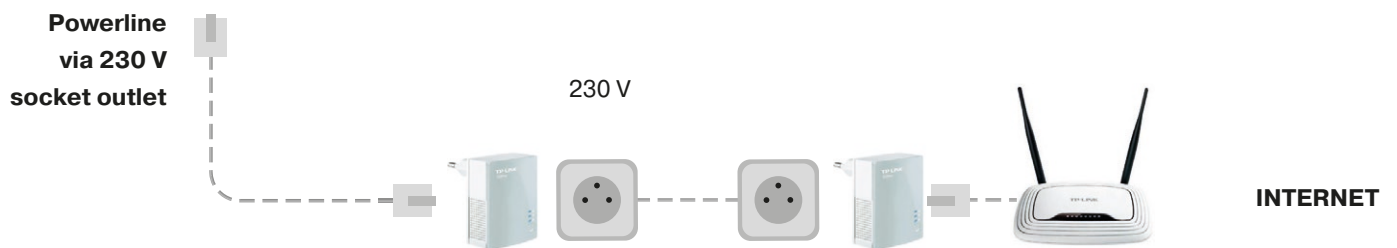
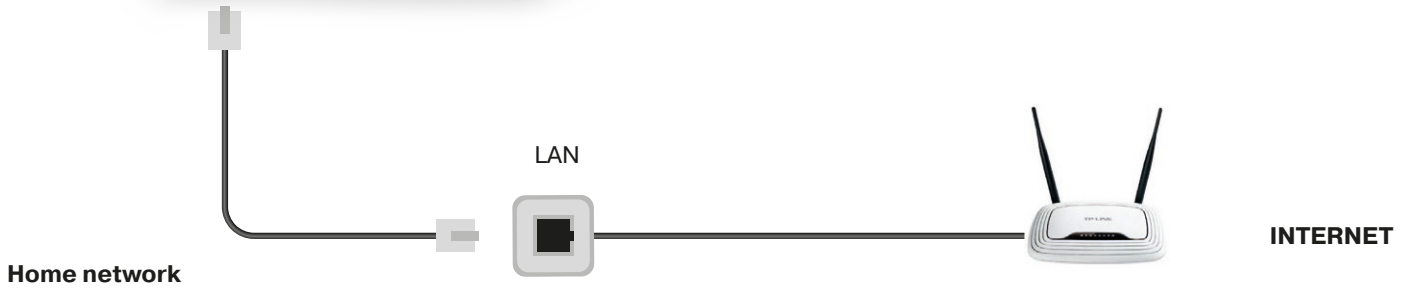

Aseko Web Services

Pool Live

The internet connection allows you to use the iPool Live mobile application and monitor your pool on mobile devices wheresoever the internet connection is available.

After you connect the ASIN AQUA Home to the internet download the iPool Live application to your smartphone. Application is available for iOS and Android operation systems.

Main screen after opening will ask for typing your ASIN AQUA Home serial number. If you have more pools equipped by the ASEKO NET adapter you can load all of them to one application.

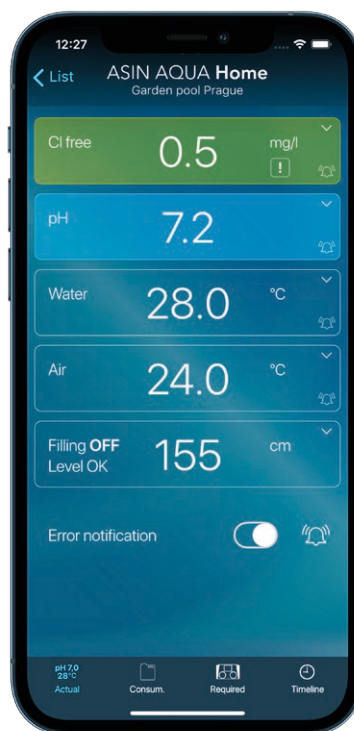
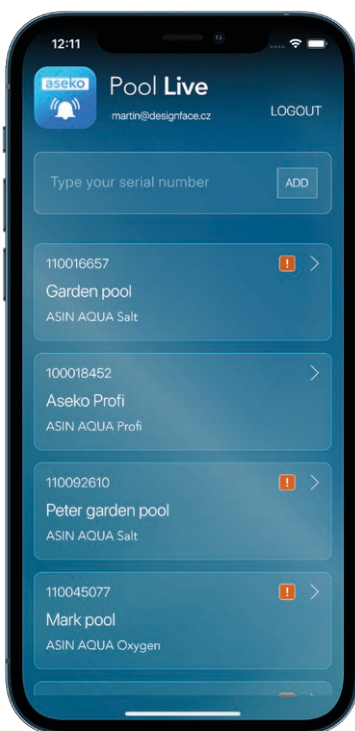

Pool LIVE
for iOS



Pool LIVE
for Android



<https://pool.aseko.com>

The web application for detailed monitoring of the pool water quality by means of well-arranged graphs. It shows all the measured parameters as well as ASIN AQUA Home actions up to 30 days back.

This application is giving you the detailed information of the pool status and detailed review of all events, taken actions and act levels of monitored items up to 30 days back.

Transparent graphic environment of chart lines is giving fast report and you can easily see interconnection of monitored values.

This application is useful at public pool installations where you need to observe the history and monitor the pool water quality and maintenance. In case of any discrepancy in water quality you can find all actions, provided in that moment and in relation to other values you can diagnose the reason of such discrepancy.

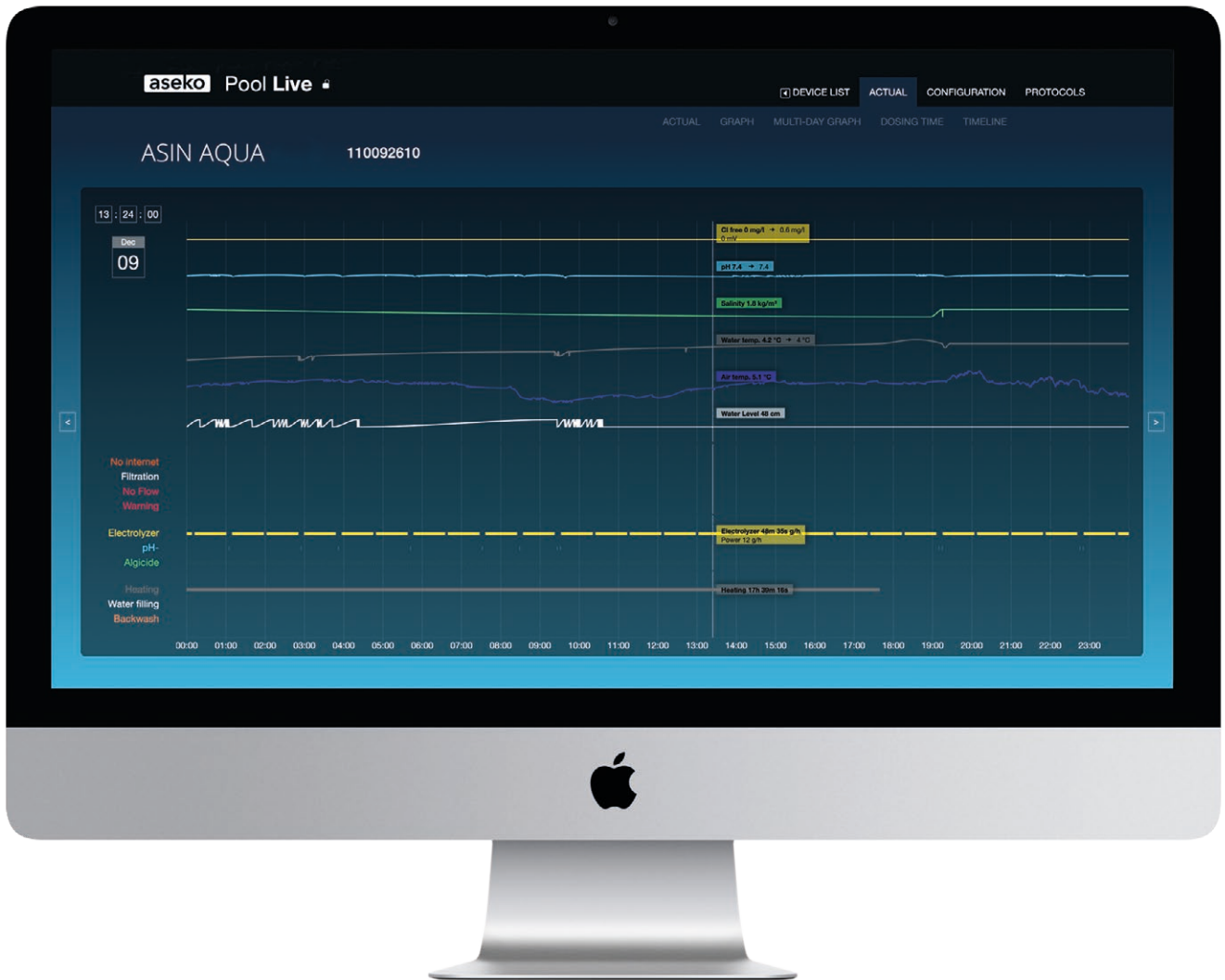

Maintenance

#12073 Replacement hose for the pump PP 60

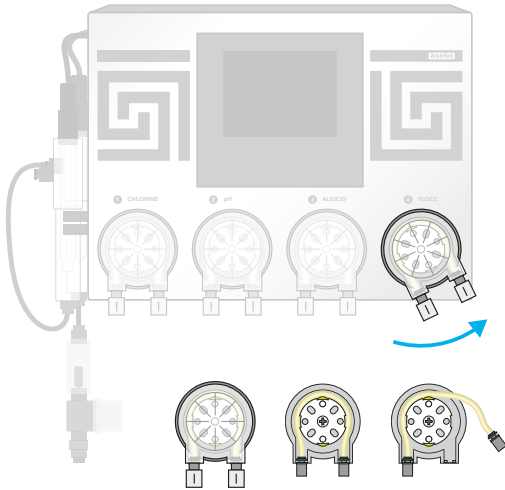

To ensure the optimum efficiency, perform visual checks and maintenance of ASIN AQUA Home on a regular basis.

Pump Hose Replacement

To prevent the pump from failing, it is recommended to replace the hose #12073 every 24 months.

In doing so, proceed as follows:

- Switch off ASIN AQUA Home.
- Turn the pump cover cassette anticlockwise and take it out of ASIN AQUA Home.
- Release both hose ends and take it out of the cassette.
- Lubricate the new hose with the supplied special grease.
- Insert the lubricated hose into the cassette.
- Place the cover cassette back on ASIN AQUA Home and turn it clockwise to lock it.
- Use new nuts, which are part of the replacement hose set, for connection of the PE tube.

#12005 Injection valve



#13087 Replacement rubber band for injection valve



Injection Valve Maintenance

On a regular basis, check throughput of the injection valves, rubber band integrity, remove scale.

In case of private pools, replace injection valve rubber bands every 2 years. In case of public pools, replace #12005 every year.

#12012 pH probe



pH Probe Maintenance

Take the pH probe out of ASIN AQUA Home housing and clean it from impurities.

Follow the instructions attached to the used probe.

Error messages

Agent Run Out

- Check liquid levels on a regular basis, refill in time.

Dosing Pump does not Dose

- Leakage in connection of PE tubes or they are damaged.
- Failure of dosing pump. Check whether pump is running. If so, check the hose inside the pump for damage or breakage and replace it, if required.

Injection Valve Clogged

- Impassable spray valve.
Check the valve for being clogged with impurities or deposits or the rubber seal for being damaged.
- Failure of dosing pump. Check whether pump is running.
If so, check the hose inside the pump for damage or breakage and replace it, if required.

No Water Flow to Probe

- Check the measured water filter and clean it, if required.
- Check condition of connecting tubes from the extraction valve to the measured water inlet to probes and furthermore, from the water outlet from probes to the closing valve.
- Check condition of the extraction valve and the closing valve and their seals, for being clogged and their closed position.

Probe out of Service

- Measure pH using the hand tester. If the pH value is too low, a respective agent was overdosed due to an incorrect probe function (provided that other reasons given in the previous points have been excluded).
- Take the probe out and check it for mechanical damage.
- Clean the probe following the above procedure.
- It is recommended to replace the probes with the new probes every two years.

Too Rapid pH Change

Too rapid change of pH is usually caused by refilling water directly to the skimmer. If such rapid change of pH occur, ASIN AQUA Home stops controlling pH for two hours.

This limitation can be manually disabled.

After pH has been stabilized or two hours have elapsed, ASIN AQUA Home changes over to the normal mode.

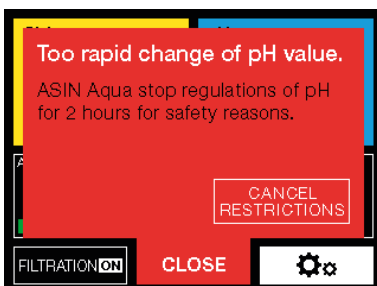
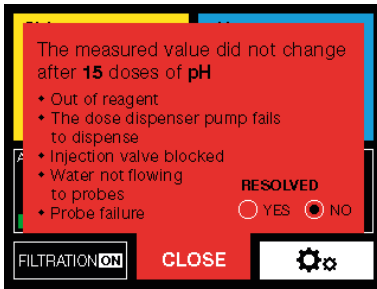

Externes Touchscreen Display



External
Touchscreen Display
#12048

The external display shows

1. Pool water parameters:
Temperature, pH value, redox potential or chlorine concentration.
2. Parameters of the air in the pool area:
relative humidity and temperature.

The setpoints can be set on the ASIN AQUA device and a probe calibration can be carried out via the external display.

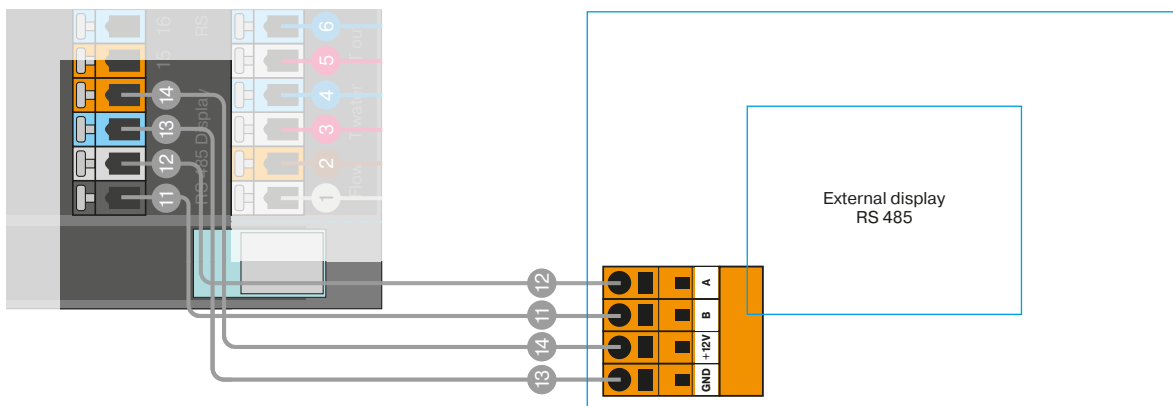

Enhancement of filtering efficiency



AFM® activated filter media

AFM is direct substitute for filter sand. It doubles efficiency of the existing filtration system. AFM® is resistant to biological pollution and formation of so-called bio-film.



ZPM® coagulation mixer

ZPM increases effects of coagulation and flocculation for transition of smaller dissolved solids (turbidity) to larger particles that can be removed by filtering.

FLOCC

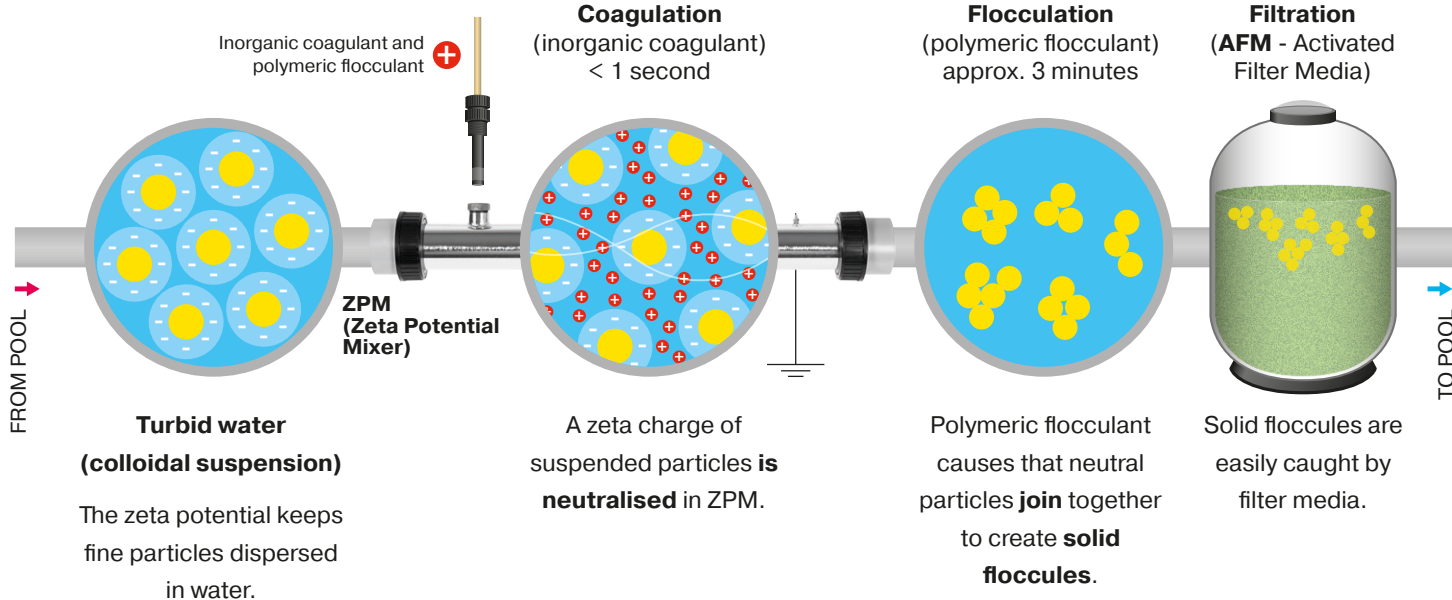



USER MANUAL

ASIN AQUA **Home VS**

