

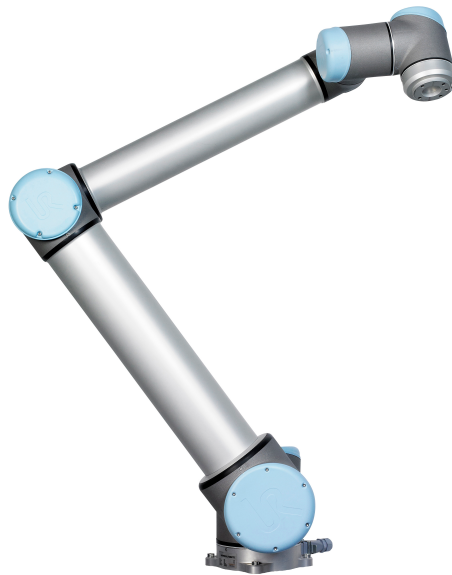

UNIVERSAL ROBOTS

Universal Robots



UR10 / CB3

Original instructions (en)

US version



UNIVERSAL ROBOTS

Universal Robots

UR10/CB3

Euromap67

Version 3.11

Original instructions (en)

US Version

The information contained herein is the property of Universal Robots A/S and shall not be reproduced in whole or in part without prior written approval of Universal Robots A/S. The information herein is subject to change without notice and should not be construed as a commitment by Universal Robots A/S. This manual is periodically reviewed and revised.

Universal Robots A/S assumes no responsibility for any errors or omissions in this document.

Copyright © 2009–2019 by Universal Robots A/S

The Universal Robots logo is a registered trademark of Universal Robots A/S.

Contents

Preface	xi
What Do the Boxes Contain	xi
Important Safety Notice	xii
How to Read This Manual	xii
Where to Find More Information	xii
UR+	xii
I Hardware Installation Manual	I-1
1 Safety	I-3
1.1 Introduction	I-3
1.2 Validity and Responsibility	I-3
1.3 Limitation of Liability	I-4
1.4 Warning Symbols in this Manual	I-4
1.5 General Warnings and Cautions	I-5
1.6 Intended Use	I-8
1.7 Risk Assessment	I-8
1.8 Emergency Stop	I-10
1.9 Movement With and Without Drive Power	I-10
2 Safety-related Functions and Interfaces	I-13
2.1 Introduction	I-13
2.2 Stopping times of the Safety System	I-14
2.3 Limiting Safety-related Functions	I-14
2.4 Safety Modes	I-15
2.5 Safety-related Electrical Interfaces	I-17
2.5.1 Safety-related Electrical Inputs	I-17
2.5.2 Safety-related Electrical Outputs	I-18
3 Transportation	I-21
4 Mechanical Interface	I-23
4.1 Introduction	I-23
4.2 Workspace of the Robot	I-23
4.3 Mounting	I-23
4.4 Maximum Payload	I-28

5	Electrical Interface	I-29
5.1	Introduction	I-29
5.2	Electrical warnings and cautions	I-29
5.3	Controller I/O	I-31
5.3.1	Common specifications for all digital I/O	I-31
5.3.2	Safety I/O	I-33
5.3.3	General purpose digital I/O	I-37
5.3.4	Digital input from a button	I-38
5.3.5	Communication with other machines or PLCs	I-38
5.3.6	General purpose analog I/O	I-38
5.3.7	Remote ON/OFF control	I-40
5.4	Tool I/O	I-41
5.4.1	Tool Digital Outputs	I-42
5.4.2	Tool Digital Inputs	I-43
5.4.3	Tool Analog Inputs	I-44
5.5	Ethernet	I-45
5.6	Mains connection	I-45
5.7	Robot connection	I-46
6	Maintenance and Repair	I-49
6.1	Safety Instructions	I-49
7	Disposal and Environment	I-51
8	Certifications	I-53
8.1	Third Party Certification	I-53
8.2	Supplier Third Party Certification	I-54
8.3	Manufacturer Test Certification	I-54
8.4	Declarations According to EU directives	I-54
9	Warranties	I-55
9.1	Product Warranty	I-55
9.2	Disclaimer	I-56
A	Stopping Time and Stopping Distance	I-57
A.1	Stop Category 0 stopping distances and times	I-57
B	Declarations and Certificates	I-59
B.1	EU Declaration of Incorporation in accordance with ISO/IEC 17050-1:2010	I-59
B.2	Safety System Certificate	I-61
B.3	TUV Rheinland	I-62
B.4	China RoHS	I-63
B.5	KCC Safety	I-64
B.6	Environmental Test Certificate	I-65
B.7	EMC Test Certificate	I-66

B.8	Cleanroom Test Certificates	I-67
C	Applied Standards	I-69
D	Technical Specifications	I-77
E	Safety Functions Tables	I-79
E.1	Table 1	I-79
E.2	Table 2	I-82
II	PolyScope Manual	II-1
10	Safety Configuration	II-3
10.1	Introduction	II-3
10.2	Changing the Safety Configuration	II-5
10.3	Safety Synchronization and Errors	II-5
10.4	Tolerances	II-6
10.5	Safety Checksum	II-7
10.6	Safety Modes	II-7
10.7	Freedrive Mode	II-7
10.7.1	Backdrive	II-8
10.8	Password Lock	II-8
10.9	Apply	II-8
10.10	General Limits	II-9
10.11	Joint Limits	II-11
10.12	Boundaries	II-12
10.12.1	Selecting a boundary to configure	II-13
10.12.2	3D visualization	II-14
10.12.3	Safety plane configuration	II-14
10.12.4	Tool Boundary configuration	II-18
10.13	Safety I/O	II-20
10.13.1	Input Signals	II-20
10.13.2	Output Signals	II-22
11	Begin programming	II-25
11.1	Introduction	II-25
11.2	Getting Started	II-25
11.2.1	Installing the Robot Arm and Control Box	II-25
11.2.2	Turning the Control Box On and Off	II-26
11.2.3	Turning the Robot Arm On and Off	II-26
11.2.4	Quick Start	II-27
11.2.5	The First Program	II-27
11.3	PolyScope Programming Interface	II-28
11.4	Welcome Screen	II-30

11.5	Initialization Screen	II-31
12	On-screen Editors	II-33
12.1	On-screen Expression Editor	II-33
12.2	Pose Editor Screen	II-33
13	Robot Control	II-37
13.1	Move Tab	II-37
13.1.1	Robot	II-37
13.1.2	Feature and Tool Position	II-38
13.1.3	Move Tool	II-38
13.1.4	Move Joints	II-38
13.1.5	Freedrive	II-38
13.2	I/O Tab	II-39
13.3	MODBUS	II-40
13.4	AutoMove Tab	II-41
13.5	Installation → Load/Save	II-42
13.6	Installation → TCP Configuration	II-43
13.6.1	Adding, renaming, modifying and removing TCPs	II-44
13.6.2	Active TCP	II-44
13.6.3	Default TCP	II-44
13.6.4	Teaching TCP position	II-44
13.6.5	Teaching TCP orientation	II-45
13.6.6	Payload	II-45
13.6.7	Center of gravity	II-46
13.7	Installation → Mounting	II-46
13.8	Installation → I/O Setup	II-47
13.8.1	I/O Signal Type	II-48
13.8.2	Assigning User-defined Names	II-48
13.8.3	I/O Actions and I/O Tab Control	II-48
13.9	Installation → Safety	II-49
13.10	Installation → Variables	II-49
13.11	Installation → MODBUS client I/O Setup	II-50
13.12	Installation → Features	II-54
13.12.1	Using a feature	II-55
13.12.2	New Point	II-56
13.12.3	New Line	II-56
13.12.4	Plane Feature	II-58
13.12.5	Example: Manually Updating a Feature to Adjust a Program	II-58
13.12.6	Example: Dynamically Updating a Feature Pose	II-59
13.13	Conveyor Tracking Setup	II-60
13.14	Smooth Transition Between Safety Modes	II-61
13.14.1	Adjusting Acceleration/Deceleration Settings	II-61
13.15	Installation → Default Program	II-62

13.16 Log Tab	II-63
13.16.1 Saving Error Reports	II-64
13.17 Load Screen	II-65
13.18 Run Tab	II-67
14 Programming	II-69
14.1 New Program	II-69
14.2 Program Tab	II-70
14.2.1 Program Tree	II-70
14.2.2 Program Execution Indication	II-71
14.2.3 Search Button	II-71
14.2.4 Undo/Redo Buttons	II-72
14.2.5 Program Dashboard	II-72
14.3 Variables	II-73
14.4 Command: Move	II-73
14.5 Command: Fixed Waypoint	II-77
14.6 Command: Relative Waypoint	II-83
14.7 Command: Variable Waypoint	II-84
14.8 Command: Direction	II-84
14.9 Command: Until	II-85
14.10 Command: Wait	II-87
14.11 Command: Set	II-88
14.12 Command: Popup	II-89
14.13 Command: Halt	II-90
14.14 Command: Comment	II-91
14.15 Command: Folder	II-92
14.16 Command: Loop	II-93
14.17 Command: If	II-93
14.18 Command: SubProgram	II-95
14.19 Command: Assignment	II-97
14.20 Command: Script	II-98
14.21 Command: Event	II-99
14.22 Command: Thread	II-100
14.23 Command: Switch	II-101
14.23.1 Timer	II-102
14.24 Command: Pattern	II-103
14.25 Command: Force	II-104
14.26 Command: Pallet	II-108
14.27 Command: Seek	II-109
14.28 Command: Conveyor Tracking	II-113
14.29 Command: Suppress	II-113
14.30 Graphics Tab	II-113
14.31 Structure Tab	II-115

14.32 Variables Tab	II-116
14.33 Command: Variables Initialization	II-117
15 Setup Screen	II-119
15.1 Language and Units	II-120
15.2 Update Robot	II-121
15.3 Set Password	II-122
15.4 Calibrate Screen	II-123
15.5 Setup Network	II-124
15.6 Set Time	II-125
15.7 URCaps Setup	II-126
III EUROMAP 67 Interface	III-1
16 Introduction	III-3
16.1 EUROMAP 67 standard	III-4
16.2 Statutory notice	III-4
17 Robot and IMM integration	III-7
17.1 Emergency stop and safeguard stop	III-7
17.2 Connecting a MAF light guard	III-7
17.3 Mounting the robot and tool	III-8
17.4 Using the robot without an IMM	III-8
17.5 EUROMAP 12 to EUROMAP 67 conversion	III-8
18 GUI	III-11
18.1 EUROMAP 67 program template	III-11
18.2 I/O overview and troubleshooting	III-12
18.2.1 Control	III-13
18.2.2 Manufacturer dependent	III-14
18.2.3 Safety	III-14
18.2.4 Status	III-14
18.3 Program structure functionality	III-14
18.3.1 Startup Check	III-15
18.3.2 Free to Mould	III-16
18.3.3 Wait for Item	III-17
18.3.4 Ejector Forward	III-18
18.3.5 Ejector Back	III-19
18.3.6 Core Pullers In	III-20
18.3.7 Core Pullers Out	III-20
18.4 I/O action and wait	III-21

Copyright © 2009–2019 by Universal Robots A/S. All rights reserved.

19 Installing and uninstalling the interface	III-23
19.1 Installing	III-23
19.2 Uninstalling	III-24
20 Electrical characteristics	III-27
20.1 MAF light guard interface	III-27
20.2 Emergency stop, safety devices and MAF signals	III-27
20.3 Digital Inputs	III-28
20.4 Digital Outputs	III-28
Glossary	III-29
Index	III-31

Copyright © 2009–2019 by Universal Robots A/S. All rights reserved.

Preface

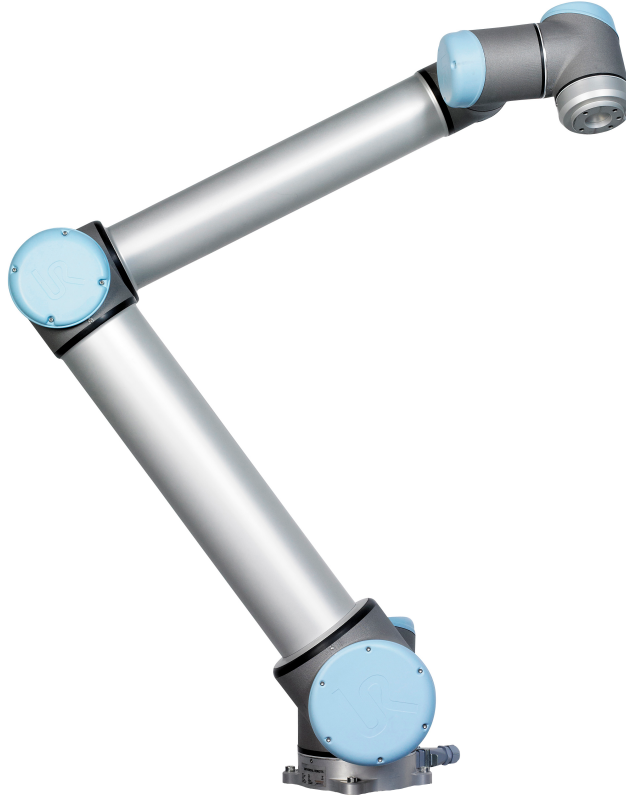

Congratulations on the purchase of your new Universal Robots robot, UR10.

The robot can be programmed to move a tool, and communicate with other machines using electrical signals. It is an arm composed of extruded aluminium tubes and joints.

Using our patented programming interface, PolyScope, it is easy to program the robot to move the tool along a desired trajectory.

What Do the Boxes Contain

When you order a robot, you receive two boxes. One contains the Robot Arm, the other contains:

- Control Box with Teach Pendant
- Mounting bracket for the Control Box
- Mounting bracket for the Teach Pendant
- Key for opening the Control Box
- Cable for connecting the robot arm and the Control Box

- Mains cable or Power cable compatible to your region
- EUROMAP 67 cable
- Stylus pen with laser
- This manual

Important Safety Notice

The robot is **partly completed machinery** (see 8.4) and as such a risk assessment is required for each installation of the robot. You must follow all of the safety instructions in chapter 1.

How to Read This Manual

This manual contains instructions for installing and programming the robot. The manual is separated into two parts:

Hardware Installation Manual: The mechanical and electrical installation of the robot.

PolyScope Manual: Programming of the robot.

EUROMAP 67 Interface: Using the EUROMAP 67 interface.

This manual is intended for the robot integrator who must have a basic level of mechanical and electrical training, as well as be familiar with elementary programming concepts.

Where to Find More Information

The support website (<http://www.universal-robots.com/support>) contains the following:

- Other language versions of this manual
- **PolyScope Manual**
- The **Service Manual** with instructions for troubleshooting, maintenance and repair
- The **Script Manual** for advanced users

UR+

The UR+ site (<http://www.universal-robots.com/plus/>) is an online showroom that provides cutting-edge products to customize your UR robot application. You can find everything you need in one place—from end-effectors and accessories to vision cameras and software. All products are tested and approved to integrate with UR robots, ensuring simple set-up, reliable operation, smooth user experience, and easy programming. You can also use the site to join the UR+ Developer Program to access our new software platform which allows you to design more user-friendly products for UR robots.

Part I

Hardware Installation Manual

1 Safety

1.1 Introduction

This chapter contains important safety information, which must be read and understood by the integrator of UR robots before the robot is powered on for the first time.

In this chapter, the first subsections are general. The later subsections contain specific engineering data relevant to enable setting up and programming the robot. `Chapter 2` describes and defines safety-related functions particularly relevant for collaborative applications.

Instructions and guidance provided in `chapter 2` as well as in `section 1.7` are particularly important.

It is essential to observe and follow all assembly instructions and guidance provided in other chapters and parts of this manual.

Special attention shall be paid to text associated with warning symbols.



NOTE:

Universal Robots disclaims any and all liability if the robot (arm control box and/or teach pendant) is damaged, changed or modified in any way. Universal Robots cannot be held responsible for any damages caused to the robot or any other equipment due to programming errors or malfunctioning of the robot.

1.2 Validity and Responsibility

The information in this manual does not cover designing, installing and operating a complete robot application, nor does it cover all peripheral equipment that can influence the safety of the complete system. The complete system must be designed and installed in accordance with the safety requirements set forth in the standards and regulations of the country where the robot is installed.

The integrators of UR robots are responsible for ensuring that the applicable safety laws and regulations in the country concerned are observed and that any significant hazards in the complete robot application are eliminated.

This includes, but is not limited to:

- Performing a risk assessment for the complete robot system
- Interfacing other machines and additional safety devices if defined by the risk assessment
- Setting up the appropriate safety settings in the software
- Ensuring that the user will not modify any safety measures
- Validating that the total robot system is designed and installed correctly

- Specifying instructions for use
- Marking the robot installation with relevant signs and contact information of the integrator
- Collecting all documentation in a technical file; including the risk assessment and this manual

1.3 Limitation of Liability

Any safety information provided in this manual must not be construed as a warranty, by UR, that the industrial manipulator will not cause injury or damage, even if industrial manipulator complies with all safety instructions.

1.4 Warning Symbols in this Manual

The symbols below define the captions specifying the danger levels used throughout this manual. The same warning signs are used on the product.

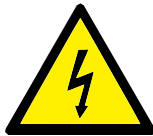

DANGER:

This indicates an imminently hazardous electrical situation which, if not avoided, could result in death or serious injury.



DANGER:

This indicates an imminently hazardous situation which, if not avoided, could result in death or serious injury.



WARNING:

This indicates a potentially hazardous electrical situation which, if not avoided, could result in injury or major damage to the equipment.



WARNING:

This indicates a potentially hazardous situation which, if not avoided, could result in injury or major damage to the equipment.



WARNING:

This indicates a potentially hazardous hot surface which, if touched, could result in injury.



CAUTION:

This indicates a situation which, if not avoided, could result in damage to the equipment.

1.5 General Warnings and Cautions

This section contains some general warnings and cautions that can be repeated or explained in different parts of this manual. Other warnings and cautions are present throughout this manual.



DANGER:

You must install the robot and all electrical equipment according to the specifications and warnings found in `chapters 4 and 5`.

**WARNING:**

1. Make sure the robot arm and tool/end effector are properly and securely bolted in place.
2. Make sure the robot arm has ample space to operate freely.
3. Make sure that safety measures and/or robot safety configuration parameters have been set up to protect both programmers, operators and bystanders, as defined in the risk assessment.
4. Do not wear loose clothing or jewellery when working with the robot. Make sure long hair is tied back when working with the robot.
5. Never use the robot if it is damaged. For example, if joint caps are loose, broken or removed.
6. If the software prompts an error, immediately press emergency stop, write down the conditions that led to the error, find the corresponding error codes on the log screen, and contact your supplier.
7. Do not connect any safety equipment to standard I/O. Use safety-related I/O only.
8. Make sure to use the correct installation settings (e.g. Robot mounting angle, mass in TCP, TCP offset, safety configuration). Save and load the installations file along with the program.
9. The freedrive function (Impedance/Backdrive) shall only be used in installations where the risk assessment allows it. Tool/end effectors and obstacles shall not have sharp edges or pinch points.
10. Make sure to warn people to keep their heads and faces outside the reach of the operating robot or robot about to start operating.
11. Be aware of robot movement when using the teach pendant.
12. If determined by the risk assessment, do not enter the safety range of the robot or touch the robot when the system is in operation.

13. Collisions can release high levels of kinetic energy, which are significantly higher at high speeds and with high payloads. (Kinetic Energy = $\frac{1}{2} \text{Mass} \cdot \text{Speed}^2$)
14. Combining different machines can increase hazards or create new hazards. Always make an overall risk assessment for the complete installation. Depending on the assessed risk, different levels of functional safety can apply; as such, when different safety and emergency stop performance levels are needed, always choose the highest performance level. Always read and understand the manuals for all equipment used in the installation.
15. Never modify the robot. A modification might create hazards that are unforeseen by the integrator. All authorized reassembling shall be done according to the newest version of all relevant service manuals.
16. If the robot is purchased with an extra module (e.g. euomap67 interface) then look up that module in the respective manual.

**WARNING:**

1. The robot and its controller box generate heat during operation. Do not handle or touch the robot while in operation or immediately after operation as prolonged contact can cause discomfort. To cool the robot down, power off the robot and wait one hour.
2. Never stick fingers behind the internal cover of the controller box.

**CAUTION:**

1. When the robot is combined, or working, with machines capable of damaging the robot, it is highly recommended to test all functions and the robot program separately. It is also recommended to test the robot program using temporary waypoints outside the workspace of other machines.
2. Do not expose the robot to permanent magnetic fields. Very strong magnetic fields can damage the robot.

1.6 Intended Use

UR robots are industrial robots intended to handle tools/end effectors and fixtures, or to process or transfer components or products. For details about the environmental conditions under which the robot should operate, see appendices B and D.

UR robots are equipped with special safety-related features, which are purposely designed to enable collaborative operation, where the robot system operates without fences and/or together with a human.

Collaborative operation is only intended for non-hazardous applications, where the complete application, including tool/end effector, work piece, obstacles and other machines, is without any significant hazards according to the risk assessment of the specific application.

Any use or application deviating from intended use is deemed to be impermissible misuse. This includes, but is not limited to:

- Use in potentially explosive environments
- Use in medical and life critical applications
- Use before performing a risk assessment
- Use outside of stated specifications
- Use as a climbing aid
- Operation outside the permissible operating parameters

1.7 Risk Assessment

One of the most important things that an integrator needs to do is to perform a risk assessment. In many countries this is required by law. The robot itself is partly completed machinery, as the safety of the robot installation depends on how the robot is integrated (E.g. tool/end effector, obstacles and other machines).

It is recommended that the integrator uses ISO 12100 and ISO 10218-2 to conduct the risk assessment. Additionally the integrator can choose to use the Technical Specification ISO/TS 15066 as additional guidance.

The risk assessment that the integrator conducts shall consider all work tasks throughout the lifetime of the robot application, including but not limited to:

- Teaching the robot during set-up and development of the robot installation
- Troubleshooting and maintenance
- Normal operation of the robot installation

A risk assessment must be conducted **before** the robot arm is powered on for the first time. A part of the risk assessment conducted by the integrator is to identify the proper safety configuration settings, as well as the need for additional emergency stop buttons and/or other protective measures required for the specific robot application.

1.7 Risk Assessment

Identifying the correct safety configuration settings is a particularly important part of developing collaborative robot applications. See *chapter 2* and *part II* for detailed information.

Some safety-related features are purposely designed for collaborative robot applications. These features are configurable through the safety configuration settings and are particularly relevant when addressing specific risks in the risk assessment conducted by the integrator:

- **Force and power limiting:** Used to reduce clamping forces and pressures exerted by the robot in the direction of movement in case of collisions between the robot and the operator.
- **Momentum limiting:** Used to reduce high transient energy and impact forces in case of collisions between robot and operator by reducing the speed of the robot.
- **TCP and tool/end effector position limiting:** Particularly used to reduce risks associated with certain body parts. E.g. to avoid movement towards head and neck.
- **TCP and tool/end effector orientation limiting:** Particularly used to reduce risks associated with certain areas and features of the tool/end effector and work-piece. E.g. to avoid sharp edges to be pointed towards the operator.
- **Speed limitation:** Particularly used to ensure a low speed of the robot arm.

The integrator must prevent unauthorized access to the safety configuration by using password protection.

A collaborative robot application risk assessment for contacts that are intentional and/or due to reasonably foreseeable misuse is required and must address:

- Severity of individual potential collisions
- Likelihood of occurrence of individual potential collisions
- Possibility to avoid individual potential collisions

If the robot is installed in a non-collaborative robot application where hazards cannot be reasonably eliminated or risks cannot be sufficiently reduced by use of the built-in safety-related functions (e.g. when using a hazardous tool/end effector), then the risk assessment conducted by the integrator must conclude the need for additional protective measures (e.g. an enabling device to protect the operator during set-up and programming).

Universal Robots identifies the potential significant hazards listed below as hazards that must be considered by the integrator.

Note: Other significant hazards can be present in a specific robot installation.

1. Entrapment of fingers between robot arm cable connector and base (Joint 0).
2. Entrapment of fingers between robot foot and base (Joint 0).
3. Entrapment of fingers between robot wrist 1 and robot wrist 2 (Joint 3 and Joint 4).
4. Penetration of skin by sharp edges and sharp points on tool/end effector or tool/end effector connector.
5. Penetration of skin by sharp edges and sharp points on obstacles near the robot track.
6. Bruising due to contact with the robot.

7. Sprain or bone fracture due to strokes between a heavy payload and a hard surface.
8. Consequences due to loose bolts that hold the robot arm or tool/end effector.
9. Items falling out of tool/end effector, e.g. due to a poor grip or power interruption.
10. Mistakes due to different emergency stop buttons for different machines.
11. Mistakes due to unauthorized changes to the safety configuration parameters.

Information on stopping times and stopping distances are found in [chapter 2](#) and [appendix A](#).

1.8 Emergency Stop

Activate the emergency stop push-button to immediately stop all robot motion.

Note: According to IEC 60204-1 and ISO 13850, emergency devices are not safeguards. They are complimentary protective measures and are not intended to prevent injury.

The risk assessment of the robot application shall conclude if additional emergency stop buttons are needed. Emergency stop push-buttons must comply with IEC 60947-5-5 (see [section 5.3.2](#)).

1.9 Movement With and Without Drive Power

In the unlikely event of an emergency situation, where one or more robot joints need to be moved and robot power is either not possible or not wanted, there are two different ways to force movements of the robot joints: Note: In a service situation, the brake on the joints can be released without connected power.

1. Forced back-driving: Force a joint to move by pushing or pulling the robot arm hard. Each joint brake has a friction clutch which enables movement during high forced torque.
2. Manual brake release: Remove the joint cover by removing the few M3 screws that fix it. Release the brake by pushing the plunger on the small electromagnet as shown in the picture below.



WARNING:

1. Moving the robot arm manually is intended for urgent emergency purposes only and might damage the joints.
2. If the brake is released manually, gravitational pull can cause the robot arm to fall. Always support the robot arm, tool/end effector and work item when releasing the brake.

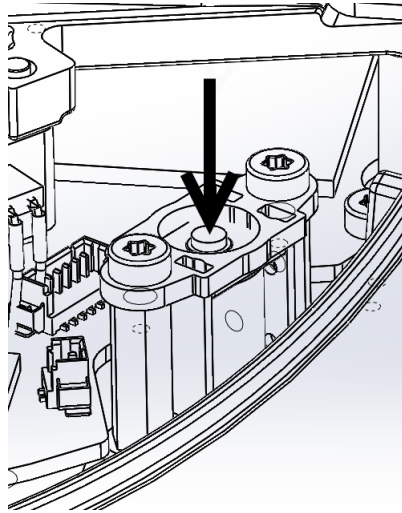

Copyright © 2009–2019 by Universal Robots A/S. All rights reserved.

Copyright © 2009–2019 by Universal Robots A/S. All rights reserved.

2 Safety-related Functions and Interfaces

2.1 Introduction

UR robots are equipped with a range of built-in safety-related functions as well as safety-related electrical interfaces to connect to other machines and additional protective devices. Each safety function and I/O is constructed according to EN ISO13849-1:2008 (see Chapter 8 for certifications) with Performance Level d (PLd).



DANGER:

Use of safety configuration parameters different from those defined by the risk assessment conducted by the integrator can result in hazards that are not reasonably eliminated or risks that are not sufficiently reduced.

See chapter 10 in part II for configuration of the safety-related features, inputs, and outputs in the user interface. See chapter 5 for descriptions on how to connect safety devices to the electrical interface.



NOTE:

1. Use and configuration of safety-related functions and interfaces must be done according to the risk assessment that the integrator conducts for a specific robot application, see section 1.7 in chapter 1.
2. If the robot discovers a fault or violation in the safety system, e.g. one of the wires in the emergency stop circuit is cut, a position sensor is broken, or a limit of a safety-related function has been violated, a Stop Category 0 is initiated. The worst case time from an error occurs to the robot is stopped is listed at the end of this chapter. This time should be taken into account as part of the risk assessment conducted by the integrator.

The robot has a number of safety-related functions that can be used to limit the movement of its joints and of the robot *Tool Center Point* (TCP). The TCP is the center point of the output flange with the addition of the TCP offset.

The limiting safety-related functions are:

Limiting Safety Function	Description
Joint position	Min. and max. angular joint position
Joint speed	Max. angular joint speed
TCP position	Planes in Cartesian space limiting robot TCP position
TCP speed	Max. speed of the robot TCP
TCP force	Max. pushing force of the robot TCP
Momentum	Max. momentum of the robot arm
Power	Max. applied robot arm power

2.2 Stopping times of the Safety System

The stopping time of the safety system is the time from a fault or violation of a safety-related function occurs to the robot is brought to a complete stop and the mechanical brakes are engaged.

The maximum stopping times in the table must be considered if the safety of the application relies upon the stopping time of the robot. E.g. if a fault in the robot results in a stop of a complete factory line, where certain actions must take place immediately after the stop, the maximum stopping times must be considered.

The measurements are conducted with the following configuration of the robot:

- Extension: 100% (the robot arm is fully extended horizontally).
- Speed: The TCP speed limit of the safety system is set to the described limit.
- Payload: maximum payload handled by the robot attached to the TCP (10 kg).

The worst case stopping time for Stop Category¹ 0 in case of a violation of the safety limits or interfaces can be seen in the following table.

TCP Speed Limit	Maximum Stopping Time
1.0 m/s	450 ms
1.5 m/s	500 ms
2.0 m/s	550 ms
1.5 m/s	600 ms
3.0 m/s	650 ms

2.3 Limiting Safety-related Functions

Advanced path control software decreases speed or issues a program execution stop if the robot arm approaches a safety-related limit. Violations of limits will hence only occur in exceptional cases. Nevertheless, if a limit is violated, the safety system issues a Stop Category 0.

¹Stop Categories are according to IEC 60204-1, see Glossary for more details.

2.4 Safety Modes

Limiting Safety Function	Worst Case			
	Trueness	Detection Time	De-energizing Time	Reaction Time
Joint position	1.15 °	100 ms	1000 ms	1100 ms
Joint speed	1.15 °/s	250 ms	1000 ms	1250 ms
TCP position	20 mm	100 ms	1000 ms	1100 ms
TCP orientation	1.15 °	100 ms	1000 ms	1100 ms
TCP speed	50 mm/s	250 ms	1000 ms	1250 ms
TCP force	25 N	250 ms	1000 ms	1250 ms
Momentum	3 kg m/s	250 ms	1000 ms	1250 ms
Power	10 W	250 ms	1000 ms	1250 ms

The system is considered *de-energized* when the 48 V bus voltage reaches an electrical potential below 7.3 V. The de-energizing time is the time from a detection of an event until the system has been de-energized.



WARNING:

There are two exceptions to the force limiting function that are important to notice when designing the work cell for the robot. These are illustrated in Figure 2.1. As the robot stretches out, the knee-joint effect can give high forces in the radial direction (away from the base), but at the same time, low speeds. Similarly, the short leverage arm, when the tool is close to the base and moving tangential (around) the base, can cause high forces, but also at low speeds. Pinching hazards can be avoided, for instance, by removing obstacles in these areas, placing the robot differently, or by using a combination of safety planes and joint limits to remove the hazard by preventing the robot moving into this region of its workspace.



WARNING:

If the robot is used in manual hand-guiding applications with linear movements, the joint speed limit must be set to maximum 40 degrees per second for the base and shoulder joints unless a risk assessment shows that speeds above 40 degrees per second are acceptable. This will prevent fast movements of the robot elbow near singularities.

2.4 Safety Modes

Normal and Reduced mode The safety system has two configurable safety modes: *Normal* and *Reduced*. Safety limits can be configured for each of these two modes. Reduced mode is active when the robot TCP is positioned beyond a *Trigger Reduced mode* plane or when triggered by a safety input. Reduced mode can be triggered either by using a plane or by using an input.

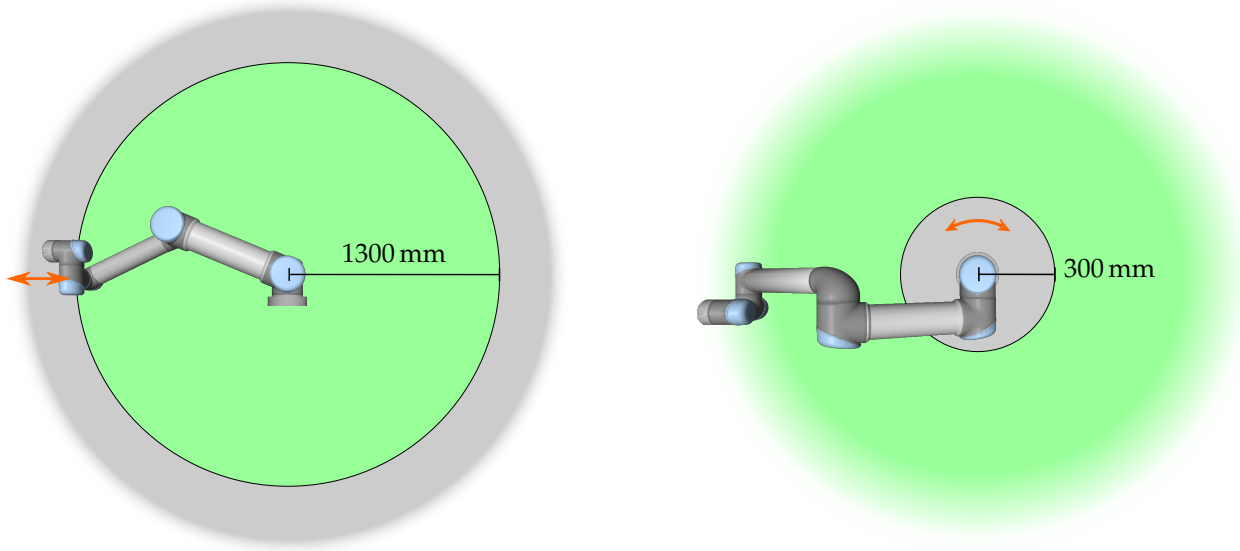

Figure 2.1: Certain areas of the workspace should receive attention regarding pinching hazards, due to the physical properties of the robot arm. One area is defined for radial motions, when the wrist 1 joint is at a distance of at least 1300 mm from the base of the robot. The other area is within 300 mm of the base of the robot, when moving in the tangential direction.

Copyright © 2009–2019 by Universal Robots A/S. All rights reserved.

Using a plane to trigger Reduced mode: When the robot moves from the Reduced mode side of the trigger plane, back to the Normal mode side, there is a 20mm area around the trigger plane where both Normal and Reduced mode limits are allowed. It prevents the safety mode from flickering if the robot is right at the limit.

Using an input to trigger Reduced mode: When an input is used (to either start or stop Reduced mode), up to 500ms can elapse before the new mode limit values are applied. This could happen either when changing Reduced mode to Normal mode OR changing Normal mode to Reduced mode. It allows the robot to adapt e.g. the speed to the new safety limits.

Recovery Mode When a safety limit is violated, the safety system must be restarted. If the system is outside a safety limit at start-up (e.g. outside a joint position limit), the special *Recovery* mode is entered. In Recovery mode it is not possible to run programs for the robot, but the robot arm can be manually moved back within limits either by using *Freedrive* mode or by using the Move tab in PolyScope (see part II “PolyScope Manual”). The safety limits of *Recovery* mode are:

Limiting Safety Function	Limit
Joint speed	30 °/s
TCP speed	250 mm/s
TCP force	100 N
Momentum	10 kgm/s
Power	80 W

The safety system issues a Stop Category 0 if a violation of these limits appears.

**WARNING:**

Notice that limits for the *joint position*, the *TCP position*, and the *TCP orientation* are disabled in Recovery Mode. Take caution when moving the robot arm back within the limits.

2.5 Safety-related Electrical Interfaces

The robot is equipped with several safety-related electrical inputs and outputs. All safety-related electrical inputs and outputs are dual channel. They are safe when low, e.g. the emergency stop is not active when the signals are high (+24V).

2.5.1 Safety-related Electrical Inputs

The table below gives an overview of the safety-related electrical inputs.

Safety Input	Description
Robot Emergency Stop	(Dedicated Input). Performs a Stop Category 1, which can be forwarded to other machines using the <i>System emergency stop</i> output when configured.
Emergency Stop Button	(Teach Pendant Button). Performs a Stop Category 1, which can be forwarded to other machines using the <i>System emergency stop</i> output when configured.
System Emergency Stop	(Configurable Input). Performs a Stop Category 1. To avoid deadlocks, this signal will not be forwarded to other machines through the <i>System emergency stop</i> output.
Safeguard Stop	(Dedicated Input). Performs a Stop Category 2.
Safeguard Reset	(Configurable Input). Resumes the robot from a <i>Safeguard stopped</i> state, when an edge on the Safeguard reset input occurs.
Reduced Mode	(Configurable Input). The safety system transitions to <i>Reduced mode</i> limits.
Three-Position Enabling Device	(Configurable Input). Functions as a safeguard stop input when the operational mode input is high.
Operational Mode	(Configurable Input). Operational mode to use when a Three-position enabling device is configured.

A Stop Category 1 and a Stop Category 2 decelerates the robot with drive power on, which enables the robot to stop without deviating from its current path.

Monitoring of safety inputs Stop Category 1 and Stop Category 2 are monitored by the safety system in the following way:

1. The safety system monitors that the braking initiates within 24 ms, see Figure 2.2.
2. If a joint is moving, its speed is monitored to never be higher than the speed obtained by constantly decelerating from the maximum joint speed limit for *Normal* mode to 0 rad/s in 500 ms.

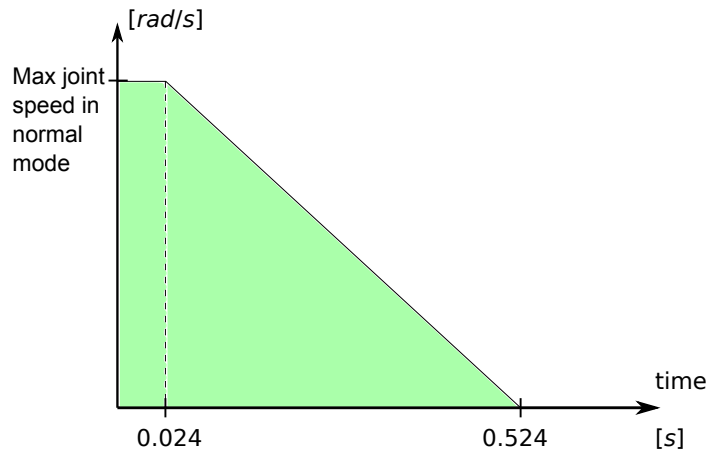

Figure 2.2: The green area below the ramp is the allowed speeds for a joint during braking. At time 0 an event (emergency stop or safeguard stop) is detected at the safety processor. Deceleration begins after 24 ms.

3. If a joint is at rest (joint speed is less than 0.2 rad/s), it is monitored that it does not move more than 0.05 rad from the position it had when the speed was measured below 0.2 rad/s .

Additionally, for a Stop Category 1, the safety system monitors that after the robot arm is at rest, the powering off is finalized within 600 ms. Furthermore, after a Safeguard Stop input, the robot arm is only allowed to start moving again after a positive edge on the safeguard reset input occurs. If any of the above properties are not satisfied, the safety system issues a Stop Category 0.

A transition to *Reduced* mode triggered by the reduced mode input is monitored as follows:

1. The safety system accepts both *Normal* and *Reduced* mode limit sets for 500 ms after the reduced mode input is triggered.
2. After 500 ms, only the *Reduced* mode limits are in effect.

If any of the above properties are not satisfied, the safety system issues a Stop Category 0.

A Stop Category 0 is performed by the safety system with the performance described in the following table. The worst-case reaction time is the time to stop and to *de-energize* (discharge to an electrical potential below 7.3 V) a robot running at full speed and payload.

Safety Input Function	Worst Case		
	Detection Time	De-energizing Time	Reaction Time
Robot Emergency Stop	250 ms	1000 ms	1250 ms
Emergency Stop Button	250 ms	1000 ms	1250 ms
System Emergency Stop	250 ms	1000 ms	1250 ms
Safeguard Stop	250 ms	1000 ms	1250 ms

2.5.2 Safety-related Electrical Outputs

The table below gives an overview of the safety-related electrical outputs:

2.5 Safety-related Electrical Interfaces

Safety Output	Description
System Emergency Stop	Logic low when the <i>Robot emergency stop</i> input is logic low or the Emergency stop button is pressed.
Robot Moving	While this signal is logic high, no single joint of the robot arm moves more than 0.1 rad.
Robot Not Stopping	Logic high when the robot is stopped or in the process of stopping due to an emergency stop or safeguard stop. Otherwise it will be logic low.
Reduced Mode	Logic low when the safety system is in <i>Reduced</i> mode.
Not Reduced Mode	The <i>Reduced mode</i> output negated.

If a safety output is not set properly, the safety system issues a Stop Category 0, with the following worst-case reaction times:

Safety Output	Worst Case Reaction Time
System Emergency Stop	1100 ms
Robot Moving	1100 ms
Robot Not Stopping	1100 ms
Reduced Mode	1100 ms
Not Reduced Mode	1100 ms

Copyright © 2009–2019 by Universal Robots A/S. All rights reserved.

3 Transportation

Transport the robot in the original packaging. Save the packaging material in a dry place; you may need to pack down and move the robot later on.

Lift both tubes of the robot arm at the same time when moving it from the packaging to the installation place. Hold the robot in place until all mounting bolts are securely tightened at the base of the robot.

The controller box shall be lifted by the handle.



WARNING:

1. Make sure not to overload your back or other bodyparts when the equipment is lifted. Use proper lifting equipment. All regional and national guidelines for lifting shall be followed. Universal Robots cannot be held responsible for any damage caused by transportation of the equipment.
2. Make sure to mount the robot according to the mounting instructions in chapter 4.

4 Mechanical Interface

4.1 Introduction

This chapter describes the basics of mounting the various parts of the robot system. Electrical installation instructions in chapter 5 must be observed.

4.2 Workspace of the Robot

The workspace of the UR10 robot extends 1300 mm from the base joint. It is important to consider the cylindrical volume directly above and directly below the robot base when a mounting place for the robot is chosen. Moving the tool close to the cylindrical volume should be avoided if possible, because it causes the joints to move fast even though the tool is moving slowly, causing the robot to work inefficiently and making it difficult to conduct a risk assessment.

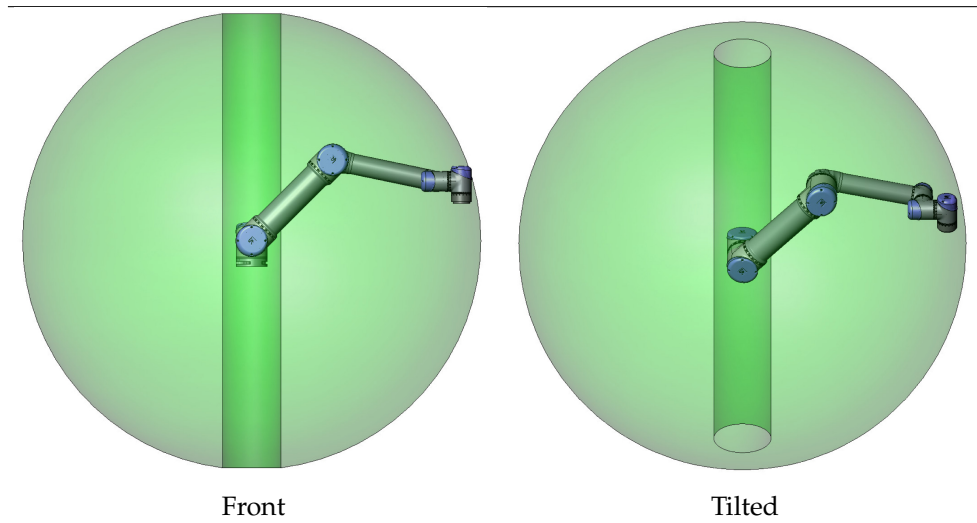

4.3 Mounting

Robot Arm The robot arm is mounted using four M8 bolts, using the four 8.5 mm holes on the base. It is recommended to tighten these bolts with 20 N m torque. If very accurate repositioning of the robot arm is desired, two $\text{Ø}8$ holes are provided for use with a pin. Also, an accurate base counterpart can be purchased as an accessory. Figure 4.1 shows where to drill holes and mount the screws.

The robot connector cable can be mounted through the side or through the bottom of the base. Mount the robot on a sturdy surface strong enough to withstand at least ten times the full torque of the base joint and at least five times the weight of the robot arm. Furthermore the surface shall be

vibration free.

If the robot is mounted on a linear axis or a moving platform then the acceleration of the moving mounting base shall be very low. A high acceleration might cause the robot to stop, thinking it bumped into something.



DANGER:

- Make sure the robot arm is properly and securely bolted in place. The mounting surface shall be sturdy.
- Remember to insert the rubber plugs in all mounting holes in the robot base to avoid entrapment of fingers.



CAUTION:

Mount the robot in an environment suited to the IP rating. The robot must not be operated in environments that exceed those corresponding to the IP ratings of the robot (IP54), Teach Pendant (IP54) and Control Box (IP44)

Tool The robot tool flange has four M6 thread holes for attaching a tool to the robot. The M6 bolts need to be tightened with 9 N m. If very accurate repositioning of the tool is desired, the Ø6 hole is provided for use with a pin. Figure 4.2 shows where to drill holes and mount the screws.



DANGER:

1. Make sure the tool is properly and securely bolted in place.
2. Make sure that the tool is constructed such that it cannot create a hazardous situation by dropping a part unexpectedly.

Control Box The control box can be hung on a wall, or it can be placed on the ground. A clearance of 50 mm on each side is needed for sufficient airflow. Extra brackets for mounting can be bought.

Teach Pendant The teach pendant can be hung on a wall or on the control box. Extra brackets for mounting the teach pendant can be bought. Make sure that no one can trip over the cable.

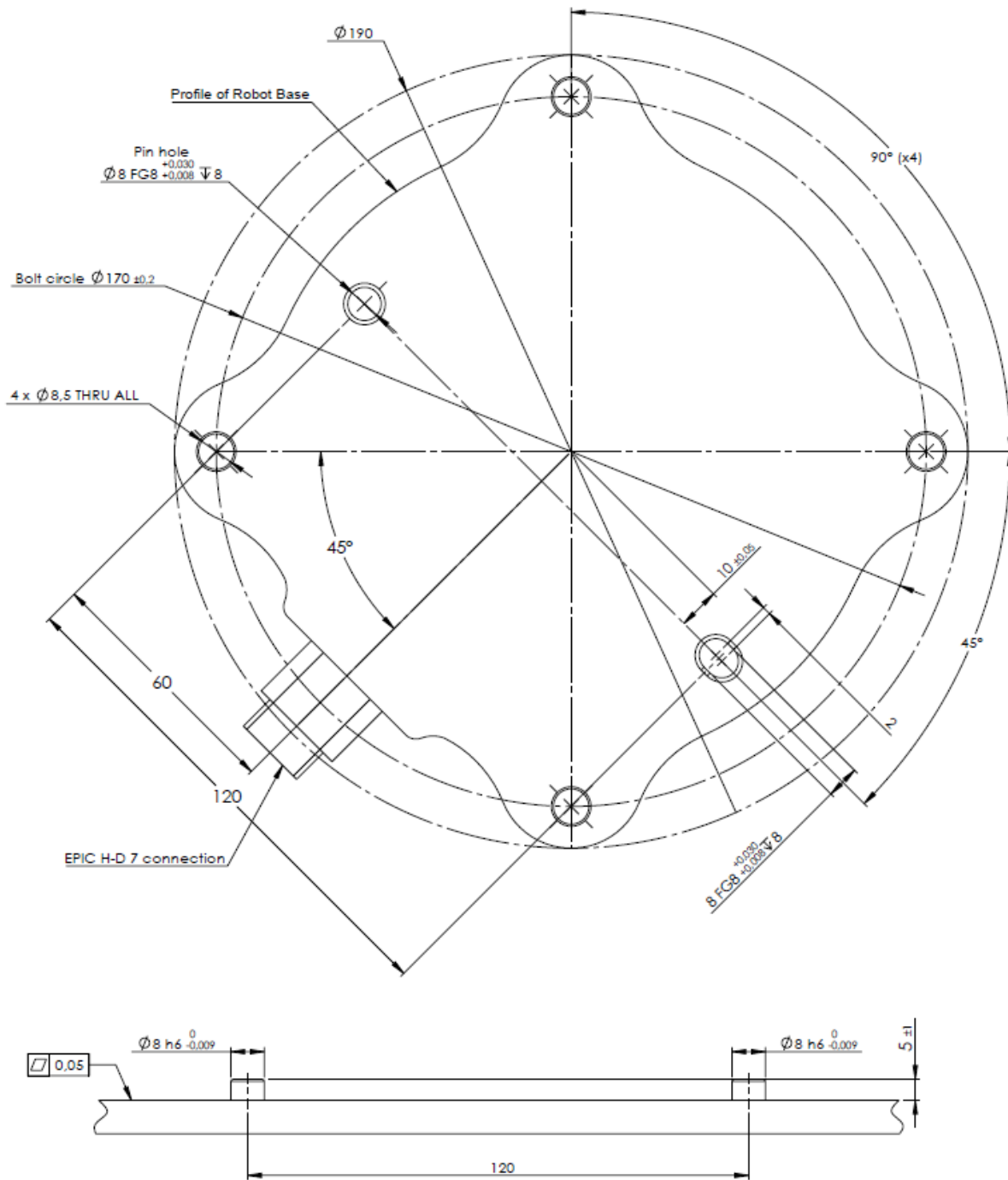

Figure 4.1: Holes for mounting the robot. Use four M8 bolts. All measurements are in mm.

Copyright © 2009–2019 by Universal Robots A/S. All rights reserved.

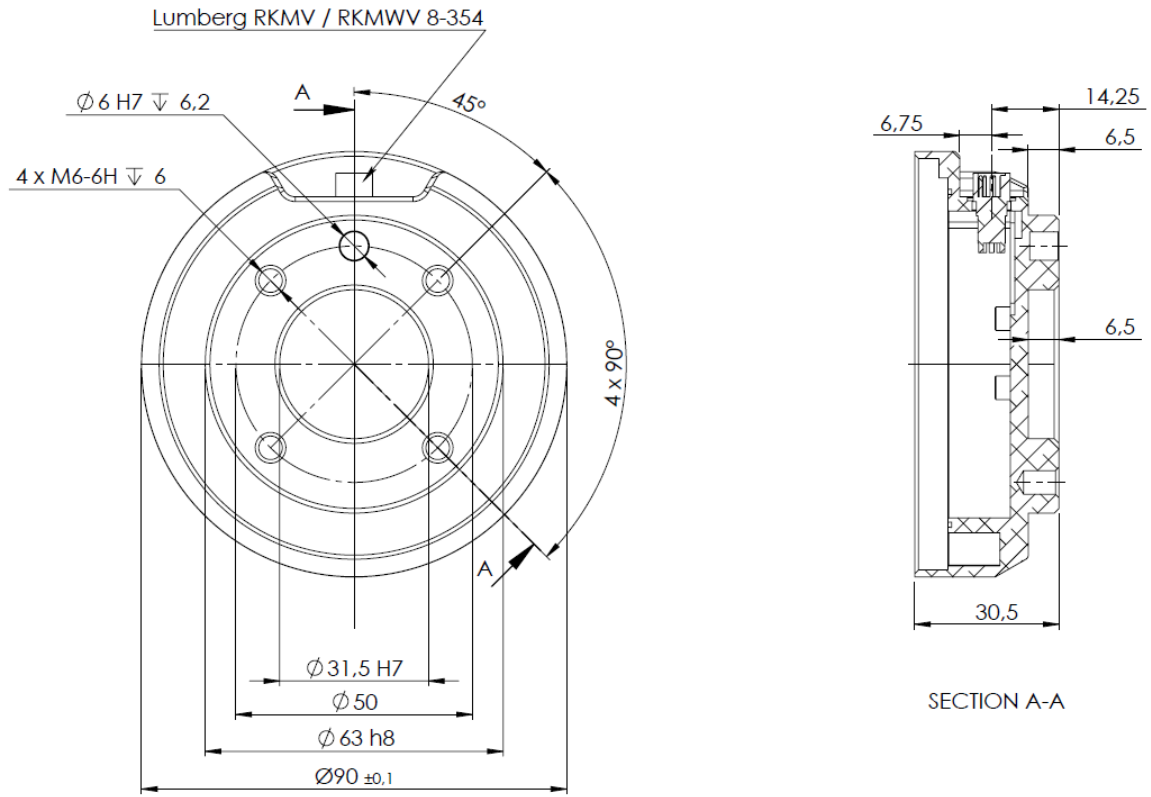

Figure 4.2: The tool output flange, ISO 9409-1-50-4-M6. This is where the tool is mounted at the tip of the robot. All measures are in mm.

Copyright © 2009–2019 by Universal Robots A/S. All rights reserved.



DANGER:

1. Make sure that the control box, teach pendant, and cables do not come into contact with liquids. A wet control box could cause death.
2. The control box and teach pendant must not be exposed to dusty or wet environments that exceed IP20 rating. Pay special attention to environments with conductive dust.

4.4 Maximum Payload

The maximum allowed payload of the robot arm depends on the *center of gravity offset*, see figure 4.3. The center of gravity offset is defined as the distance between the center of the tool output flange and the center of gravity.

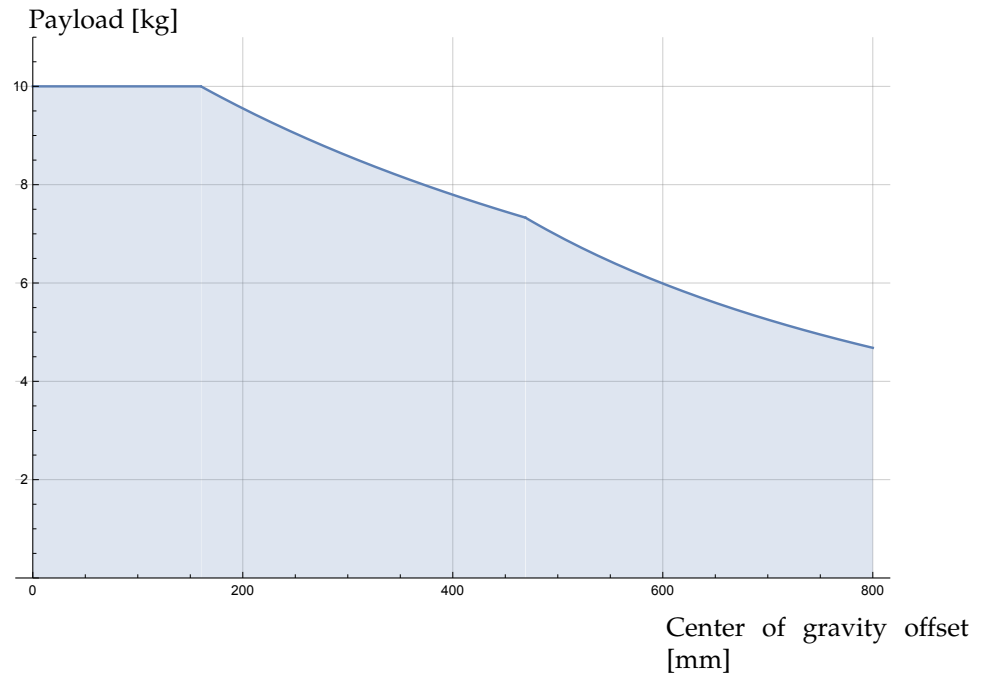

Figure 4.3: Relationship between the maximum allowed payload and the center of gravity offset.

5 Electrical Interface

5.1 Introduction

This chapter describes all the electrical interfaces of the robot arm and control box.

The different interfaces are divided into five groups with different purposes and properties:

- Controller I/O
- Tool I/O
- Ethernet
- Mains connection
- Robot connection

The term *I/O* refers both digital and analog control signals going from or to an interface.

Electrical signals through the E67 interface are described in part III.

These five groups are described in the following sections. Examples are given for most types of I/O.

The warnings and cautions in the following section are relevant for all five groups and must be observed.

5.2 Electrical warnings and cautions

The following warnings and cautions must be observed when a robot application is designed and installed. The warnings and cautions also apply for service work.



DANGER:

1. Never connect safety signals to a PLC which is not a safety PLC with the correct safety level. Failure to follow this warning could result in serious injury or death as the safety functions could be overridden. It is important to keep safety interface signals separated from the normal I/O interface signals.
2. All safety-related signals are constructed redundantly (Two independent channels). Keep the two channels separate so that a single fault cannot lead to loss of the safety function.
3. Some I/O inside the control box can be configured for either normal or safety-related I/O. Read and understand the complete section 5.3.

**DANGER:**

1. Make sure that all equipment not rated for water exposure remains dry. If water is allowed to enter the product, lockout and tagout all power and then contact your supplier.
2. Use original cables supplied with the robot only. Do not use the robot for applications where the cables will be subjected to flexing. Contact your supplier if longer or flexible cables are needed.
3. Negative connections are referred to as **GND** and are connected to the shield of the robot and the controller box. All mentioned **GND** connections are only for powering and signalling. For PE (Protective Earth) use the M6 sized screw connections marked with earth symbols inside the control box. The grounding conductor shall have at least the current rating of the highest current in the system.
4. Care must be taken when installing interface cables to the robot I/O. The metal plate in the bottom is intended for interface cables and connectors. Remove the plate before drilling the holes. Make sure that all shavings are removed before reinstalling the plate. Remember to use correct gland sizes.

**CAUTION:**

1. The robot has been tested according to international IEC standards for EMC (ElectroMagnetic Compatibility). Disturbing signals with levels higher than those defined in the specific IEC standards can cause unexpected behavior of the robot. Very high signal levels or excessive exposure can damage the robot permanently. EMC problems are found to happen usually in welding processes and are normally prompted by error messages in the log. Universal Robots cannot be held responsible for any damages caused by EMC problems.
2. I/O cables going from the control box to other machinery and factory equipment may not be longer than 30m, unless extended tests are performed.



NOTE:

All voltages and currents are in DC (Direct Current) unless otherwise specified.

5.3 Controller I/O

This chapter explains how to connect equipment to I/O inside the control box. This I/O is extremely flexible and can be used for wide range of different equipment; including pneumatic relays, PLCs and emergency stop buttons.

The illustration below shows the layout of electrical interface inside the control box.

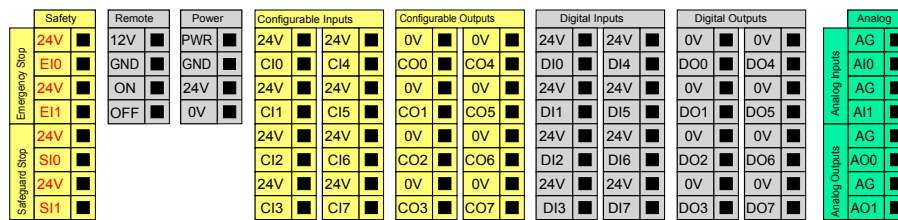

The meaning of the different colors must be observed, see below.

Yellow with red text	Dedicated safety signals
Yellow with black text	Configurable for safety
Gray with black text	General purpose digital I/O
Green with black text	General purpose analog I/O

The **configurable** I/O can be configured as either safety-related I/O or general purpose I/O in the GUI. See more in part II.

How to use the digital I/O is described in the following subsections. The section describing the common specifications must be observed.

5.3.1 Common specifications for all digital I/O

This section define electrical specifications for the following 24V digital I/O of the control box.

- Safety I/O.
- Configurable I/O.
- General purpose I/O.

It is very important that UR robots are installed according the electrical specifications, which are the same for all three different kinds of inputs.

It is possible to power the digital I/O from an internal 24V power supply or from an external power source by configuring the terminal block called **Power**. This block consists of four terminals. The

upper two (PWR and GND) are 24V and ground from the internal 24V supply. The lower two (24V and 0V) in the block are the 24V input to supply the I/O. The default configuration is to use the internal power supply, see below.

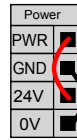

If more current is needed, an external power supply can be connected as shown below.

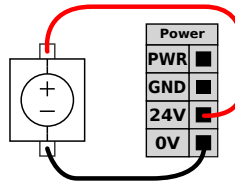

The electrical specifications for both the internal and an external power supply are shown below.

Terminals	Parameter	Min	Typ	Max	Unit
<i>Internal 24V power supply</i>					
[PWR - GND]	Voltage	23	24	25	V
[PWR - GND]	Current	0	-	2	A
<i>External 24V input requirements</i>					
[24V - 0V]	Voltage	20	24	29	V
[24V - 0V]	Current	0	-	6	A

The digital I/O are constructed in compliance with IEC 61131-2. The electrical specifications are shown below.

Terminals	Parameter	Min	Typ	Max	Unit
<i>Digital outputs</i>					
[COx / DOx]	Current*	0	-	1	A
[COx / DOx]	Voltage drop	0	-	0.5	V
[COx / DOx]	Leakage current	0	-	0.1	mA
[COx / DOx]	Function	-	PNP	-	Type
[COx / DOx]	IEC 61131-2	-	1A	-	Type
<i>Digital Inputs</i>					
[EIx/SIx/CIx/DIx]	Voltage	-3	-	30	V
[EIx/SIx/CIx/DIx]	OFF region	-3	-	5	V
[EIx/SIx/CIx/DIx]	ON region	11	-	30	V
[EIx/SIx/CIx/DIx]	Current (11-30V)	2	-	15	mA
[EIx/SIx/CIx/DIx]	Function	-	PNP	-	Type
[EIx/SIx/CIx/DIx]	IEC 61131-2	-	3	-	Type

Copyright © 2009–2019 by Universal Robots A/S. All rights reserved.

Note: *For resistive loads or inductive loads of maximum 1H.

**NOTE:**

The word **configurable** is used for I/O that can be configured as either safety-related I/O or normal I/O. These are the yellow terminals with black text.

5.3.2 Safety I/O

This section describes the dedicated safety inputs (Yellow terminal with red text) and the configurable I/O (Yellow terminals with black text) when configured as safety I/O. The common specifications in section 5.3.1 must be observed.

Safety devices and equipment must be installed according to the safety instructions and the risk assessment (see chapter 1).

All safety I/O are pairwise (redundant) and must be kept as two separate branches. A single fault shall not cause loss of the safety function.

The two permanent safety inputs are the Robot Emergency Stop and the Safeguard Stop. The Robot Emergency Stop input is for emergency stop equipment only. The Safeguard Stop input is for all kinds of safety-related protective equipment. The functional difference is shown below.

	Emergency Stop	Safeguard Stop
Robot stops moving	Yes	Yes
Program execution	Stops	Pauses
Robot power	Off	On
Reset	Manual	Automatic or manual
Frequency of use	Infrequent	Every cycle to infrequent
Requires re-initialization	Brake release only	No
Stop Category (IEC 60204-1)	1	2
Performance level of monitoring function (ISO 13849-1)	PLd	PLd

It is possible to use the configurable I/O to set up additional safety I/O functionality, e.g. emergency stop output. Configuring a set of configurable I/O for safety functions are done through the GUI, see part II.

Some examples of how to use safety I/O are shown in the following subsections.



DANGER:

1. Never connect safety signals to a PLC which is not a safety PLC with the correct safety level. Failure to follow this warning could result in serious injury or death as the safety functions could be overridden. It is important to keep safety interface signals separated from the normal I/O interface signals.
2. All safety-related I/O are constructed redundantly (Two independent channels). Keep the two channels separate so that a single fault cannot lead to loss of the safety function.
3. Safety functions must be verified before putting the robot into operation. Safety functions must be tested regularly.
4. The robot installation shall conform to these specifications. Failure to do so could result in serious injury or death as the safety function could be overridden.

5.3.2.1 Default safety configuration

The robot is shipped with a default configuration which enables operation without any additional safety equipment, see illustration below.



5.3.2.2 Connecting emergency stop buttons

In most applications it is required to use one or more extra emergency stop buttons. The illustration below shows how one or more emergency stop buttons can be connected.

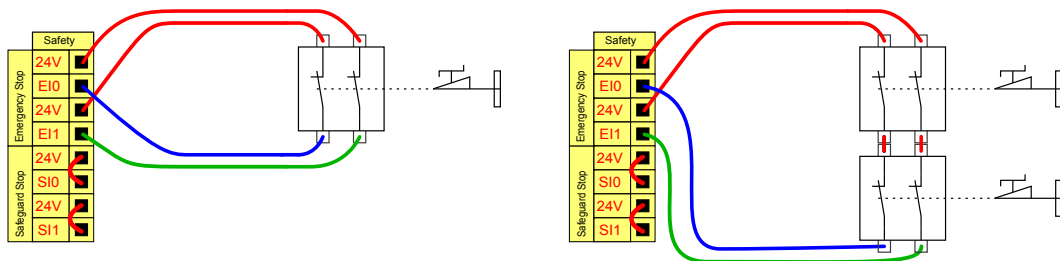

5.3.2.3 Sharing emergency stop with other machines

It is often desired to set up a common emergency stop circuit when the robot is used together with other machines. By doing so, the operator does not need to think about which emergency stop buttons to use.

5.3 Controller I/O

The Robot Emergency Stop input cannot be used for sharing purposes, since both machines will wait for the each other to go out of the emergency stopped condition.

In order to share the emergency stop function with other machinery, the following configurable I/O functions must be configured through the GUI.

- Configurable input pair: External emergency stop.
- Configurable output pair: System emergency stop.

The illustration below shows how two UR robots share their emergency stop functions. In this example the configured I/Os used are “CI0-CI1” and “CO0-CO1”.

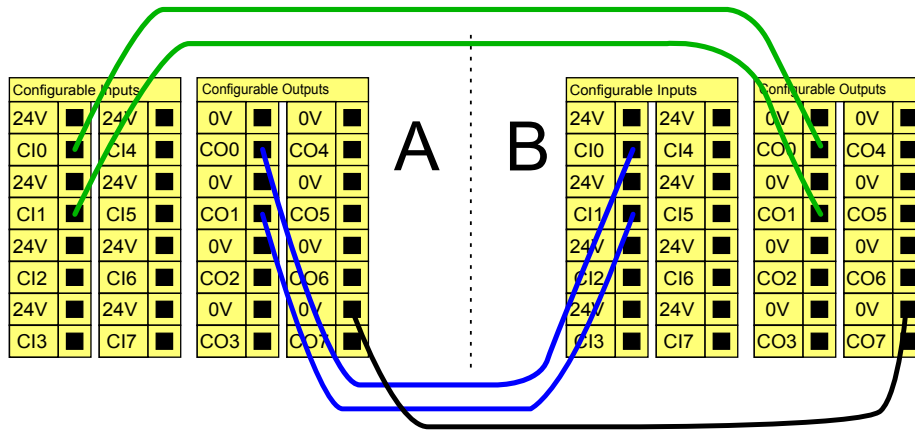

If more than two UR robots or other machines need to be connected, a safety PLC is needed to control the emergency stop signals.

5.3.2.4 Safeguard stop with automatic resume

An example of a basic safeguard stop device is a door switch where the robot is stopped when a door is opened, see illustration below.

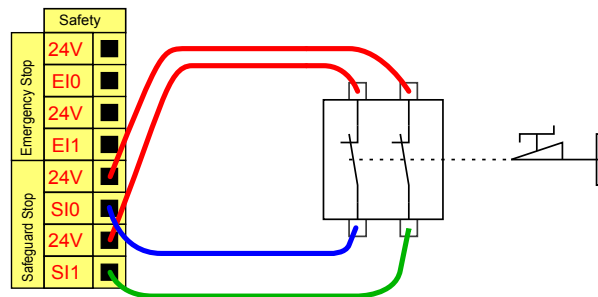

This configuration is only intended for application where the operator cannot pass the door and close it behind him. The configurable I/O can be used to setup a reset button outside the door, to reactivate robot motion.

Another example where automatic resume can be appropriate is when using a safety mat or a safety-related laser scanner, see below.

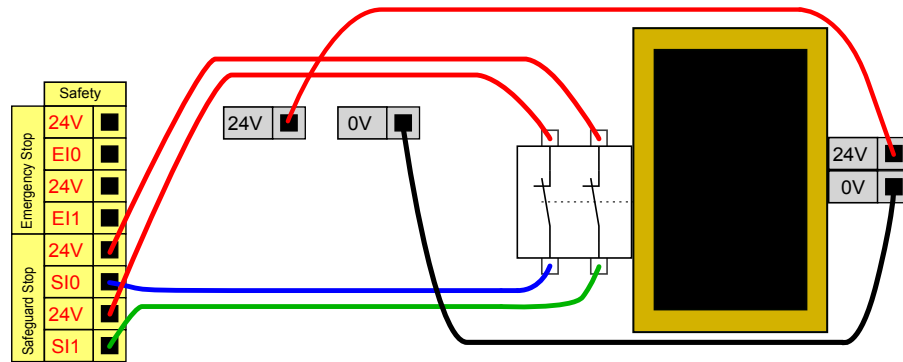

DANGER:

1. The robot resumes movement automatically when the safeguard signal is re-established. Do not use this configuration if signal can be re-established from the inside of the safety perimeter.

5.3.2.5 Safeguard stop with reset button

If the safeguard interface is used to interface a light curtain, a reset outside the safety perimeter is required. The reset button must be a two channel type. In this example the I/O configured for reset is "CI0-CI1", see below.

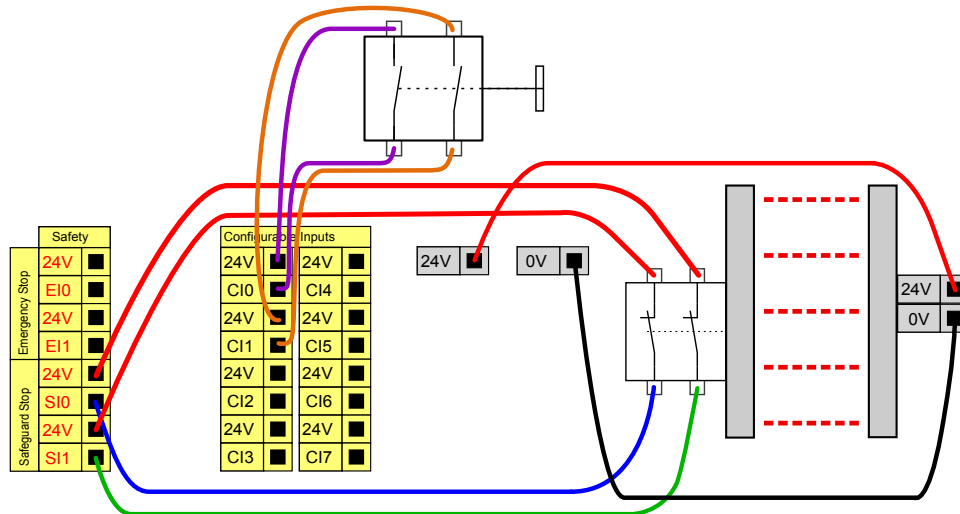

5.3.2.6 Three-Position Enabling Device

The illustration below shows how to connect a Three-Position Enabling Device. See section 10.13.1 for more about Three-Position Enabling Device.



NOTE:

The Universal Robots safety system does not support multiple Three-Position Enabling Devices.

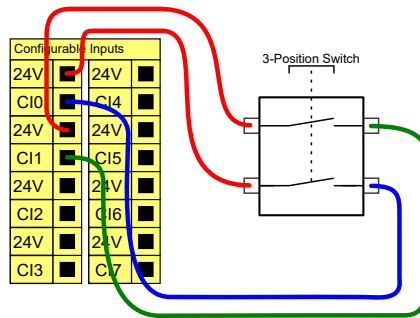

NOTE:

The two input channels for the Three-Position Enabling Device input have a disagreement tolerance of 1 second.

5.3.3 General purpose digital I/O

This section describes the general purpose 24V I/O (Gray terminals) and the configurable I/O (Yellow terminals with black text) when not configured as safety I/O. The common specifications in section 5.3.1 must be observed.

The general purpose I/O can be used to drive equipment like pneumatic relays directly or for communication with other PLC systems. All digital outputs can be disabled automatically when program execution is stopped, see more in part II. In this mode, the output is always low when a program is not running. Examples are shown in the following subsections. These examples use regular digital outputs but any configurable outputs could also have been used if they are not configured to perform a safety function.

5.3.3.1 Load controlled by a digital output

This example shows how to connect a load to be controlled from a digital output, see below.

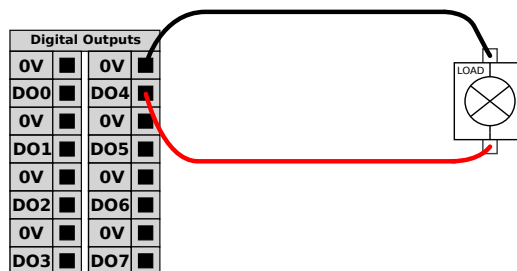

Copyright © 2009–2019 by Universal Robots A/S. All rights reserved.

5.3.4 Digital input from a button

The example below shows how to connect a simple button to a digital input.

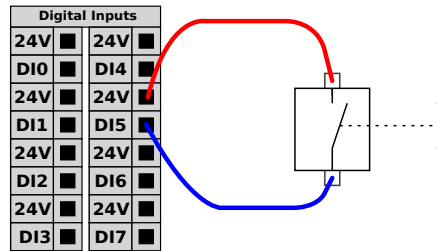

5.3.5 Communication with other machines or PLCs

The digital I/O can be used to communicate with other equipment if a common GND (0V) is established and if the machine uses PNP technology, see below.

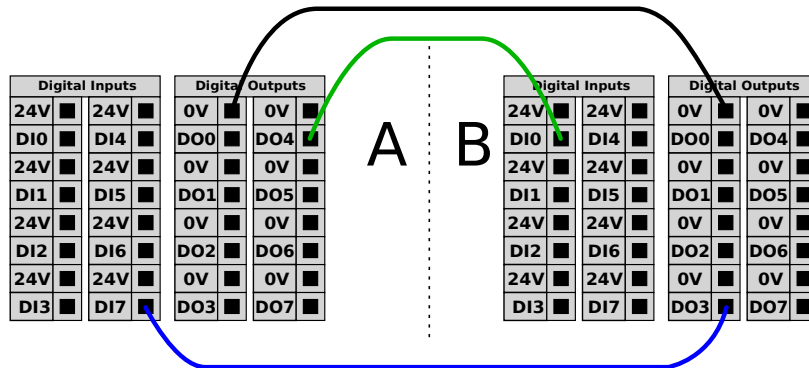

5.3.6 General purpose analog I/O

The analog I/O interface is the green terminal. It can be used to set or measure voltage (0-10V) or current (4-20mA) from and to other equipment.

The following is recommended to achieve the highest accuracy.

- Use the AG terminal closest to the I/O. The pair share a common mode filter.
- Use the same gnd (0V) for equipment and control box. The analog I/O is not galvanically isolated from the control box.
- Use a shielded cable or twisted pairs. Connect the shield to the “GND” terminal at the terminal called “Power”.
- Use of equipment that works in current mode. Current signals are less sensitive to interferences.

Input modes can be selected in the GUI, see part II. The electrical specifications are shown below.

5.3 Controller I/O

Terminals	Parameter	Min	Typ	Max	Unit
<i>Analog input in current mode</i>					
[AIx - AG]	Current	4	-	20	mA
[AIx - AG]	Resistance	-	20	-	ohm
[AIx - AG]	Resolution	-	12	-	bit
<i>Analog input in voltage mode</i>					
[AIx - AG]	Voltage	0	-	10	V
[AIx - AG]	Resistance	-	10	-	Kohm
[AIx - AG]	Resolution	-	12	-	bit
<i>Analog output in current mode</i>					
[AOx - AG]	Current	4	-	20	mA
[AOx - AG]	Voltage	0	-	24	V
[AOx - AG]	Resolution	-	12	-	bit
<i>Analog output in voltage mode</i>					
[AOx - AG]	Voltage	0	-	10	V
[AOx - AG]	Current	-20	-	20	mA
[AOx - AG]	Resistance	-	1	-	ohm
[AOx - AG]	Resolution	-	12	-	bit

The following examples show how to use the analog I/O.

5.3.6.1 Using an analog output

Below is an example of how to control a conveyor belt with an analog speed control input.

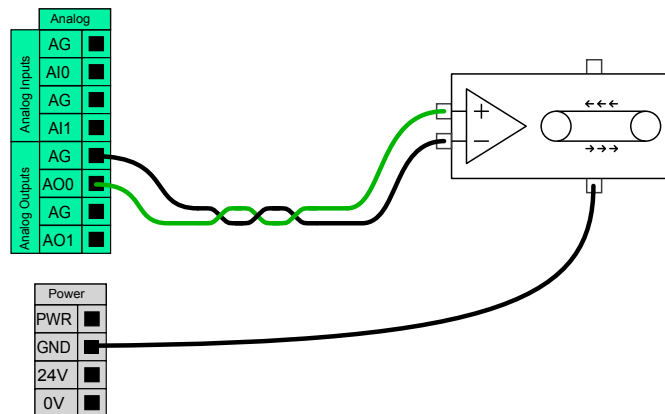

5.3.6.2 Using an Analog Input

Below is an example of how to connect an analog sensor.

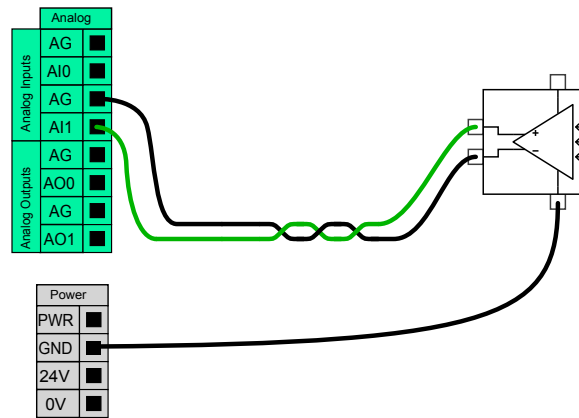

5.3.7 Remote ON/OFF control

Remote ON/OFF control can be used to turn the control box on and off without using the teach pendant. It is typically used in the following applications:

- When the teach pendant is inaccessible.
- When a PLC system must have full control.
- When several robots must be turned on or off at the same time.

The remote ON/OFF control provides a small auxiliary 12V supply, which is kept active when the controller box is turned off. The “on” and “off” inputs are intended for short time activation only. The “on” input works in the same way as the power button. Always use the “off” input for remote “off” control as this signal allows the control box to save open files and shut down correctly.

The electrical specifications are shown below.

Terminals	Parameter	Min	Typ	Max	Unit
[12V - GND]	Voltage	10	12	13	V
[12V - GND]	Current	-	-	100	mA
[ON / OFF]	Inactive voltage	0	-	0.5	V
[ON / OFF]	Active voltage	5	-	12	V
[ON / OFF]	Input current	-	1	-	mA
[ON]	Activation time	200	-	600	ms

The following examples show how to use remote ON/OFF.



NOTE:

A special feature in the software can be used to load and start programs automatically, see part II.



CAUTION:

1. Never use the “on” input or the power button to turn off the control box.

5.3.7.1 Remote ON button

The illustration below shows how to connect a remote on button.

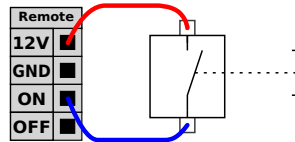

5.3.7.2 Remote OFF button

The illustration below shows how to connect a remote off button.

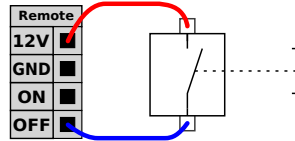

5.4 Tool I/O

At the tool end of the robot there is a small connector with eight pins, see illustration below.

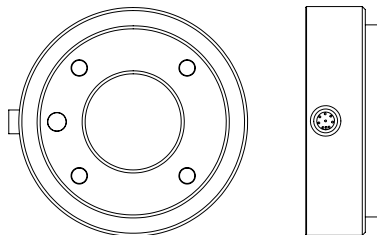

This connector provides power and control signals for grippers and sensors used on a specific robot tool. The following industrial cables are suitable:

- Lumberg RKMV 8-354.



NOTE:

The Tool Connector must be manually tightened up to a maximum of 0.4Nm.

The eight wires inside the cable have different colors. The different colors designate different functions, see table below:

Color	Signal
Red	0V (GND)
Gray	0V/+12V/+24V (POWER)
Blue	Tool output 0 (TO0)
Pink	Tool output 1 (TO1)
Yellow	Tool input 0 (TI0)
Green	Tool input 1 (TI1)
White	Analog input 2 (AI2)
Brown	Analog input 3 (AI3)

The internal power supply can be set to either 0V, 12V or 24V at the I/O tab the GUI, see part II. The electrical specifications are shown below:

Parameter	Min	Typ	Max	Unit
Supply voltage in 24V mode	-	24	-	V
Supply voltage in 12V mode	-	12	-	V
Supply current in both modes*	-	-	600	mA

Note: *It is highly recommended to use a protective diode for inductive loads

The following sections describe the different I/O's of the tool.



DANGER:

1. Connect tools and grippers such that an interruption of power does not create any hazards, e.g., a work-piece falling out of the tool.
2. Take care when using 12V, since an error made by the programmer can cause the voltage to change to 24V, which might damage the equipment and cause a fire.



NOTE:

The tool flange is connected to GND (same as the red wire).

5.4.1 Tool Digital Outputs

The digital outputs are implemented as NPN. When a digital output is activated the corresponding connection is driven to GND, and when it is deactivated the corresponding connection is open (open-collector/open-drain). The electrical specifications are shown below:

Parameter	Min	Typ	Max	Unit
Voltage when open	-0.5	-	26	V
Voltage when sinking 1A	-	0.05	0.20	V
Current when sinking	0	-	600	mA
Current through GND	0	-	600	mA

An example of how to use a digital output is shown in the following subsection.



CAUTION:

1. The digital outputs in the tool are not current limited and over-riding the specified data can cause permanent damage.

5.4.1.1 Using the Tool Digital Outputs

The example below illustrates how to turn on a load, when using the internal 12V or 24V power supply. Remember that you have to define the output voltage at the I/O tab. Keep in mind that there is voltage between the POWER connection and the shield/ground, even when the load is turned off.

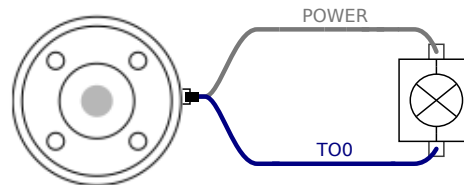

Note: It is highly recommended to use a protective diode for inductive loads, as shown below.

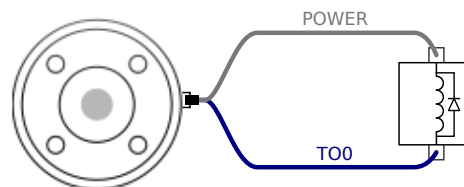

5.4.2 Tool Digital Inputs

The digital inputs are implemented as PNP with weak pull-down resistors. This means that a floating input will always read low. The electrical specifications are shown below.

Parameter	Min	Typ	Max	Unit
Input voltage	-0.5	-	26	V
Logical low voltage	-	-	2.0	V
Logical high voltage	5.5	-	-	V
Input resistance	-	47k	-	Ω

An example of how to use a digital input is shown in the following subsection.

5.4.2.1 Using the Tool Digital Inputs

The example below shows how to connect a simple button.

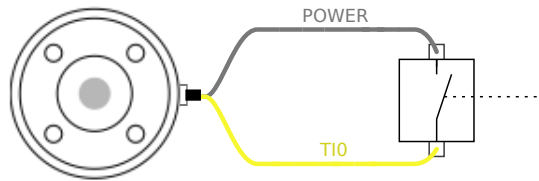

5.4.3 Tool Analog Inputs

The tool analog inputs are non-differential and can be set to either voltage and current on the I/O tab, see part II. The electrical specifications are shown below.

Parameter	Min	Typ	Max	Unit
Input voltage in voltage mode	-0.5	-	26	V
Input resistance @ range 0V to 10V	-	15	-	kΩ
Resolution	-	12	-	bit
Input voltage in current mode	-0.5	-	5.0	V
Input current in current mode	-2.5	-	25	mA
Input resistance @ range 4mA to 20mA	-	200	-	Ω
Resolution	-	12	-	bit

Two examples of how to use analog inputs are shown in the following subsections.



CAUTION:

1. Analog inputs are not protected against over voltage in current mode. Overrating the limit in the electrical specification can cause permanent damage to the input.

5.4.3.1 Using the Tool Analog Inputs, Non-differential

The example below shows how to connect an analog sensor with a non-differential output. The output of the sensor can be either current or voltage, as long as the input mode of that analog input is set to the same on the I/O tab. Remember to check that a sensor with voltage output can drive the internal resistance of the tool, or the measurement might be invalid.

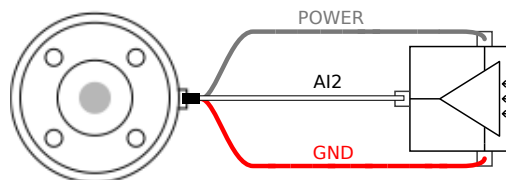

5.4.3.2 Using the Tool Analog Inputs, Differential

The example below shows how to connect an analog sensor with a differential output. Connect the negative output part to GND (0V) and it works in the same way as a non-differential sensor.

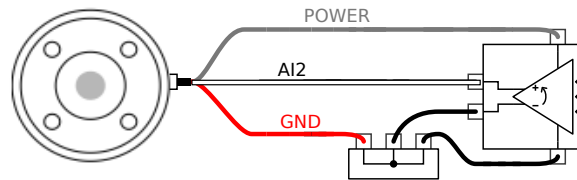

5.5 Ethernet

An Ethernet connection is provided at the bottom of the control box, see illustration below.

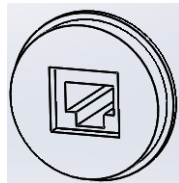

The Ethernet interface can be used for the following:

- MODBUS I/O expansion modules. See more in part II.
- Remote access and control.

The electrical specifications are shown below.

Parameter	Min	Typ	Max	Unit
Communication speed	10	-	1000	Mb/s

5.6 Mains connection

The mains cable from the controller box has a standard IEC plug in the end. Connect a country specific mains plug or cable to the IEC plug.

In order to energize the robot, the control box must be connected to the mains. This must be done through the standard IEC C20 plug at the bottom of the control box through a corresponding IEC C19 cord, see illustration below.

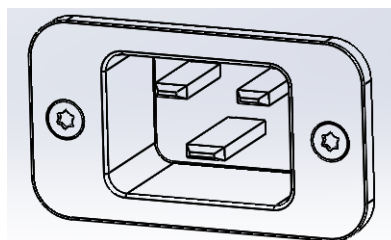

The mains supply shall be equipped with the following as a minimum:

- Connection to earth.
- Main fuse.
- Residual current device.

It is recommended to install a main switch to power off all equipment in the robot application as an easy means for lockout and tagout under service.

The electrical specifications are shown in the table below.

Parameter	Min	Typ	Max	Unit
Input voltage	100	-	265	VAC
External mains fuse (@ 100-200V)	15	-	16	A
External mains fuse (@ 200-265V)	8	-	16	A
Input frequency	47	-	63	Hz
Stand-by power	-	-	0.5	W
Nominal operating power	90	250	500	W

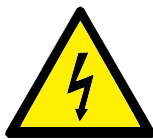

DANGER:

1. Make sure that the robot is grounded correctly (Electrical connection to earth). Use the unused bolts associated with grounding symbols inside the controller box to create common grounding of all equipment in the system. The grounding conductor shall have at least the current rating of the highest current in the system.
2. Make sure that the input power to the controller box is protected with a RCD (Residual Current Device) and a correct fuse.
3. Lockout and tagout all power for the complete robot installation during service. Other equipment shall not supply voltage to the robot I/O when the system is locked out.
4. Make sure that all cables are connected correctly before the controller box is powered. Always use an original and correct power cord.

5.7 Robot connection

The cable from the robot must be plugged into the connector at the bottom of the control box, see illustration below. Ensure that the connector is properly locked before turning on the robot arm. Disconnecting the robot cable may only be done when the robot power is turned off.

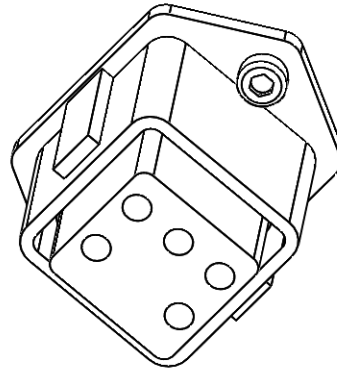

CAUTION:

1. Do not disconnect the robot cable when the robot arm is turned on.
2. Do not extend or modify the original cable.

Copyright © 2009–2019 by Universal Robots A/S. All rights reserved.

6 Maintenance and Repair

You must perform maintenance and repair work in compliance with all safety instructions in this manual.

You must perform maintenance, calibration and repair work according to the latest versions of Service Manuals on the support website <http://www.universal-robots.com/support>.

Only authorized system integrators, or Universal Robots, shall perform repairs.

All parts returned to Universal Robots shall be returned according to the service manual.

6.1 Safety Instructions

After maintenance and repair work, checks must be done to ensure the required safety level. Checks must adhere to valid national or regional work safety regulations. The correct functioning of all safety functions shall also be tested.

The purpose of maintenance and repair work is to ensure that the system is kept operational or, in the event of a fault, to return the system to an operational state. Repair work includes troubleshooting in addition to the actual repair itself.

When working on the robot arm or control box, you must observe the procedures and warnings below.



DANGER:

1. Do not change anything in the safety configuration of the software (e.g. the force limit). The safety configuration is described in the PolyScope Manual. If any safety parameter is changed, the complete robot system shall be considered new, meaning that the overall safety approval process, including risk assessment, shall be updated accordingly.
2. Replace faulty components using new components with the same article numbers or equivalent components approved by Universal Robots for this purpose.
3. Reactivate any deactivated safety measures immediately after the work is completed.
4. Document all repairs and save this documentation in the technical file associated with the complete robot system.



DANGER:

1. Remove the mains input cable from the bottom of the control box to ensure that it is completely unpowered. Deenergize any other source of energy connected to the robot arm or control box. Take necessary precautions to prevent other persons from energizing the system during the repair period.
2. Check the earth connection before re-powering the system.
3. Observe ESD regulations when parts of the robot arm or control box are disassembled.
4. Avoid disassembling the power supplies inside the control box. High voltages (up to 600 V) can be present inside these power supplies for several hours after the control box has been switched off.
5. Prevent water and dust from entering the robot arm or control box.

7 Disposal and Environment

UR robots must be disposed of in accordance with the applicable national laws, regulations and standards.

UR robots are produced with restricted use of hazardous substances to protect the environment; as defined by the European RoHS directive 2011/65/EU. These substances include mercury, cadmium, lead, chromium VI, polybrominated biphenyls and polybrominated diphenyl ethers.

Fee for disposal and handling of electronic waste of UR robots sold on the Danish market is prepaid to DPA-system by Universal Robots A/S. Importers in countries covered by the European WEEE Directive 2012/19/EU must make their own registration to the national WEEE register of their country. The fee is typically less than 1€/robot. A list of national registers can be found here: <https://www.ewrn.org/national-registers>.

The following symbols are affixed on the robot to indicate conformity with the above legislations:

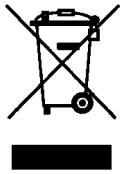

8 Certifications

This chapter presents certificates and declarations prepared for e-Series robots with the standard control box.

8.1 Third Party Certification

Third party certification is voluntary. However, to provide the best service to robot integrators, UR chooses to certify our robots at the following recognized test institutes:



TÜV NORD UR robots are safety approved by TÜV NORD, a notified body under the machinery directive 2006/42/EC in EU. You can find a copy of the TÜV NORD safety approval certificate in appendix B.



TÜV Rheinland UR robots are safety approved by TÜV Rheinland a notified body under the machinery directive 2006/42/EC in EU. You can find a copy of the TÜV Rheinland certificate in appendix B.



DELTA UR robots are performance tested by DELTA. You can find electromagnetic compatibility (EMC) and environmental test certificates in appendix B.



TÜV SÜD UR robots are cleanroom tested by TÜV SÜD. You can find a cleanroom certificate in appendix B.



CHINA RoHS UR robots conform to CHINA RoHS management methods for controlling pollution by electronic information products. You can find a copy of the Product Declaration Table in appendix B



KCC Safety UR robots conform to Korea KC Mark Certification standards for product safety. You can find a copy of the KCC Safety certificate in appendix B

8.2 Supplier Third Party Certification



Environment As provided by our suppliers, UR robots shipping pallets comply with the ISPM-15 Danish requirements for producing wood packaging material and are marked in accordance with this scheme.

8.3 Manufacturer Test Certification



UR UR robots undergo continuous internal testing and end of line test procedures. UR testing processes undergo continuous review and improvement.

8.4 Declarations According to EU directives

Although they are primarily relevant for Europe, some countries outside Europe recognize and/or require **EU declarations**. European directives are available on the official homepage: <http://eur-lex.europa.eu>.

UR robots are certified according to the directives listed below.

2006/42/EC — Machinery Directive (MD)

According to the Machinery Directive 2006/42/EC, UR robots are **partly completed machinery**, as such a **CE** mark is not affixed.

Note: If the UR robot is used in a pesticide application, you must note the presence of directive 2009/127/EC. The declaration of incorporation according to 2006/42/EC annex II 1.B. is shown in appendix B.

2006/95/EC — Low Voltage Directive (LVD)

2004/108/EC — Electromagnetic Compatibility (EMC)

2011/65/EU — Restriction of the use of certain Hazardous Substances (RoHS)

2012/19/EU — Waste of Electrical and Electronic Equipment (WEEE)

In the Declaration of Incorporation in appendix B, declarations of conformity with the above directives are listed.

A **CE** mark is affixed according to the **CE** marking directives above. Information on both electric and electronic equipment waste is in chapter 7.

Information on standards applied during the development of the robot is in appendix C.

9 Warranties

9.1 Product Warranty

Without prejudice to any claim the user (customer) may have in relation to the dealer or retailer, the customer shall be granted a manufacturer's Warranty under the conditions set out below:

In the case of new devices and their components exhibiting defects resulting from manufacturing and/or material faults within 12 months of entry into service (maximum of 15 months from shipment), Universal Robots shall provide the necessary spare parts, while the user (customer) shall provide working hours to replace the spare parts, either replace the part with another part reflecting the current state of the art, or repair the said part. This Warranty shall be invalid if the device defect is attributable to improper treatment and/or failure to comply with information contained in the user guides. This Warranty shall not apply to or extend to services performed by the authorized dealer or the customer themselves (e.g. installation, configuration, software downloads). The purchase receipt, together with the date of purchase, shall be required as evidence for invoking the Warranty. Claims under the Warranty must be submitted within two months of the Warranty default becoming evident. Ownership of devices or components replaced by and returned to Universal Robots shall vest in Universal Robots. Any other claims resulting out of or in connection with the device shall be excluded from this Warranty. Nothing in this Warranty shall attempt to limit or exclude a Customer's Statutory Rights nor the manufacturer's liability for death or personal injury resulting from its negligence. The duration of the Warranty shall not be extended by services rendered under the terms of the Warranty. Insofar as no Warranty default exists, Universal Robots reserves the right to charge the customer for replacement or repair. The above provisions do not imply a change in the burden of proof to the detriment of the customer. In case of a device exhibiting defects, Universal Robots shall not be liable for any indirect, incidental, special or consequential damages, including but not limited to, lost profits, loss of use, loss of production or damage to other production equipment.

In case of a device exhibiting defects, Universal Robots shall not cover any consequential damage or loss, such as loss of production or damage to other production equipment.



CAUTION:

It is generally advised to avoid the use of accelerations higher than needed for a given application. High accelerations, especially in combination with high loads, can lead to reduced life time of the robot. For applications with short cycle times and high requirements for speed, it is generally advised to use blends as much as possible to ensure smooth trajectories without the need for high accelerations.

9.2 Disclaimer

Universal Robots continues to improve reliability and performance of its products, and therefore reserves the right to upgrade the product without prior warning. Universal Robots takes every care that the contents of this manual are precise and correct, but takes no responsibility for any errors or missing information.

A Stopping Time and Stopping Distance

The information about stopping times and distances is available for both Stop Category 0 and Stop Category¹ 1. This appendix includes the information regarding Stop Category 0. Information on Stop Category 1 is available on <http://universal-robots.com/support/>.

A.1 Stop Category 0 stopping distances and times

The table below includes the stopping distances and times measured when a Stop Category 0 is triggered. These measurements correspond to the following configuration of the robot:

- Extension: 100% (the robot arm is fully extended horizontally).
- Speed: 100% (the general speed of the robot is set to 100% and the movement is performed at a joint speed of 183 °/s).
- Payload: maximum payload handled by the robot attached to the TCP (10 kg).

The test on the Joint 0 was carried out by performing a horizontal movement, i.e. the axis of rotation was perpendicular to the ground. During the tests for Joint 1 and 2 the robot followed a vertical trajectory, i.e. the axes of rotation were parallel to the ground, and the stop was performed while the robot was moving downwards.

	Stopping Distance (rad)	Stopping time (ms)
Joint 0 (BASE)	0.98	750
Joint 1 (SHOULDER)	0.35	240
Joint 2 (ELBOW)	0.38	280

¹According to IEC 60204-1, see Glossary for more details.

B Declarations and Certificates

B.1 EU Declaration of Incorporation in accordance with ISO/IEC 17050-1:2010

Manufacturer:		Person in the Community Authorized to Compile the Technical File:
	Universal Robots A/S Energivej 25 DK-5260 Odense S Denmark	David Brandt Technology Officer, R&D Universal Robots A/S Energivej 25, DK-5260 Odense S
Description and Identification of the Partially-Completed Machine(s):		
	Product and Function:	Industrial robot (multi-axis manipulator with Control Box and Teach Pendant). Function is determined by the completed machine (with end-effector and intended use).
	Model:	UR3, UR5, UR10 with CB3 control box (UR3/CB3, UR5/CB3, UR10/CB3)
	Serial Number:	Starting 20183000000 and higher — Effective 1 January 2018
	Incorporation:	Universal Robots (UR3, UR5, and UR10) shall only be put into service upon being integrated into a final complete machine (robot system, cell or application), which conforms with the provisions of the Machinery Directive and other applicable Directives.

It is declared that the above products, for what is supplied, fulfil the following Directives as Detailed Below:

- I **Machinery Directive 2006/42/EC** — The following essential requirements have been fulfilled: 1.1.2, 1.1.3, 1.1.5, 1.2.1, 1.2.4.3, 1.2.6, 1.3.4, 1.3.8.1, 1.5.1, 1.5.2, 1.5.6, 1.5.10, 1.6.3, 1.7.2, 1.7.4, 4.1.2.3 It is declared that the relevant technical documentation has been compiled in accordance with Part B of Annex VII of the Machinery Directive.
- II **Low-voltage Directive 2014/35/EU** — Reference the LVD and the harmonized standards used below.
- III **EMC Directive 2014/30/EU** — Reference the EMC Directive and the harmonized standards used below.
- IV **RoHS Directive 2011/65/EU** — Reference the RoHS Directive 2011/65/EU
- V **WEEE Directive 2012/19/EU** — Reference th WEEE Directive 2012/19/EU



UNIVERSAL ROBOTS B.1 EU Declaration of Incorporation in accordance with ISO/IEC 17050-1:2010

Reference to Harmonized Standards Used:		
(I) EN ISO 10218-1:2011 as applicable (I) EN ISO 12100:2010 (I) EN ISO 13732-1:2008 (I) EN ISO 13849-1:2008 & 2015* *Note: From the 2008 to the 2015 editions, there are no changes relevant to our robots TUV Nord Certificate 4478014097602	(I) EN ISO 13849-2:2012 (I) EN ISO 13850:2015 (I) EN 1037:1995+A1:2008 (II) EN 60204-1:2006/ A1:2010 (I) EN ISO 13850:2015 (II) EN 60320-1:2001/ A1:2007 (II) EN 60529:1991/ A2:2013	(II) EN 60664-1:2007 (II) EN 60947-5-5:1997/ A11:2013 (II) EN 61000-6-2:2005 (III) EN 61000-6-4:2007/ A1:2011 (III) EN 61131-2:2007 (II) EN 61140:2002/ A1:2006
Reference to Other Technical Standards and Specifications Used:		
(I) ISO/TS 15066 as applicable (III) IEC 60068-2-1:2007 (III) IEC 60068-2-2:2007	(III) IEC 60068-2-27:2008 (III) IEC 60068-2-64:2008 (II) IEC 60664-5:2007 (III) IEC 61326-3-1:2008	(II) IEC 61784-3:2010 [SIL2] ISO 14664-1:2015 Class 5 for control assembly with enclosure and Class 5 for UR3, UR5 and UR10 manipulators
<p>The manufacturer, or his authorised representative, shall transmit relevant information about the partly completed machinery in response to a reasoned request by the national authorities.</p> <p>Approval of full quality assurance system (ISO 9001), by the notified body Bureau Veritas, certificate #DK008850.</p>		

Odense Denmark, 27 September 2018

Name:

Roberta Nelson Shea

Position/ Title

Global Technical Compliance Officer

Universal Robots A/S, Energivej 25, DK-5260 Odense S, Denmark
CVR-nr. 29 13 80 60

Phone +45 8993 8989
Fax +45 3879 8989

info@universal-robots.com
www.universal-robots.com

Copyright © 2009–2019 by Universal Robots A/S. All rights reserved.

B.2 Safety System Certificate



ZERTIFIKAT CERTIFICATE

Hiermit wird bescheinigt, dass die Firma / *This certifies, that the company*

Universal Robots A/S
Energivej 25
DK-5260 Odense S
Denmark

berechtigt ist, das unten genannte Produkt mit dem abgebildeten Zeichen zu kennzeichnen.
is authorized to provide the product mentioned below with the mark as illustrated.

Fertigungsstätte: <i>Manufacturing plant:</i>	Universal Robots A/S Energivej 25 DK-5260 Odense S Denmark	
Beschreibung des Produktes: <i>(Details s. Anlage 1) Description of product: (Details see Annex 1)</i>	Universal Robots Safety System URSafety 3.1 for UR10, UR5 and UR3 robots	

Geprüft nach: **EN ISO 13849-1:2008, PL d**
Tested in accordance with:

Registrier-Nr. / <i>Registration No.</i> 44 207 14097602 Prüfbericht Nr. / <i>Test Report No.</i> 3515 4327 Aktenzeichen / <i>File reference</i> 8000443298	Gültigkeit / <i>Validity</i> von / <i>from</i> 2015-06-02 bis / <i>until</i> 2020-06-01
---	---

Zertifizierungsstelle der TÜV NORD CERT GmbH
TÜV NORD CERT GmbH Langemarckstraße 20 45141 Essen Essen, 2015-06-02
www.tuev-nord-cert.de technology@tuev-nord.de

Bitte beachten Sie auch die umseitigen Hinweise
Please also pay attention to the information stated overleaf

Copyright © 2009–2019 by Universal Robots A/S. All rights reserved.

B.3 TUV Rheinland

<h1>Certificate</h1>		
Certificate no.		T 72190266 01
License Holder: Universal Robots A/S Energivej 25 5260 Odense S Denmark	Manufacturing Plant: Universal Robots A/S Energivej 25 5260 Odense S Denmark	
Test report no.: USA-RB 31875333 002	Client Reference: Roberta Nelson Shea	
Tested to: EN ISO 10218-1:2011		
Certified Product: Robot Manipulator and Controller	License Fee - Units	
Model Designation: UR3, UR5, UR10	7	
Rated Voltage: AC 100-200V, 47-63Hz or AC 200-240V, 47-63Hz		
Rated Current: 15A or 8A		
Protection Class: I		
Special Remarks: Solely assessed per standard listed above. The robot is only a component in a final robot application, collaborative or non-collaborative. The final application must comply with EN ISO 10218-2 accordingly. Replaces Certificate T7218250.		
Appendix: 1, 1-5	7	
Licensed Test mark:	Date of Issue (day/mo/yr) 01/02/2019	
 EN ISO 10218-1 www.tuv.com ID 0007000000		
<small>TUV Rheinland of North America, Inc., 12 Commerce Road, Newtown, CT 06470, Tel (203) 426-0888 Fax (203) 426-4009</small>		

Copyright © 2009–2019 by Universal Robots A/S. All rights reserved.

B.4 China RoHS

**Management Methods for Controlling Pollution
by Electronic Information Products
Product Declaration Table
For Toxic or Hazardous Substances**
表1 有毒有害物质或元素名称及含量标识格式



Product/Part Name 产品/部件名称	Toxic and Hazardous Substances and Elements 有毒有害物质或元素					
	铅 Lead (Pb)	汞 Mercury (Hg)	镉 Cadmium (Cd)	六价 Hexavalent Chromium (Cr+6)	多溴联苯 Polybrominated biphenyls (PBB)	多溴二苯醚 Polybrominated diphenyl ethers (PBDE)
UR Robots UR3 / UR5 / UR10 UR机器人 UR3/UR5/UR10	X	O	X	O	X	X

O: Indicates that this toxic or hazardous substance contained in all of the homogeneous materials for this part is below the limit requirement in SJ/T11363-2006.
O: 表示该有毒有害物质在该部件所有均质材料中的含量均在SJ/T 11363-2006规定的限量要求以下。

X: Indicates that this toxic or hazardous substance contained in at least one of the homogeneous materials used for this part is above the limit requirement in SJ/T11363-2006.
X: 表示该有毒有害物质至少在该部件的某一均质材料中的含量超出SJ/T 11363-2006规定的限量要求。
(企业可在此处，根据实际情况对上表中打“X”的技术原因进行进一步说明。)

Items below are wear-out items and therefore can have useful lives less than environmental use period:
下列项目是损耗品,因而它们的使用寿命可能短于环境使用时间:
Drives, Gaskets, Probes, Filters, Pins, Cables, Stiffener, Interfaces
驱动器, 垫圈, 探针, 过滤器, 别针, 缆绳, 加强筋, 接口

Refer to product manual for detailed conditions of use.
详细使用情况请阅读产品手册。

Universal Robots encourages that all Electronic Information Products be recycled but does not assume responsibility or liability.
Universal Robots 鼓励回收再利用所有的电子信息产品,但 Universal Robots 不负任何责任或义务

To the maximum extent permitted by law, Customer shall be solely responsible for complying with, and shall otherwise assume all liabilities that may be imposed in connection with, any legal requirements adopted by any governmental authority related to the Management Methods for Controlling Pollution by Electronic Information Products (Ministry of Information Industry Order #39) of the Peoples Republic of China otherwise encouraging the recycle and use of electronic information products. Customer shall defend, indemnify and hold Universal Robots harmless from any damage, claim or liability relating thereto. At the time Customer desires to dispose of the Products, Customer shall refer to and comply with the specific waste management instructions and options set forth at <http://www.teradyne.com/about-teradyne/corporate-social-responsibility>, as the same may be amended by Teradyne or Universal Robots.

Copyright © 2009–2019 by Universal Robots A/S. All rights reserved.

B.5 KCC Safety



자율안전확인 신고증명서

신청인	사업장명	Universal Robots A/S	사업장관리번호	2016E110079
	사업자등록번호	016E110079	대표자 성명	Klaus Vestergaard
	소재지	Energivej 25, 5260 Odense S, Denmark		
자율안전인증대상 기계		기구명	산업용로봇	
형식(규격)	UR10	용량(등급)	6 axis	
자율안전 확인번호	16-AB2EQ-00924			
제조사	Universal Robots A/S			
소재지	Energivej 25, 5260 Odense S, Denmark			

「산업안전보건법」 제35조제1항 및 같은 법 시행규칙 제61조제3항에 따라
자율안전확인 신고증명서를 발급합니다.

2018년 11월 06일

한국산업안전보건공단 서울지역본부장



Copyright © 2009–2019 by Universal Robots A/S. All rights reserved.

B.6 Environmental Test Certificate

Climatic and mechanical assessment



Client Universal Robots A/S Energivej 25 5260 Odense S Denmark	Force Technology project no. 117-32120
Product identification UR 3 robot arms UR 3 control boxes with attached Teach Pendants. UR 5 robot arms UR5 control boxes with attached Teach Pendants. UR10 robot arms: UR10 control boxes with attached Teach Pendants. See reports for details.	
Force Technology report(s) DELTA project no. 117-28266, DANAK-19/18069 DELTA project no. 117-28086, DANAK-19/17068	
Other document(s)	
Conclusion The three robot arms UR3, UR5 and UR10 including their control boxes and Teach Pendants have been tested according to the below listed standards. The test results are given in the Force Technology reports listed above. The tests were carried out as specified and the test criteria for environmental tests were fulfilled in general terms with only a few minor issues (see test reports for details). IEC 60068-2-1, Test Ae; -5 °C, 16 h IEC 60068-2-2, Test Be; +35°C, 16h IEC 60068-2-2, Test Be; +50°C, 16 h IEC 60068-2-64, Test Fh; 5 – 10 Hz: +12 dB/octave, 10-50 Hz 0.00042 g ² /Hz, 50 – 100 Hz: -12 dB/octave, 1,66 grms, 3 x 1½ h IEC 60068-2-27, Test Ea, Shock; 11 g, 11 ms, 3 x 18 shocks	
Date Hørsholm, 25 August 2017	Assessor  Andreas Wendelboe Højsgaard M.Sc.Eng.

DELTA – a part of FORCE Technology - Venlighedsvej 4 - 2970 Hørsholm - Denmark - Tel. +45 72 19 40 00 - Fax +45 72 19 40 01 - www.delta.dk

Copyright © 2009–2019 by Universal Robots A/S. All rights reserved.

B.7 EMC Test Certificate



We help ideas meet the real world

Attestation of Conformity

EMC assessment - Certificate no. 1549

DELTA has been designated as Notified Body by the notified authority National Telecom Administration part of the Energy Agency in Denmark to carry out tasks referred to in Annex III of the European Council EMC Directive. The attestation of conformity is in accordance with the essential requirements set out in Annex I.

DELTA client
Universal Robots A/S
Energivej 25
5260 Odense S
Denmark

Product identification (type(s), serial no(s).)
UR robot generation 3, G3, including CB3/AE for models UR3, UR5 and UR10

Manufacturer
Universal Robots A/S

Technical report(s)
DELTA Project T207371, EMC Test of UR5 and UR10 - DANAK-19/13884, dated 26 March 2014
DELTA Project T209172, EMC Test of UR3 - DANAK-19/14667, dated 05 November 2014
UR EMC Test Specification G3 rev 3, dated 30 October 2014
EMC Assessment Sheet 1351

Standards/Normative documents
EMC Directive 2014/30/EU, Article 6
EN/(IEC) 61326-3-1:2008, Industrial locations, SIL 2 applications
EN/(IEC) 61000-6-2:2005
EN/(IEC) 61000-6-4:2007+A1

DELTA
Venighedsvej 4
2970 Hørsholm
Denmark

The product identified above has been assessed and complies with the specified standards/normative documents. The attestation does not include any market surveillance. It is the responsibility of the manufacturer that mass-produced apparatus have the same EMC quality. The attestation does not contain any statements pertaining to the EMC protection requirements pursuant to other laws and/or directives other than the above mentioned if any.

Tel. +45 72 19 40 00
Fax +45 72 19 40 01
www.delta.dk
VAT No. 12275110

Hørsholm, 08 August 2016



Knud A. Baltsen
Senior Consultant

20aocass-uk-j

B.8 Cleanroom Test Certificates

ZERTIFIKAT ♦ CERTIFICATE ♦ CERTIFICADO ♦ CERTIFICAT



Industrie Service

CERTIFICATE

TÜV SÜD Industrie Service GmbH hereby confirms UNIVERSAL ROBOTS A/S situated at Energivej 25, 5260 Odense S; Dänemark, that the product

Roboter, Model: UR10 / Typ INDUSTRIAL

the cleanroom compatibility of the equipment for the ISO Class 5 according ISO 14644-1.

The certificate is limited to the particulate cleanliness. The product was tested according to VDI 2083 Part 9.1 in August 2016.

The implementation of the testing and certification is carried out by TÜV SÜD Industrie Service GmbH.

Certificate Nr.: 2589737-03
Report-Nr.: 203195-3
Valid till: August 2018

Dipl.-Ing. (FH) Walter Ritz
Berlin, 25. August 2016
TÜV SÜD Industrie Service GmbH
Wittestraße 30, Haus L, 13509 Berlin

Copyright © 2009–2019 by Universal Robots A/S. All rights reserved.



Industrie Service

ZERTIFIKAT ♦ CERTIFICATE ♦ CERTIFICADO ♦ CERTIFICAT

CERTIFICATE

TÜV SÜD Industrie Service GmbH hereby confirms UNIVERSAL ROBOTS A/S situated at Energivej 25, 5260 Odense S; Dänemark, that the product

Controller for UR 3 & UR 5 & UR 10

the cleanroom compatibility of the equipment for the ISO Class 6 according ISO 14644-1.

The certificate is limited to the particulate cleanliness. The product was tested according to VDI 2083 Part 9.1 in August 2016.

The implementation of the testing and certification is carried out by TÜV SÜD Industrie Service GmbH.

Certificate Nr.: 2589737-04
Report-Nr.: 203195
Valid till: August 2018

A handwritten signature in blue ink, appearing to read 'W. Ritz'.

Dipl.-Ing. (FH) Walter Ritz
Berlin, 25. August 2016
TÜV SÜD Industrie Service GmbH
Wittestraße 30, Haus L, 13509 Berlin

C Applied Standards

This section describes relevant standards applied under the development of the robot arm and control box. Whenever a European Directive number is noted in brackets, it indicates that the standard is harmonized according to that Directive.

A standard is not a law. A standard is a document developed by stakeholders within a given industry, defining the normal safety and performance requirements for a product or product group.

Abbreviations mean the following:

ISO	International Standardization Organization
IEC	International Electrotechnical Commission
EN	European Norm
TS	Technical Specification
TR	Technical Report
ANSI	American National Standards Institute
RIA	Robotic Industries Association
CSA	Canadian Standards Association

Conformity with the following standards is only guaranteed if all assembly instructions, safety instructions and guidance in this manual are followed.

ISO 13849-1:2006 [PLd]

ISO 13849-1:2015 [PLd]

ISO 13849-2:2012

EN ISO 13849-1:2008 (E) [PLd – 2006/42/EC]

EN ISO 13849-2:2012 (E) (2006/42/EC)

Safety of machinery – Safety-related parts of control systems

Part 1: General principles for design

Part 2: Validation

The safety control system is designed as Performance Level d (PLd) according to the requirements of these standards.

ISO 13850:2006 [Stop Category 1]
ISO 13850:2015 [Stop Category 1]
EN ISO 13850:2008 (E) [Stop Category 1 - 2006/42/EC]
EN ISO 13850:2015 [Stop Category 1 - 2006/42/EC]

Safety of machinery – Emergency stop – Principles for design

The emergency stop function is designed as a Stop Category 1 according to this standard. Stop Category 1 is a controlled stop with power to the motors to achieve the stop and then removal of power when the stop is achieved.

ISO 12100:2010
EN ISO 12100:2010 (E) [2006/42/EC]

Safety of machinery – General principles for design – Risk assessment and risk reduction

UR robots are evaluated according to the principles of this standard.

ISO 10218-1:2011
EN ISO 10218-1:2011(E) [2006/42/EC]

Robots and robotic devices – Safety requirements for industrial robots

Part 1: Robots

This standard is intended for the robot manufacturer, not the integrator. The second part (ISO 10218-2) is intended for the robot integrator, as it deals with the installation and design of the robot application.

The writers of the standard implicitly envisioned traditional industrial robots, which are traditionally safeguarded by fences and light curtains. UR robots are designed with force and power limiting enabled at all times. Therefore, some concepts are clarified and explained below.

If a UR robot is used in a hazardous application, additional safety measures might be required, see chapter 1 of this manual.

Clarification:

- “3.24.3 Safeguarded space” is defined by the perimeter safeguarding. Typically, the safeguarded space is a space behind a fence, which protects people from the hazardous traditional robots. UR robots are designed to work without a fence using built-in power and force limiting collaborative safety functions, and therefore without a hazardous safeguarded space defined by the perimeter of a fence.
- “5.4.2 Performance requirement”. All safety functions are constructed as PLd according to ISO 13849-1:2006. The robot is constructed with redundant encoder systems in each joint, and the safety-rated I/Os are constructed with a Category¹ 3 structure. The safety-rated I/Os must be connected according to this manual to Category 3 safety-rated equipment to form a PLd structure of the complete safety function.

¹According to ISO 13849-1, see Glossary for more details.

- “5.7 Operating modes”. UR robots do not have different operating modes and therefore they do not have a mode selector.
- “5.8 Pendant controls”. This section defines protective features for the teach pendant, when it is to be used within a hazardous safeguarded space. Since UR robots are designed for collaborative operation, there is no hazardous safeguarded space like with traditional robots. UR robots are safer to teach than traditional robots. Instead of having to release a three-positioning enabling device, the operator can simply stop the robot with his hand. If a UR robots is installed in a hazardous safeguarded application, a three-positioning enabling device can be connected as instructed in this manual. Additionally see clarification in ISO/TS 15066 clause 5.4.5.
- “5.10 Collaborative operation requirements”. The power and force limiting collaborative safety functions of UR robots are always active. The visual design of the UR robots indicates that the robots are capable of being used for collaborative operations. The power and force limiting functions are designed according to ISO 10218-1 clause 5.10.5. Additionally see clarification in ISO/TS 15066 clause 5.5.4.
- “5.12.3 Safety-rated soft axis and space limiting”. This safety function is one of more safety functions configurable through software. A hash code is generated from the sittings of all these safety functions and is represented as a safety check identifier in the GUI.

ISO/TS 15066:2016

Robots and robotic devices – Safety requirements for industrial robots – Collaborative operation

This is a Technical Specification (TS), **not** a standard. The purpose of a TS is to present a set of immature requirements to see if they are useful for a given industry. By definition, a TS is not mature enough to be harmonized under European Directives.

This TS is for both robot manufacturer and robot integrator. UR robots comply with the parts that are relevant for the raw robots themselves and the integrator can choose to use the TS when integrating the robots.

This TS presents voluntary requirements and guidance that are supplementary to the ISO 10218 standards in the field of collaborative robots. In addition to the main text the TS includes an annex A with a table that presents suggestions for force and pressure limits, which are based on pain and **not** injury. It is important to read and understand the notes under this table, as many of the limits are based on conservative estimates and literature study only. All numbers are subject to change in the future, as new results from scientific research are ready. Annex A is an informal and voluntary part of the TS and an integrator can therefore state compliance with the TS without using the limit values in Annex A.

ANSI/RIA R15.06-2012

Industrial Robots and Robot Systems – Safety Requirements

This American standard is the ISO standards ISO 10218-1 and ISO 10218-2 combined into one document. The language is changed from British English to American English, but the content is the same.

Note that part two (ISO 10218-2) of this standard is intended for the integrator of the robot system, and not Universal Robots.

CAN/CSA-Z434-14

Industrial Robots and Robot Systems – General Safety Requirements

This Canadian standard is the ISO standards ISO 10218-1 (see above) and -2 combined into one document. CSA added additional requirements for the user of the robot system. Some of these requirements might need to be addressed by the robot integrator.

Note that part two (ISO 10218-2) of this standard is intended for the integrator of the robot system, and not Universal Robots.

IEC 61000-6-2:2005

IEC 61000-6-4/A1:2010

EN 61000-6-2:2005 [2004/108/EC]

EN 61000-6-4/A1:2011 [2004/108/EC]

Electromagnetic compatibility (EMC)

Part 6-2: Generic standards - Immunity for industrial environments

Part 6-4: Generic standards - Emission standard for industrial environments

These standards define requirements for the electrical and electromagnetic disturbances. Conforming to these standards ensures that the UR robots perform well in industrial environments and that they do not disturb other equipment.

IEC 61326-3-1:2008

EN 61326-3-1:2008

Electrical equipment for measurement, control and laboratory use - EMC requirements

Part 3-1: Immunity requirements for safety-related systems and for equipment intended to perform safety-related functions (functional safety) - General industrial applications

This standard defines extended EMC immunity requirements for safety-related functions. Conforming to this standard ensures that the safety functions of UR robots provide safety even if other equipment exceeds the EMC emission limits defined in the IEC 61000 standards.

IEC 61131-2:2007 (E)

EN 61131-2:2007 [2004/108/EC]

Programmable controllers

Part 2: Equipment requirements and tests

Both normal and safety-rated 24V I/Os are constructed according to requirements of this standard to ensure reliable communication with other PLC systems.

ISO 14118:2000 (E)
EN 1037/A1:2008 [2006/42/EC]

Safety of machinery – Prevention of unexpected start-up

These two standards are very similar. They define safety principles for avoiding unexpected start-up, both as a result of unintended repowering during maintenance or repair, and as a result of unintended start-up commands from a control perspective.

IEC 60947-5-5/A1:2005
EN 60947-5-5/A11:2013 [2006/42/EC]

Low-voltage switchgear and controlgear

Part 5-5: Control circuit devices and switching elements - Electrical emergency stop device with mechanical latching function

The direct opening action and the safety lock mechanism of the emergency stop button comply with requirements in this standard.

IEC 60529:2013
EN 60529/A2:2013

Degrees of protection provided by enclosures (IP Code)

This standard defines enclosure ratings regarding protection against dust and water. UR robots are designed and classified with an IP code according to this standard, see robot sticker.

IEC 60320-1/A1:2007
IEC 60320-1:2015
EN 60320-1/A1:2007 [2006/95/EC]
EN 60320-1:2015

Appliance couplers for household and similar general purposes

Part 1: General requirements

The mains input cable complies with this standard.

ISO 9409-1:2004 [Type 50-4-M6]

Manipulating industrial robots – Mechanical interfaces

Part 1: Plates

The tool flange on UR robots conforms to type 50-4-M6 of this standard. Robot tools should also be constructed according to this standard to ensure proper fitting.

ISO 13732-1:2006

EN ISO 13732-1:2008 [2006/42/EC]

Ergonomics of the thermal environment – Methods for the assessment of human responses to contact with surfaces

Part 1: Hot surfaces

The UR robots are designed so that the surface temperature is kept under the ergonomic limits defined in this standard.

IEC 61140/A1:2004

EN 61140/A1:2006 [2006/95/EC]

Protection against electric shock – Common aspects for installation and equipment

UR robots are constructed in compliance with this standard to provide protection against electrical shock. A protective earth/ground connection is mandatory, as defined in the Hardware Installation Manual.

IEC 60068-2-1:2007

IEC 60068-2-2:2007

IEC 60068-2-27:2008

IEC 60068-2-64:2008

EN 60068-2-1:2007

EN 60068-2-2:2007

EN 60068-2-27:2009

EN 60068-2-64:2008

Environmental testing

Part 2-1: Tests - Test A: Cold

Part 2-2: Tests - Test B: Dry heat

Part 2-27: Tests - Test Ea and guidance: Shock

Part 2-64: Tests - Test Fh: Vibration, broadband random and guidance

UR robots are tested according to the test methods defined in these standards.

IEC 61784-3:2010

EN 61784-3:2010 [SIL 2]

Industrial communication networks – Profiles

Part 3: Functional safety fieldbuses – General rules and profile definitions

This standards defines requirements for safety-rated communication buses.

IEC 60204-1/A1:2008**EN 60204-1/A1:2009 [2006/42/EC]**

Safety of machinery – Electrical equipment of machines

Part 1: General requirements

The general principles of this standard are applied.

IEC 60664-1:2007**IEC 60664-5:2007****EN 60664-1:2007 [2006/95/EC]****EN 60664-5:2007**

Insulation coordination for equipment within low-voltage systems

Part 1: Principles, requirements and tests

Part 5: Comprehensive method for determining clearances and creepage distances equal to or less than 2 mm

The electrical circuitry of UR robots is designed in compliance with this standard.

EUROMAP 67:2015, V1.11

Electrical Interface between Injection Molding Machine and Handling Device / Robot

UR robots equipped with the E67 accessory module to interface injection molding machines comply with this standard.

D Technical Specifications

Robot type	UR10
Weight	28.9 kg / 63.7 lb
Maximum payload	10 kg / 22 lb
Reach	1300 mm / 51.2 in
Joint ranges	± 360° for all joints
Speed	Base and Shoulder joints: Max 120°/s. All other joints: Max 180°/s. Tool: Approx. 1 m/s / Approx. 39.4 in/s.
Pose Repeatability	± 0.1 mm / ± 0.0039 in (4 mils) per ISO 9283
Footprint	Ø190 mm / 7.5 in
Degrees of freedom	6 rotating joints
Control Box Size (W × H × D)	462 mm × 418 mm × 268 mm / 18.2 in × 16.5 in × 10.6 in
Control box I/O Ports	16 digital in, 16 digital out, 2 analog in, 2 analog out
Tool I/O Ports	2 digital in, 2 digital out, 2 analogue in
I/O Power Supply	24 V 2 A in Control Box
Communication	TCP/IP 1000 Mbit: IEEE 802.3u, 100BASE-T Ethernet socket, modbus TCP & EtherNet/IP Adapter, Profinet
Programming	PolyScope graphical user interface on 12" touchscreen
Noise	72 dB(A)
IP classification	IP54
Cleanroom classification	Robot Arm: ISO Class 5 Control Box: ISO Class 6
Maximum Average Power	585 W
Power consumption	Approx. 350 W using a typical program
Collaboration operation	15 advanced safety functions. In compliance with: EN ISO 13849-1:2008, PLd and EN ISO 10218-1:2011, clause 5.10.5
Materials	Aluminium, PP plastic
Temperature	The robot can work in an ambient temperature range of 0-50 °C
Power supply	100-240 VAC, 50-60 Hz
Cabling	Cable between robot and Control Box (6 m / 236 in) Cable between touchscreen and Control Box (4.5 m / 177 in)

E Safety Functions Tables

E.1 Table 1

Table 1: Safety Function (SF) Descriptions NOTE: all safety functions are individual safety functions

TUV NORD Certified SF	Internal?	Safety Function	Description	What is controlled?
SF0	Internal	Emergency Stop 1, 2, 3, 4 <i>There are two Emergency Stop safety functions</i>	Pressing Estop on the Teach Pendant ¹ or the External Estop (if using the Estop Safety Input configured for Estop) results in both a Cat 0 & a Cat 1 stop according to IEC 60204-1 (NFPA79) ³ . These are SF0 and SF1, respectively.	Robot Arm
SF1			<ul style="list-style-type: none"> • SF0: 524ms timer setting in each safety controller's microprocessor. At the end of the 524ms, Cat 0 stop³ (IEC 60204-1) is initiated by each microprocessor. • SF1: Command¹ all joints and power to stop. This is a Cat 1 stop³ per IEC 60204-1. • The stopping times⁴ of the SF0 and SF1 Estop safety functions differ. • SF0 has a functional safety rating of PLd Cat3 which stops power immediately with a worst-case scenario stopping time of 1250ms, even if all joint monitoring failed at the same time and the robot is at maximum speed after 524ms. • SF1 has a safety rating of PLd Cat2 (see page 6) with a maximum stop time of 300ms for UR3 and 400ms for UR5/UR10. See the User Manual for more information. The stop time can be reduced by the application's safety limit (SF3, 4, 6, 7, 8, 9) settings and the stop times provided in the User Manual. 	
SF2	Logic and outputs INTERNAL	Safeguard Stop (Protective Stop)	This safety function is initiated by an external protective device using safety inputs which initiates a Cat 2 stop ³ per IEC 60204-1. <i>For the safety rating of the completely integrated safety function, add the PFHd of the external protective device to the PFHd of SF2. If a PLd Cat3 stop is needed for protective devices, connect the protective device and configure the input as if it were an external Estop input (See SF0).</i>	Robot Arm
SF3	Internal	Joint Position Limit (soft axis limiting)	Exceeding the Joint Position limit results in a Cat 0 stop ³ (IEC 60204-1). Each joint can have its own limit. <i>Limits the set of allowed Joint Positions that the joints can move to. It is set directly in the safety setup part of the UI where you can enter values. It is a means of safety-rated soft axis limiting and space limiting, according to ISO 10218-1:2011, 5.12.3.</i>	Joint (each)
SF4	Internal	Joint Speed Limit	Exceeding a Joint Speed limit results in a Cat 0 stop ³ per IEC 60204-1. Each joint can have its own limit.	Joint (each)

¹ **Communications between the Teach Pendant, controller, & the robot arm (between joints) are SIL 2**, according to IEC 61784-3. Any failure will be detected within 16ms. See [NOTES](#)

² **Estop validation:** The Estop button is evaluated within the Teach Pendant, then communicated¹ to the safety controller by SIL2. To validate the Teach Pendant Estop functions, press the Estop button and verify an Estop results. See Estop Output for information about Estop I/O.

³ **Stop Categories** according to IEC 60204-1 (NFPA79)

- **Category 0 and 1** result in the removal of drive power, with Cat 0 being IMMEDIATE and Cat 1 being a controlled stop (decelerate, then power removal). Estop is either Cat 0 or Cat 1. As an exception, Estop can result in a Cat 2 stop.
- **Category 2** is a stop where drive power is NOT removed. Category 2 stop specifications are defined in IEC 60204-1, while SS1 and SS2 are defined IEC 61800-5-2.

⁴ **Emergency Stop response time:** Selecting Estop results in having both PLd Cat 2 and PLd Cat 3 Estops. It is an integration decision whether the PLd Cat2 or PLd Cat3 response time is used for calculating the stopping distance. Typically, the protective stop stopping time is intended for protective purposes.

⁵ **Stop Categories** according to IEC 60204-1 (NFPA79)

- **Category 0 and 1** The drive power is removed, with Cat 0 being IMMEDIATE and Cat 1 being a controlled stop (decelerate, then power removal). Estop must be either Cat 0 or Cat 1.
- **Category 2** The drive power is NOT removed. Category 2 stop specifications are defined in IEC 60204-1, while SS1 and SS2 are defined IEC 61800-5-2.

TUV NORD Certified SF	Internal?	Safety Function	Description	What is controlled?
			Limits the set of allowed Joint Speeds. It is in the Teach Pendant's safety setup where you can enter values. It can be used to limit fast joint movements, for instance to limit risks related to singularities.	
SF5	Internal	Joint Torque Limit	Exceeding the joint torque limit results in a Cat 0 stop ⁵ (per IEC 60204-1). This is not accessible to the user as it is a factory setting, part of the force limiting safety function.	Joint (each)
SF6	Internal	TCP Pose Limit	Monitors the TCP position and orientation. Any violation of a safety plane or TCP Pose Limit results in a Cat 0 stop ⁵ (IEC 60204-1). <i>This safety function consists of two parts: (1) The safety planes which limit the possible TCP positions by providing TCP inclusion/exclusion zones, and (2) The TCP orientation limit, which has an aLOWed direction and a tolerance. When a limit (plane or TCP pose) is violated, a Cat 0 stop is initiated.</i>	TCP
SF7	Internal	TCP Speed Limit	Exceeding the TCP speed limit results in a Cat 0 stop ⁵ (IEC 60204-1).	TCP
SF8	Internal	TCP Force Limit	Exceeding the TCP force limit results in a Cat 0 stop ⁵ (IEC 60204-1). <i>Limits the external clamping force exerted by the robot. See also Joint Torque Limit (SF5).</i>	TCP
SF9	Internal	Momentum Limit	Exceeding the Momentum Limit results in a Cat 0 stop ⁵ (IEC 60204-1). <i>The Momentum Limit is useful for limiting transient impacts and affects the entire robot arm.</i>	Robot Arm
SF10	Internal	Power Limit	Exceeding the Power Limit results in a Cat 0 stop ⁵ (IEC 60204-1). <i>This function monitors the mechanical work (sum of joint torques times joint angular speeds) performed by the robot. This affects the current to, and the speed of, the robot arm. This function dynamically limits the current/torque but maintain the speed.</i>	Robot Arm
SF11	Internal as a function with dual outputs	UR Robot Estop Output	When configured for Estop output and there is an Estop condition (see SF1), the dual outputs are LOW. If there is no Estop condition, dual outputs are HIGH. Pulses are not used but are tolerated. <i>For the integrated functional safety rating with an external Estop device, add the PFHd of the UR Estop function (SFO or SF1) to the PFHd of the external logic (if any) and its components (e.g. Estop pushbutton).</i> ⁶	External connection to logic &/or equipment
SF12	Internal as a function with dual outputs	UR Robot Moving: Digital Output	Whenever the robot is moving, the dual Digital Outputs are LOW. Outputs are HIGH when the robot is not moving. <i>The functional safety rating is for inside the robot. The integrated functional safety performance requires adding this PFHd to the PFHd of the external logic (if any) and its components.</i>	External connection to logic &/or equipment
SF13	Internal as a function with dual outputs	UR Robot Not stopping: Digital Output	Whenever the robot is STOPPING (i.e., in the process of stopping or in a stand-still condition) the dual Digital Outputs are HIGH. When outputs are LOW, robot is NOT in the process or stopping and NOT in a stand-still condition. <i>The functional safety rating is for inside the robot. The integrated functional safety performance requires adding this PFHd to the PFHd of the external logic (if any) and its components.</i>	External connection to logic &/or equipment
SF14	Internal as a function with dual outputs	UR Robot Reduced Mode: Digital Output	Whenever the robot is in Reduced Mode , the dual Digital Outputs are LOW. See Robot Reduced Mode below. <i>The functional safety rating is for inside the robot. The integrated functional safety performance requires adding this PFHd to the PFHd of the external logic (if any) and its components.</i>	External connection to logic &/or equipment
SF15	Internal as a function with dual outputs	UR Robot Not Reduced Mode:	Whenever the robot is NOT in Reduced Mode, the dual Digital Outputs are LOW. <i>The functional safety rating is for what is within the UR robot. The integrated functional safety performance requires adding this PFHd to the PFHd of the external logic (if any) and its components.</i>	External connection to logic &/or equipment

⁶ **Estop validation:** The Estop button is evaluated in the Teach Pendant, then communicated⁴ to the safety controller by SIL2 communications. See Communications and Safety Functions on page 10. To validate the Estop function, press the Teach Pendant Estop button and verify an Estop results. See footnote 13. The connection from the Teach Pendant to the safety controller is by safety communications according to SIL 2 (See page 10). See Estop Output for information about Estop I/O.

E.1 Table 1

TUV NORD Certified SF	Internal?	Safety Function	Description	What is controlled?
		Digital Output		
Robot Reduced Mode	Internal Logic and Outputs, with Dual Inputs (1 through 4)	Reduced Mode Input	Reduced Mode is initiated by a safety plane/boundary (starting at 2cm of the plane) or by use of an input to initiate (will achieve reduced settings within 500ms). When the external connections are LOW, Reduced Mode is initiated. Reduced Mode means that ALL Reduced Mode limits are ACTIVE. <i>Reduced Mode is not a safety function, rather it is a state affecting the settings of the following safety function limits: SF3 Joint Position, SF4 Joint Speed, SF6 TCP pose limit, SF7 TCP speed, SF8 TCP force, SF9 Momentum, and SF10 power.</i>	Robot Arm
Safeguard Reset	Internal Logic and Outputs, with Dual Inputs (1 through 4)	Safeguard Reset Input	When configured for Safeguard Reset and the external connections transition from LOW to HIGH, the safeguard stop RESETS. Safety input to initiate a reset of safeguard stop safety function SF2.	Robot
Enabling Device	External Enabling Device as input to UR Robot logic	Three-Position Enabling Device INPUT	When the external Enabling Device connections are LOW, a Safeguard Stop (SF2) is initiated. Recommendation: Use with a mode switch as a safety input. <i>If a mode switch is not used and connected to the safety inputs, then the robot mode will be determined by the Teach Pendant. If the Teach Pendant is in Run Mode—the enabling device will not be active.</i> <ul style="list-style-type: none"> Programming Mode—the enabling device will be active. Password protection is available to change modes. 	Robot
Mode Selection	External Mode Switch using dual Inputs (1 through 4) and internal logic	Mode Switch INPUT	When the external connections are LOW, Operation Mode (running) is in effect. When HIGH, it is Programming or Teach Mode. Must be used with an Enabling Device as a safety input. <i>When in Teach/Program Mode, the switch inputs are HIGH, and enabling device is required. When in Teach/Program Mode, the TCP Speed is limited to 250mm/s. The speed can be increased using the Teach Pendant "speed-slider," but upon activating the enabling device, the speed limit resets to 250mm/s.</i>	Robot

E.2 Table 2

Table 2: Compliance and ISO 13849-1 Functional Safety Information ^{7, 8}

TUV NORD Certified SF	Safety Function	Limits or USER configuration or Factory Setting	Stop Category per IEC 60204-1 ⁹	IEC 61800-5-2 Stop: power to switching devices retained for Category 2 Stop	PL	Cat	PFHd UR 3/5/10
SF0	Emergency Stop ^{8, 9, 10, 11, 12, 13, 14} There are two separate Emergency Stop safety functions: SF0 and SF1	No	Cat 1 Stop 524ms time-delay before Cat 0 Stop is initiated	NA	d	3	4.38E-8 See ¹⁰
SF1	Emergency Stop ^{11, 13, 14} There are two safety functions: SF0 & SF1	No	Cat 1 Stop when at SS1 standstill, Cat 0 Stop initiated	SS1 ¹⁵ when at SS1 standstill, Cat 0 Stop initiated	d	2	3.16E-07 See ¹⁰
SF2	Safeguard Stop (Protective Stop)	No	Cat 2	SS2 ¹⁶	d	2	3.15E-07

⁷ All safety functions are individual safety functions.

⁸ **MTTFd is limited to 100 years by ISO 13849-1.** The actual MTTFd values are greater than 100 years. **For all safety functions, the DCavg is 90%.**

⁹ **Stop Categories according to IEC 60204-1 (NFPA79).**

- **Category 0 and 1** result in the removal of drive power, with Cat 0 being IMMEDIATE and Cat 1 being a controlled stop before removal of power. Estop is either Cat 0 or Cat 1.
- **Category 2** is a stop where drive power is NOT removed. For Category 2 stops, specifications are defined in IEC 60204-1, while SS1 and SS2 are defined IEC 61800-5-2.

¹⁰ **Emergency stop safety functions:** MTTFd, DCavg and PFHd uses fault exclusion in accordance with ISO 13849-1 due to use of direct acting contacts. If fault exclusion were **not** used, then the PFHd values would be: **SF0:** 1.60E-07; **SF1:** 4.27E-07; **SF11:** 1.56E-07.

¹¹ **Emergency stop components and safety function** complies with IEC 60204-1, IEC 60947-5-1 (direct acting contacts), ISO 13850 and ISO 13849-1.

¹² **Communications between the Teach Pendant and the controller, as well as within the robot arm & between joints are SIL 2** for safety data, according to IEC 61784-3. Any failure will be detected within 16ms. See Communications and Safety Functions on page [10](#).

¹³ **Estop validation:** The Teach Pendant Estop button is evaluated in the Teach Pendant, then communicated¹ to the safety controller by SIL2 communications. To validate the Teach Pendant Estop function, press the Teach Pendant Estop button and verify an Estop results. See Estop Output for information about Estop I/O.

¹⁴ **Emergency Stop response time:** From a Teach Pendant standpoint, selecting Estop results in having both the PLd Cat 2 and PLd Cat 3 Estop. It is an integration decision whether the PLd Cat2 or PLd Cat3 response time is used to calculate the stopping distance.

¹⁵ **SS1 (Safe Stop 1)** according to IEC 615800-5-2

- a) Initiates and controls the motor deceleration rate within set limits to stop the motor and initiates the STO function when the motor speed is below a specified limit; or
- b) Initiates and monitors the motor deceleration rate within set limits to stop the motor and initiates the STO function when the motor speed is below a specified limit; or
- c) Initiates the motor deceleration and initiates the STO function after an application specific time delay.

NOTE: This safety function corresponds to a controlled stop in accordance with stop category 1 of IEC 60204-1.

¹⁶ **SS2 (Safe Stop 2)** according to IEC 615800-5-2

- a) Initiates and controls the motor deceleration rate within set limits to stop the motor and initiates the safe operating stop function when the motor speed is below a specified limit; OR

E.2 Table 2

TUV NORD Certified SF	Safety Function	Limits or USER configuration or Factory Setting	Stop Category per IEC 60204-1 ⁹	IEC 61800-5-2 Stop: power to switching devices retained for Category 2 Stop	PL	Cat	PFHd UR 3/5/10
Mode Selection	Mode switch INPUT	Input & I/O Configuration	Cat 2	SS2 ¹⁸	d	2	3.15E-07

NOTES:

All safety functions are individual safety functions. The UR safety controller has two microprocessors for monitoring incoming inputs, logic, and communications.

Stopping times of the SF0 and SF1 Emergency Stop safety functions:

SF0 has a functional safety rating of PLd Cat3. This means the worst-case stopping time is 1250ms, even if all joint safety monitoring failed at the same time, at full speed, and after 524ms.

SF1 has a functional safety rating of PLd Cat2 with a maximum stop time of approximately 300ms for UR3 and 400ms for UR5/UR10 (see the User Manual for information). The application stop time can be reduced depending on the application's safety limits (SF3, 4, 6, 7, 8, 9, 10) settings and the use of the stop time information provided in the manual. *From a Teach Pendant standpoint, selecting Estop results in having both a PLd Cat 2 and PLd Cat 3 Estop.*

SF2 has a functional safety rating of PLd Cat2 with a reliable (see functional safety information) and realistic maximum stop time of approximately 300ms for UR3 and 400ms for UR5/UR10. See the User Manual for specific information. The application stop time can be reduced depending on the application's safety limits (SF3, 4, 6, 7, 8, 9, 10) settings and the use of the stop time information provided in the manual.

It is an integration decision whether the Protective Stop (PLd Cat2) or the Emergency Stop (PLd Cat3) response time is to be used for the calculation of the stopping distance. Since the Emergency Stop is not considered a safeguard, it is typically recommended to use the Safeguard Stop (Protective Stop) stopping time.

Communications and Safety Functions:

Communications between the Teach Pendant and the controller, as well as within the robot arm & between joints are SIL 2 for safety data, according to IEC 61784-3. Any failure will be detected within 16ms. Some diagnostics require filtering of data to avoid false positives. In these cases, the detection of a fault can range from 8 to 25ms. Depending on the safety function and its diagnostics, fault detection is between 16ms and 33ms. It is recommended to use 33ms, due to the detection variability.

Copyright © 2009–2019 by Universal Robots A/S. All rights reserved.

Part II

PolyScope Manual

10 Safety Configuration

10.1 Introduction

The robot is equipped with an advanced safety system. Depending on the particular characteristics of the robot workspace, the settings for the safety system must be configured to guarantee the safety of all personnel and equipment around the robot. Applying settings defined by the risk assessment is the first thing the integrator must do. For details on the safety system, see the Hardware Installation Manual.



DANGER:

1. Use and configuration of safety-related functions and interfaces must be done according to the risk assessment that the integrator conducts for a specific robot application, see the Hardware Installation Manual.
2. Safety configuration settings for set-up and teaching must be applied according to the risk assessment conducted by the integrator and before the robot arm is powered on for the first time.
3. All safety configuration settings accessible on this screen and its subtabs are required to be set according to the risk assessment conducted by the integrator.
4. The integrator is required to ensure that all changes to the safety configuration settings are done in compliance with the integrator's own risk assessment.
5. The integrator must prevent unauthorized persons from changing the safety configuration, e.g. by use of password protection.

The `Safety Configuration` screen can be accessed from the `Welcome` screen (see 11.4) by pressing the `Program Robot` button, selecting the `Installation` tab and tapping `Safety`. The safety configuration is password protected, see 10.8.

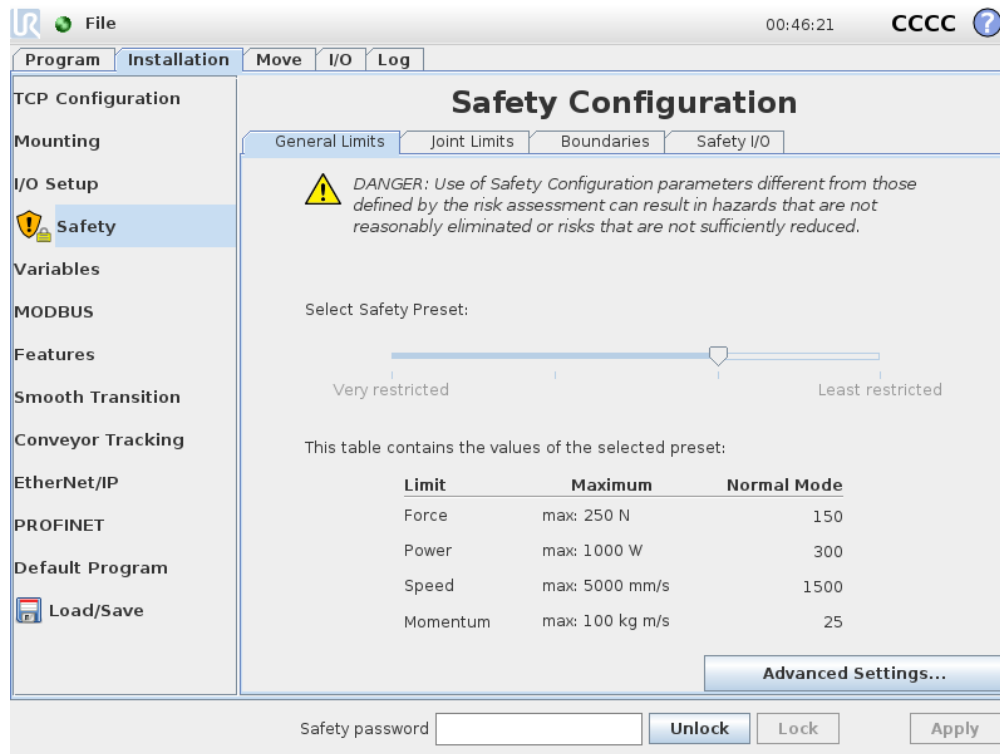

The safety settings consist of a number of limit values used to constrain the movements of the robot arm, and of safety function settings for the configurable inputs and outputs. They are defined in the following subtabs of the safety screen:

- The `General Limits` subtab defines the maximum *force*, *power*, *speed* and *momentum* of the robot arm. When the risk of hitting a human or colliding with a part of its environment is particularly high, these settings need to be set to low values. If the risk is low, higher general limits enable the robot to move faster and exert more force on its environment. For further details, see 10.10.
- The `Joint Limits` subtab consists of *joint speed* and *joint position* limits. The *joint speed* limits define the maximum angular velocity of individual joints and serve to further limit the speed of the robot arm. The *joint position* limits define the allowed position range of individual joints (in joint space). For further details, see 10.11.
- The `Boundaries` subtab defines safety planes (in Cartesian space) and a tool orientation boundary for the robot TCP. The safety planes can be configured either as hard limits for the position of the robot TCP, or triggers for activating the *Reduced* mode safety limits (see 10.6)). The tool orientation boundary puts a hard limit on the orientation of the robot TCP. For further details, see 10.12.
- The `Safety I/O` subtab defines safety functions for configurable inputs and outputs (see 13.2). For example, *Emergency Stop* can be configured as an input. For further details, see 10.13.

10.2 Changing the Safety Configuration

The safety configuration settings shall only be changed in compliance with the risk assessment conducted by the integrator.

The recommended procedure for changing the safety configuration is as follows:

1. Make sure that the changes are in compliance with the risk assessment conducted by the integrator.
2. Adjust safety settings to the appropriate level defined by the risk assessment conducted by the integrator.
3. Verify that the safety settings are applied.
4. Put the following text in the operators' manuals: "Before working near the robot, make sure that the safety configuration is as expected. This can be verified e.g. by inspecting the checksum in the top right corner of the PolyScope (see 10.5 in the PolyScope Manual)."

10.3 Safety Synchronization and Errors

The state of the applied safety configuration in comparison to what robot installation the GUI has loaded, is depicted by the shield icon next to the text `Safety` on the left side of the screen. These icons provide a quick indicator to the current state. They are defined below:

-  *Configuration Synchronized*: Shows the GUI installation is identical to the currently applied safety configuration. No changes have been made.
-  *Configuration Altered*: Shows the GUI installation is different from the currently applied safety configuration.

When editing the safety configuration, the shield icon will inform you whether or not the current settings have been applied.

If any of the text fields in the `Safety` tab contain any invalid input, the safety configuration is in an error state. This is indicated in several ways:

1. A red error icon is displayed next to the text `Safety` on the left side of the screen.
2. The subtab(s) with errors are marked with a red error icon at the top.
3. Text fields containing errors are marked with a red background.

When errors exist and attempting to navigate away from the `Installation` tab, a dialog appears with the following options:

1. Resolve the issue(s) so that all errors have been removed. This will be visible when the red error icon is no longer displayed next to the text `Safety` on the left side of the screen.
2. Revert back to the previously applied safety configuration. This will disregard all changes and allow you to continue to the desired destination.

If no errors exist and attempting to navigate away, a different dialog appears with the following options:

1. Apply changes and restart the system. This will apply the safety configuration modifications to the system and restart. Note: This does not imply that any changes have been saved; shut-down of the robot at this point will lose all changes to the robot installation including the Safety configuration.
2. Revert back to the previously applied safety configuration. This will disregard all changes and allow you to continue to the desired selected destination.

10.4 Tolerances

The *Robot Arm* uses built-in tolerances that prevent safety violations. A safety tolerance is the difference between a safety limit and a maximum operational value. For example, the general speed tolerance is -150mm/s . This means that if the user configures a 250mm/s speed limit, then the maximum operational speed will be $250 - 150 = 100\text{mm/s}$. Safety tolerances prevent safety violations while allowing for fluctuations in program behavior. For example, when handling a heavy payload, there may be situations where the *Robot Arm* needs to briefly operate above the normal maximum operational speed to follow a programmed trajectory. An example of such a situation is shown in figure 10.1.



WARNING:

A risk assessment is always required using the limit values without tolerances.



WARNING:

Tolerances are specific to the version of the software. Updating the software may change the tolerances. Consult the release notes for changes between versions.

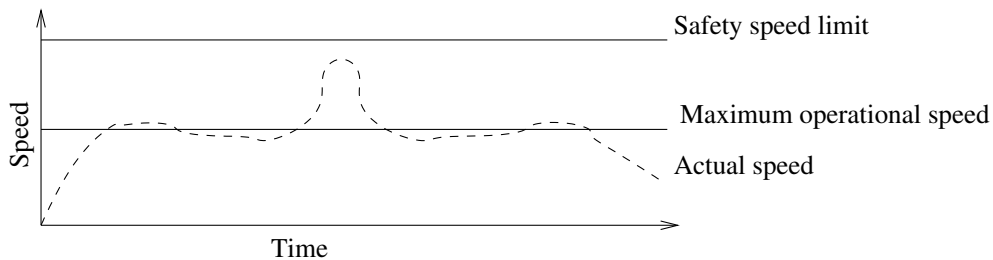

Figure 10.1: Safety tolerance example.

10.5 Safety Checksum

The text in the top right corner of the screen gives a shorthand representation of the safety configuration currently used by the robot. When the text changes, this indicates that the current safety configuration has changed as well. Clicking on the checksum displays the details about the currently active safety configuration.

10.6 Safety Modes

Under normal conditions (i.e. when no protective stop is in effect), the safety system operates in one of the following *safety modes*, each with an associated set of safety limits:

Normal mode: The safety mode that is active by default;

Reduced mode: Active when the robot TCP is positioned beyond a *Trigger Reduced mode* plane (see 10.12), or when triggered using a configurable input (see 10.13).

Recovery mode: When the robot arm is in violation of one of the other modes (i.e. *Normal* or *Reduced mode*) and a Stop Category 0 has occurred,¹ the robot arm will start up in **Recovery** mode. This mode allows the robot to move slowly back to the allowed area using **MoveTab** or **Freedrive**. It is not possible to run programs for the robot in this mode.



WARNING:

Note that limits for *joint position*, *TCP position* and *TCP orientation* are disabled in *Recovery* mode, so take caution when moving the robot arm back within the limits.

The subtabs of the *Safety Configuration* screen enable the user to define separate sets of safety limits for *Normal* and *Reduced* mode. For the tool and joints, *Reduced* mode limits regarding speed and momentum are required to be more restrictive than their *Normal* mode counterparts.

When a safety limit from the active limit set is violated, the robot arm performs a Stop Category 0. If an active safety limit, such as a joint position limit or a safety boundary, is violated already when the robot arm is powered on, it starts up in *Recovery* mode. This makes it possible to move the robot arm back within the safety limits. While in *Recovery* mode, the movement of the robot arm is limited by a fixed limit set that is not customizable by the user. For details about *Recovery* mode limits, see the Hardware Installation Manual.

10.7 Freedrive Mode

When in *Freedrive* mode (see 13.1.5) and the movement of the robot arm comes close to certain limits, the user will feel a repelling force. This force is generated for limits on the position, orientation and speed of the robot TCP and the position and speed of the joints.

The purpose of this repelling force is to inform the user that the current position or speed is close to a limit and to prevent the robot from violating that limit. However, if enough force is applied

¹According to IEC 60204-1, see Glossary for more details.

by the user to the robot arm, the limit can be violated. The magnitude of the force increases as the robot arm comes closer to the limit.

10.7.1 Backdrive

In *Freedrive* mode, the robot joints can be moved with relatively little force because the brakes are released. During initialization of the robot arm, minor vibrations may be observed when the robot brakes are released. In some situations, such as when the robot is close to collision, these tremors are undesirable and the *Backdrive* feature can be used to forcefully move specific joints to a desired position without releasing all brakes in the robot arm.

To enable *Backdrive*:

1. Press ON to enable power for the joints. The robot state is set to “Idle”. Do **not** release the brakes (i.e. do not press START).
2. Press and hold the *Freedrive* button. The robot state changes to “Backdrive”.
3. Brakes will only be released in the joints to which significant pressure is applied, as long as the *Freedrive* button is engaged/pressed. While using *Backdrive*, the robot feels heavy to move around.

10.8 Password Lock

All settings on this screen are locked until the correct safety password (see 15.3) is entered in the white text field at the bottom of the screen and the **Unlock** button is pressed. The screen can be locked again by clicking the **Lock** button. The **Safety** tab is automatically locked when navigating away from the safety configuration screen. When the settings are locked, a lock icon is visible next to the text **Safety** on the left side of the screen. An unlock icon is shown when the settings are unlocked.



NOTE:

Note that the robot arm is powered off when the safety Configuration screen is unlocked.

10.9 Apply

When unlocking the safety configuration, the robot arm will be powered off while changes are being made. The robot arm cannot be powered on until the changes have been applied or reverted, and a manual power on is performed from the initialization screen.

Any changes to the safety configuration must be applied or reverted, before navigating away from the Installation tab. These changes are *not* in effect until after the **Apply** button is pressed and confirmation is performed. Confirmation requires visual inspection of the changes given to the robot arm. For safety reasons, the information shown is given in SI Units. An example of the confirmation dialog is shown below.

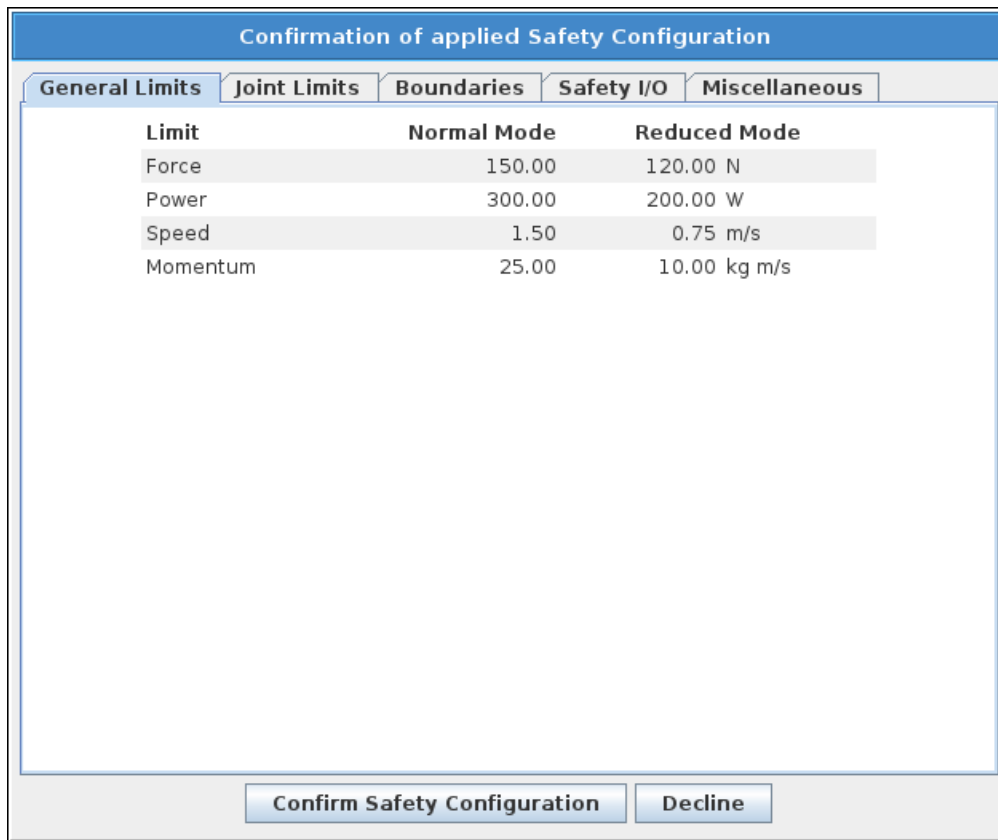

Furthermore, on confirmation the changes are automatically saved as part of the current robot installation. See 13.5 for further information on saving the robot installation.

10.10 General Limits

The general safety limits serve to limit the linear speed of the robot TCP as well as the force it may exert on the environment. They are composed of the following values:

Force: A limit for the maximum force that the robot TCP exerts on the environment.

Power: A limit for the maximum mechanical work produced by the robot on the environment, considering that the payload is part of the robot and not of the environment.

Speed: A limit for the maximum linear speed of the robot TCP.

Momentum: A limit for the maximum momentum of the robot arm.

There are two means available for configuring the general safety limits within the installation; *Basic Settings* and *Advanced Settings* which are described more fully below.

Defining the general safety limits only defines the limits for the tool, and not the overall limits of the robot arm. This means that although a speed limit is specified, it does *not* guarantee that other parts of the robot arm will obey this same limitation.

When in *Freedrive* mode (see 13.1.5), and the current speed of the robot TCP is close to the *Speed* limit, the user will feel a repelling force which increases in magnitude the closer the speed comes

to the limit. The force is generated when the current speed is within approximately 250 mm/s of the limit.

Basic Settings The initial general limits subpanel, shown as the default screen, features a slider with four predefined sets of values for force, power, speed, and momentum limits in both *Normal* and *Reduced* mode.

The specific sets of values are shown in the GUI. Predefined sets of values are suggestions only and shall not substitute a proper risk assessment.

Switching to Advanced Settings Should *none* of the predefined sets of values be satisfactory, the *Advanced Settings...* button can be pressed to enter the advanced general limits screen.

Advanced Settings

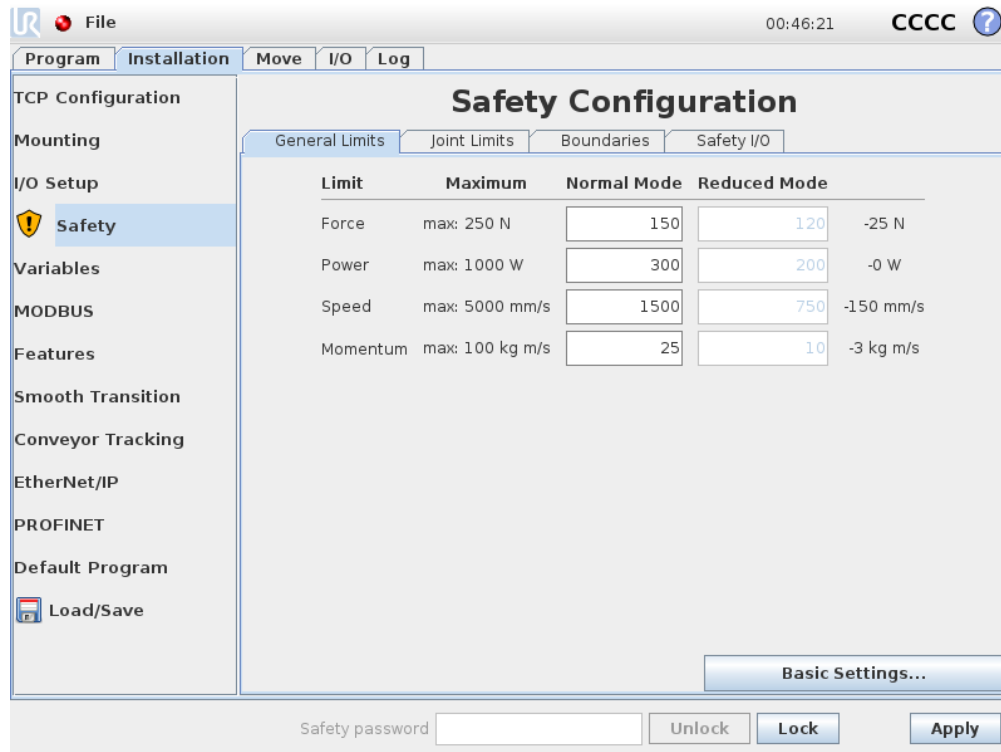

Here, each of the general limits, described in 10.10, can be modified independently of the others. This is done by tapping the corresponding text field and entering the new value. The highest accepted value for each of the limits is listed in the column titled *Maximum*. The force limit can be set to a value between 100 N and 250 N, and the power limit can be set to a value between 80 W and 1000 W.

Note: The fields for limits in *Reduced* mode are disabled when neither a safety plane nor a configurable input is set to trigger it (see 10.12 and 10.13 for more details). Furthermore, the *Speed* and *Momentum* limits in *Reduced* mode must not be higher than their *Normal* mode counterparts.

Copyright © 2009–2019 by Universal Robots A/S. All rights reserved.

10.11 Joint Limits

The tolerance and unit for each limit are listed at the end of the row that corresponds to it. When a program is running, the speed of the robot arm is automatically adjusted in order to not exceed any of the entered values minus the tolerance (see 10.4). Note that the minus sign displayed with the tolerance value is only there to indicate that the tolerance is subtracted from the actual entered value. The safety system performs a Stop Category 0, should the robot arm exceed the limit (without tolerance).



WARNING:

The speed limit is imposed only on the robot TCP, so other parts of the robot arm may move faster than the defined value.

Switching to Basic Settings Pressing the `Basic Settings...` button switches back to the basic general limits screen and all general limits are reset to their *Default* preset. Should this cause any customized values to be lost, a popup dialog is shown to confirm the action.

10.11 Joint Limits

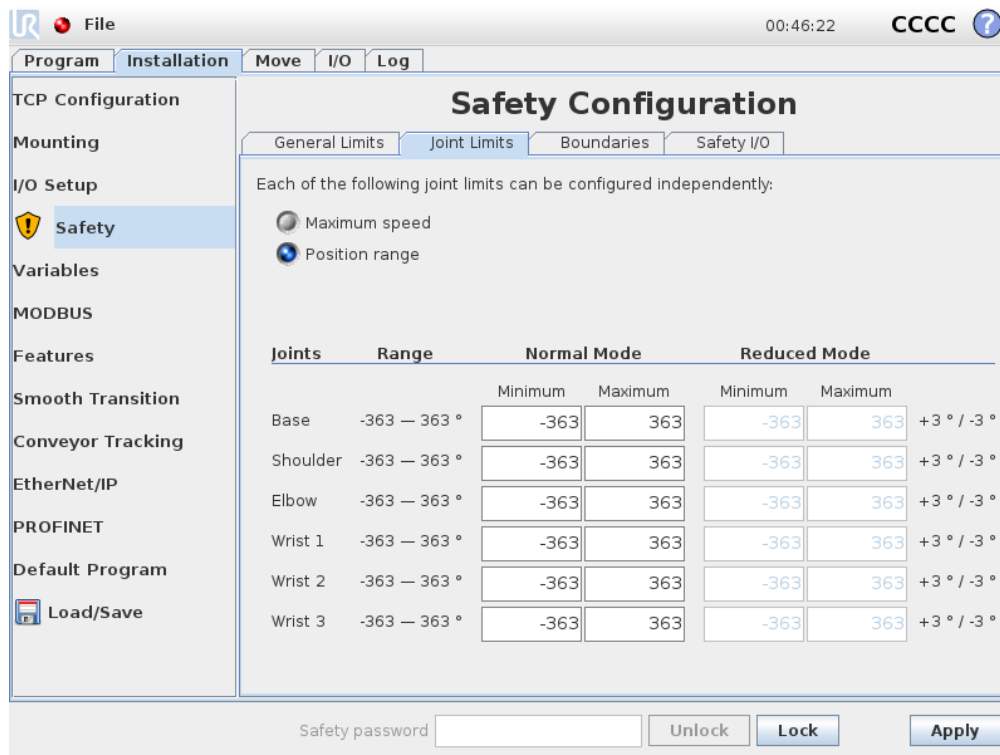

Each of the following joint limits can be configured independently:

- Maximum speed
- Position range

Joints	Range	Normal Mode		Reduced Mode		
		Minimum	Maximum	Minimum	Maximum	
Base	-363 – 363 °	-363	363	-363	363	+3 ° / -3 °
Shoulder	-363 – 363 °	-363	363	-363	363	+3 ° / -3 °
Elbow	-363 – 363 °	-363	363	-363	363	+3 ° / -3 °
Wrist 1	-363 – 363 °	-363	363	-363	363	+3 ° / -3 °
Wrist 2	-363 – 363 °	-363	363	-363	363	+3 ° / -3 °
Wrist 3	-363 – 363 °	-363	363	-363	363	+3 ° / -3 °

Safety password:

Joint limits restrict the movement of individual joints in joint space, i.e. they do not refer to Cartesian space but rather to the internal (rotational) position of the joints and their rotational speed. The radio buttons in the upper portion of the subpanel make it possible to independently set up Maximum Speed and Position Range for the joints.

When in *Freedrive* mode (see 13.1.5), and the current position or speed of a joint is close to the limit, the user will feel a repelling force which increases in magnitude as the joint approaches the limit. The force is generated when joint speed is within approximately 20°/s of the speed limit or joint position is within approximately 8° of the position limit.

The Wrist 3 position range is unlimited by default. When using cables attached to the robot, you must first disable the *Unrestricted Range for Wrist 3* checkbox to avoid cable tension and protective stops.

Maximum Speed This option defines the maximum angular velocity for each joint. This is done by tapping the corresponding text field and entering the new value. The highest accepted value is listed in the column titled *Maximum*. None of the values can be set below the tolerance value.

Note that the fields for limits in *Reduced* mode are disabled when neither a safety plane nor a configurable input is set to trigger it (see 10.12 and 10.13 for more details). Furthermore, the limits for *Reduced* mode must not be higher than their *Normal* mode counterparts.

The tolerance and unit for each limit are listed at the end of the row that corresponds to it. When a program is running, the speed of the robot arm is automatically adjusted in order to not exceed any of the entered values minus the tolerance (see 10.4). Note that the minus sign displayed with each tolerance value is only there to indicate that the tolerance is subtracted from the actual entered value. Nevertheless, should the angular velocity of some joint exceed the entered value (without tolerance), the safety system performs a Stop Category 0.

Position Range This screen defines the position range for each joint. This is done by tapping the corresponding text fields and entering new values for the lower and upper joint position boundary. The entered interval must fall within the values listed in the column titled *Range* and the lower boundary cannot exceed the upper boundary.

Note: The fields for limits in *Reduced* mode are disabled when neither a safety plane nor a configurable input is set to trigger it (see 10.12 and 10.13 for more details).

The tolerances and unit for each limit are listed at the end of the row that corresponds to it. The first tolerance value applies to the minimum value and the second applies to the maximum value. Program execution is aborted when the position of a joint is about to exceed the range resulting from adding the first tolerance to the entered minimum value and subtracting the second tolerance from the entered maximum value, if it continues moving along the predicted trajectory. Note that the minus sign displayed with the tolerance value is only there to indicate that the tolerance is subtracted from the actual entered value. Nevertheless, should the joint position exceed the entered range, the safety system performs a Stop Category 0.

10.12 Boundaries

In this tab you can configure boundary limits consisting of safety planes and a limit on the maximum allowed deviation of the robot tool orientation. It is also possible to define planes that trigger a transition into *Reduced* mode.

10.12 Boundaries

Safety planes can be used to restrict the allowed workspace of the robot by enforcing that the robot TCP stay on the correct side of the defined planes and not pass through them. Up to eight safety planes can be configured. The constraint on the orientation of tool can be utilized to ensure that the robot tool orientation does not deviate more than a certain specified amount from a desired orientation.



WARNING:

Defining safety planes only limits the TCP and not the overall limit for the robot arm. This means that although a safety plane is specified, it does *not* guarantee that other parts of the robot arm will obey this restriction.

The configuration of each boundary limit is based on one of the features defined in the current robot installation (see 13.12).



NOTE:

It is highly recommended, that you create all features needed for the configuration of all the desired boundary limits and assign them appropriate names before editing the safety configuration. Note that since the robot arm is powered off once the *Safety* tab has been unlocked, the `Tool` feature (containing the current position and orientation of the robot TCP) as well as *Freedrive* mode (see 13.1.5) will not be available.

When in *Freedrive* mode (see 13.1.5), and the current position of the robot TCP is close to a safety plane, or the deviation of the orientation of the robot tool from the desired orientation is close to the specified maximum deviation, the user will feel a repelling force which increases in magnitude as the TCP approaches the limit. The force is generated when the TCP is within approximately 5 cm of a safety plane, or the deviation of the orientation of the tool is approximately 3° from the specified maximum deviation.







When a plane is defined as a *Trigger Reduced mode* plane and the TCP goes beyond this boundary, the safety system transitions into *Reduced* mode which applies the *Reduced* mode safety settings. Trigger planes follow the same rules as regular safety planes except they allow the robot arm to pass through them.

10.12.1 Selecting a boundary to configure

The `Safety Boundaries` panel on the left side of the tab is used to select a boundary limit to configure.

To set up a safety plane, click on one of the top eight entries listed in the panel. If the selected safety plane has already been configured, the corresponding 3D representation of the plane is highlighted in the `3D View` (see 10.12.2) to the right of this panel. The safety plane can be set up in the `Safety Plane Properties` section (see 10.12.3) at the bottom of the tab.

Click the `Tool Boundary` entry to configure the orientation boundary limit for the robot tool. The configuration of the limit can be specified in the `Tool Boundary Properties` section (see 10.12.4) at the bottom of the tab.

Click the  /  button to toggle the 3D visualization of the boundary limit on/off. If a boundary limit is active, the *safety mode* (see 10.12.3 and 10.12.4) is indicated by one of the following icons  /  /  / .

10.12.2 3D visualization

The `3D View` displays the configured safety planes and the orientation boundary limit for the robot tool together with the current position of the robot arm. All configured boundary entries where the visibility toggle is selected (i.e. showing  icon) in the `Safety Boundaries` section are displayed together with the current selected boundary limit.

The (active) safety planes are shown in yellow and black with a small arrow representing the plane normal, which indicates the side of the plane on which the robot TCP is allowed to be positioned. Trigger planes are displayed in blue and green. A small arrow illustrates the side of the plane that does *not* trigger the transition into *Reduced* mode. If a safety plane has been selected in the panel on the left side of the tab, the corresponding 3D representation is highlighted.

The tool orientation boundary limit is visualized with a spherical cone together with a vector indicating the current orientation of the robot tool. The inside of the cone represents the allowed area for the tool orientation (vector).

When a plane or the tool orientation boundary limit is configured but not active, the visualization is gray.

Push the magnifying glass icons to zoom in/out or drag a finger across to change the view.

10.12.3 Safety plane configuration

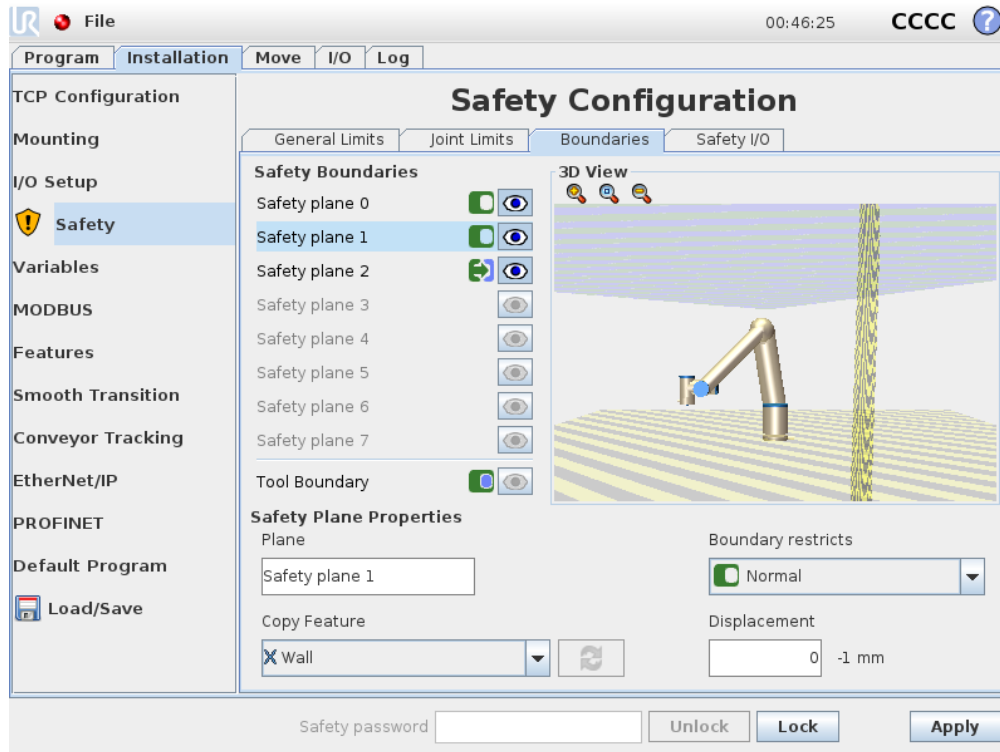

The `Safety Plane Properties` section at the bottom of the tab defines the configuration of the selected safety plane in the `Safety Boundaries` panel in the upper left portion of the tab.







Name The Name text field allows the user to assign a name to the selected safety plane. Change the name by tapping the text field and entering a new name.

Copy Feature The position and normal of the safety plane is specified using a feature (see 13.12) from the current robot installation. Use the drop-down box in the lower left portion of the Safety Plane Properties section to select a feature. Only the point and plane type features are available. Choosing the <Undefined> item clears the configuration of the plane.

The z-axis of the selected feature will point to the disallowed area and the plane normal will point in the opposite direction, except when the Base feature is selected, in which case the plane normal will point in the same direction. If the plane is configured as a *Trigger Reduced mode* plane (see 10.12.3), the plane normal indicates the side of the plane that does *not* trigger transition into *Reduced* mode.

It should be noted that when the safety plane has been configured by selecting a feature, the position information is only *copied* to the safety plane; the plane is *not* linked to that feature. This means that if there are changes to the position or orientation of a feature which has been used to configure a safety plane, the safety plane is not automatically updated. If the feature has changed, this is indicated by a  icon positioned over the feature selector. Click the  button next to the selector to update the safety plane with the current position and orientation of the feature. The  icon is also displayed if the selected feature has been deleted from the installation.

Safety mode The drop down menu on the right hand side of the Safety Plane Properties panel is used to choose the *safety mode* for the safety plane, with the following modes available:

Disabled	The safety plane is <i>never active</i> .
 Normal	When the safety system is in <i>Normal</i> mode, a <i>Normal</i> mode plane is <i>active</i> and it acts as a <i>strict limit</i> on the position of the robot TCP.
 Reduced	When the safety system is in <i>Reduced</i> mode, a <i>Reduced</i> mode plane is <i>active</i> and it acts as a <i>strict limit</i> on the position of the robot TCP.
 Normal & Reduced	When the safety system is either in <i>Normal</i> or <i>Reduced</i> mode, a <i>Normal & Reduced</i> mode plane is <i>active</i> and it acts as a <i>strict limit</i> on the position of the robot TCP.
 Trigger Reduced mode	When the safety system is either in <i>Normal</i> or <i>Reduced</i> mode, a <i>Trigger Reduced mode</i> plane is <i>active</i> and it causes the safety system to switch to <i>Reduced</i> mode for as long as the robot TCP is positioned beyond it.

The selected *safety mode* is indicated by an icon in the corresponding entry in the `Safety Boundaries` panel. If the *safety mode* is set to `Disabled`, no icon is shown.

Displacement When a feature has been selected in the drop down box in the lower left portion of the `Safety Plane Properties` panel, the safety plane can be translated by tapping the `Displacement` text field in the lower right portion of this panel and entering a value. Entering in a positive value increases the allowed workspace of the robot by moving the plane in the opposite direction of the plane normal, while entering a negative value decreases the allowed area by moving the plane in the direction of the plane normal.

The tolerance and unit for the displacement of the boundary plane are shown to the right of the text field.

Effect of *strict limit* planes Program execution is aborted when the TCP position is about to cross an active, strict limit safety plane minus the tolerance (see 10.4), if it continues moving along the predicted trajectory. Note that the minus sign displayed with the tolerance value is only there to indicate that the tolerance is subtracted from the actual entered value. The safety system will perform a Stop Category 0, should the TCP position exceed the specified limit safety plane (without tolerance).

Effect of *Trigger Reduced mode* planes When no protective stop is in effect and the safety system is not in the special *Recovery* mode (see 10.6), it operates either in *Normal* or *Reduced* mode and the movements of the robot arm are limited by the respective limit set.

By default, the safety system is in *Normal* mode. It transitions into *Reduced* mode whenever one of the following situations occurs:

10.12 Boundaries

- a) The robot TCP is positioned beyond some *Trigger Reduced mode* plane, i.e. it is located on the side of the plane that is *opposite* to the direction of the small arrow in the visualization of the plane.
- b) The *Reduced Mode* safety input function is configured and the input signals are low (see 10.13 for more details).

When none of the above is the case any longer, the safety system transitions back to *Normal mode*.

When the transition from *Normal* to *Reduced mode* is caused by passing through a *Trigger Reduced mode* plane, a transition from the *Normal mode* limit set to the *Reduced mode* limit set occurs. As soon as the robot TCP is positioned 20 mm or closer to the *Trigger Reduced mode* plane (but still on the *Normal mode* side), the more permissive of the *Normal* and *Reduced mode* limits is applied for each limit value. Once the robot TCP passes through the *Trigger Reduced mode* plane, the *Normal mode* limit set is no longer active and the *Reduced mode* limit set is enforced.

When a transition from *Reduced* to *Normal mode* is caused by passing through a *Trigger Reduced mode* plane, a transition from the *Reduced mode* limit set to the *Normal mode* limit set occurs. As soon as the robot TCP passes through the *Trigger Reduced mode* plane, the more permissive of the *Normal* and *Reduced mode* limits is applied for each limit value. Once the robot TCP is positioned 20 mm or further from the *Trigger Reduced mode* plane (on the *Normal mode* side), the *Reduced mode* limit set is no longer active and the *Normal mode* limit set is enforced.

If the predicted trajectory takes the robot TCP through a *Trigger Reduced mode* plane, the robot arm will start decelerating even before passing through the plane if it is about to exceed joint speed, tool speed or momentum limit in the new limit set. Note that since these limits are required to be more restrictive in the *Reduced mode* limit set, such premature deceleration can occur only when transitioning from *Normal* to *Reduced mode*.

10.12.4 Tool Boundary configuration

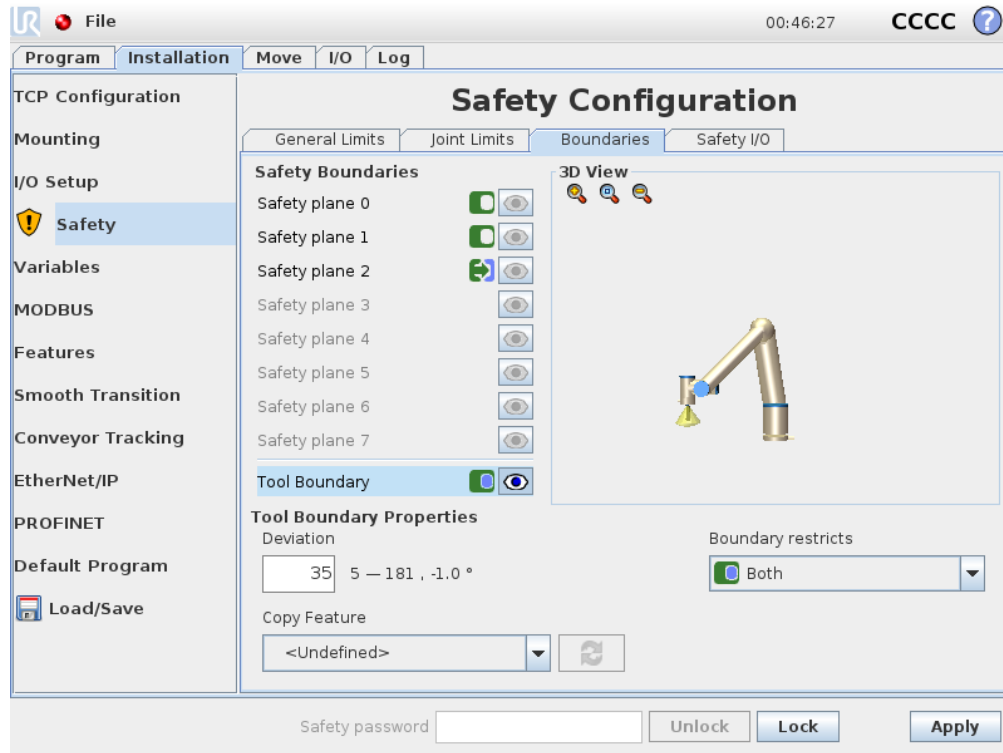

The **Tool Boundary Properties** panel at the bottom of the tab defines a limit on the orientation of robot tool composed of a desired tool orientation and a value for the maximum allowed deviation from this orientation.

Deviation The **Deviation** text field shows the value for the maximum allowed deviation of the orientation of the robot tool from the desired orientation. Modify this value by tapping the text field and entering the new value.



The accepted value range together with the tolerance and unit of the deviation are listed next to the text field.

Copy Feature The desired orientation of the robot tool is specified using a feature (see 13.12) from the current robot installation. The z-axis of the selected feature will be used as the desired tool orientation vector for this limit.

Use the drop down box in the lower left portion of the **Tool Boundary Properties** panel to select a feature. Only the point and plane type features are available. Choosing the **<Undefined>** item clears the configuration of the plane.

It should be noted that when the limit has been configured by selecting a feature, the orientation information is only *copied* to the limit; the limit is *not* linked to that feature. This means that if there are changes to the position and orientation of a feature, which has been used to configure the limit, the limit is not automatically updated. If the feature has changed, this is indicated by a  icon

10.12 Boundaries

positioned over the feature selector. Click the  button next to the selector to update the limit with the current orientation of the feature. The  icon is also displayed if the selected feature has been deleted from the installation.

Safety mode The drop down menu on the right hand side of the `Tool Boundary Properties` panel is used to choose the *safety mode* for the tool orientation boundary. The available options are:

<input type="checkbox"/> Disabled	The tool boundary limit is never active.
<input checked="" type="checkbox"/> Normal	When the safety system is in <i>Normal</i> mode, the tool boundary limit is active.
<input type="checkbox"/> Reduced	When the safety system is in <i>Reduced</i> mode, the tool boundary limit is active.
<input checked="" type="checkbox"/> Normal & Reduced	When the safety system is either in <i>Normal</i> or <i>Reduced</i> mode, the tool boundary limit is active.

The selected *safety mode* is indicated by an icon in the corresponding entry in the `Safety Boundaries` panel. If the *safety mode* is set to `Disabled`, no icon is shown.

Effect Program execution is aborted when the deviation of the tool orientation is about to exceed the entered maximum deviation minus the tolerance (see 10.4), if it continues moving along the predicted trajectory. Note that the minus sign displayed with the tolerance value is only there to indicate that the tolerance is subtracted from the actual entered value. The safety system will perform a Stop Category 0, should the deviation of the tool orientation exceed the limit (without tolerance).

10.13 Safety I/O

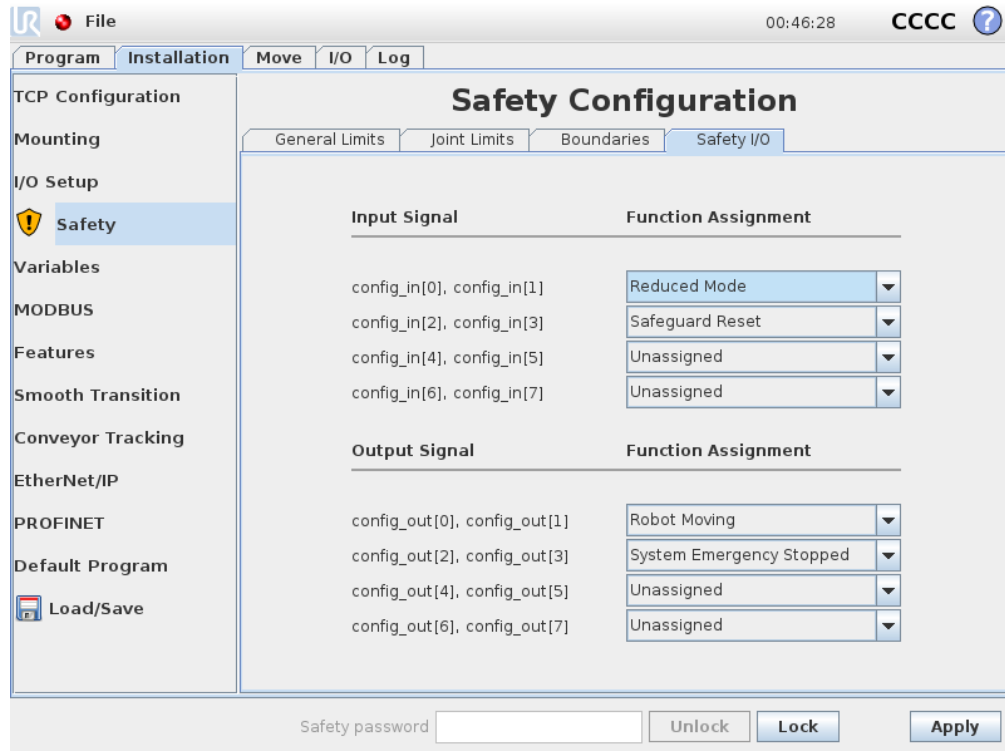

This screen defines the *Safety functions* for configurable inputs and outputs (I/Os). The I/Os are divided between the inputs and outputs, and are paired up so that each function is providing a Category² 3 and PLd I/O.

Each *Safety function* can only control one pair of I/Os. Trying to select the same safety function a second time removes it from the first pair of I/Os previously defined. There are 5 *Safety functions* for input signals, and 5 for output signals.

Note: Applying a safety function to a set of pins will override any I/O actions specified for pins in the I/O Setup (see 13.8).

10.13.1 Input Signals

For input signals, the following *Safety functions* can be selected: System Emergency Stop, Reduced Mode, Safeguard Reset, Three-Position Enabling Device and Operational Mode.

System Emergency Stop When configured, it allows for having an additional Emergency Stop button besides the Emergency Stop Button on the Teach Pendant. This functionality requires the use of an ISO 13850-compliant device.

²According to ISO 13849-1, see Glossary for more details.

Reduced Mode All safety limits have two modes in which they can be applied: *Normal* mode, which specifies the default safety configuration, and *Reduced* mode (see 10.6 for more details). When this input safety function is selected, a low signal given to the inputs causes the safety system to transition to *Reduced* mode. If necessary, the robot arm then decelerates to satisfy the *Reduced* mode limit set. Should the robot arm still violate any of the *Reduced* mode limits, it performs a Stop Category 0. The transition back to *Normal* mode happens in the same manner. Note that safety planes can also cause a transition to *Reduced* mode (see 10.12.3 for more details).



Safeguard Reset If Safeguard Stop is wired in the safety I/Os, then this input is used to ensure the Safeguard Stopped state continues until a reset is triggered. The robot arm will not move when in Safeguard Stopped state.



WARNING:

By default, the Safeguard Reset function is configured for input pins 0 and 1. Disabling it altogether implies that the robot arm ceases to be Safeguard Stopped as soon as the Safeguard Stop input becomes high. In other words, without a Safeguard Reset, the Safeguard Stop inputs SI0 and SI1 (see the Hardware Installation Manual) fully determine whether the Safeguard Stopped state is active or not.

Three-Position Enabling Device and Operational Mode These allow for using a 3-position enabling device as an additional protective measure during setup and programming of the robot. With the Three-Position Enabling Device input configured, the robot is either in “running mode” or “programming mode”. An icon will appear in the upper right corner displaying the current operational mode:

-  *Running mode*: Robot can perform only pre-defined tasks. The Move tab and Freedrive mode are unavailable.
-  *Programming mode*: The restrictions present in *Running mode* are lifted. However, whenever the Three-Position Enabling Device input is low, the robot is Safeguard Stopped. Also, the speed slider is set at an initial value that corresponds to 250 mm/s and can be incrementally increased to reach higher speed. The speed slider is reset to the low value whenever the Three-Position Enabling Device input goes from low to high.

There are two methods for configuring operational mode selection:

1. To select the operational mode using an external mode selection device, configure the Operational Mode input. The option to configure it will appear in the drop-down menus once the Three-Position Enabling Device input is configured. The robot will be in *Running mode* when the Operational Mode input is low and in *Programming mode* when it is high.
2. To select the operational mode from Polyscope, only the Three-Position Enabling Device input must be configured and applied to the Safety Configuration. In this case, the default

mode is *Running*. In order to switch to *Programming mode*, choose the “Program Robot” button on the Welcome screen. To switch back to *Running mode*, simply exit the “Program Robot” screen.



NOTE:

- After the Safety I/O configuration with *Three-Position Enabling Device* enabled is confirmed, the Welcome screen is automatically shown. The Welcome screen is also automatically displayed when the operational mode changes from *Programming* to *Running*.
- The physical mode selector, if used, must completely adhere to ISO 10218-1: article 5.7.1 for selection.
- The 3-position switch, along with its behavior, performance characteristics and operation, must thoroughly comply with ISO 10218-1: article 5.8.3 for an enabling device.

10.13.2 Output Signals

For the output signals the following *Safety functions* can be applied. All signals return to low when the state which triggered the high signal has ended:

System Emergency Stop Low signal is only given when the safety system has been triggered into an *Emergency Stopped* state by the Robot Emergency Stop input or Emergency Stop Button. To avoid deadlocks, if the *Emergency Stopped* state is triggered by the System Emergency Stop input, low signal will not be given.



NOTE:

External machinery obtaining the *Emergency Stop* state from the robot through *System Emergency Stop* output must be complying with ISO 13850. This is particularly necessary in setups where the Robot Emergency Stop input is connected to an external Emergency Stop device. In such cases, the *System Emergency Stop* output will become high when the external Emergency Stop device is released. This implies that the emergency stop state at the external machinery will be reset with no manual action needed from the robot’s operator. Hence, to comply with safety standards, the external machinery must require manual action in order to resume.

Robot Moving A low signal is given whenever the robot arm is in a mobile state. When the robot arm is in a fixed position, a high signal is given.

10.13 Safety I/O

Robot Not Stopping The signal is High when the robot is stopped or in the process of stopping due to an emergency stop or safeguard stop. Otherwise the signal is logic low.

Reduced Mode Sends a low signal when the robot arm is placed in *Reduced* mode or if the safety input is configured with a *Reduced Mode* input and the signal is currently low. Otherwise the signal is high.

Not Reduced Mode This is the inverse of the *Reduced Mode* defined above.

Copyright © 2009–2019 by Universal Robots A/S. All rights reserved.

11 Begin programming

11.1 Introduction

The Universal Robot arm is composed of tubes and joints. The joints with their usual names are shown in Figure 11.1. The **Base** is where the robot is mounted, and at the other end (**Wrist 3**) the tool of the robot is attached. By coordinating the motion of each of the joints, the robot can move its tool around freely, with the exception of the area directly above and directly below the base.

PolyScope is the graphical user interface (GUI) which lets you operate the robot arm and control box, execute robot programs and easily create new ones.

The following section gets you started with the robot. Afterwards, the screens and functionality of PolyScope are explained in more detail.



DANGER:

1. The Hardware Installation Manual contains important safety information, which must be read and understood by the integrator of UR robots before the robot is powered on for the first time.
2. The integrator must set the safety configuration parameters defined by the risk assessment before powering on the robot arm for the first time, see chapter 10.

11.2 Getting Started

Before using PolyScope, the robot arm and control box must be installed and the control box switched on.

11.2.1 Installing the Robot Arm and Control Box

To install the robot arm and control box, do the following:

1. Unpack the robot arm and the control box.
2. Mount the robot on a sturdy surface strong enough to withstand at least 10 times the full torque of the base joint and at least 5 times the weight of the robot arm. The surface shall be vibration-free.
3. Place the control box on its foot.
4. Plug on the robot cable between the robot and the control box.
5. Plug in the mains plug of the control box.

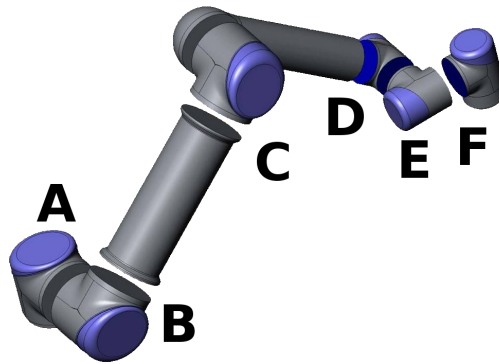

Figure 11.1: Joints of the robot. A: Base, B: Shoulder, C: Elbow and D, E, F: Wrist 1, 2, 3



WARNING:

Tipping hazard. If the robot is not securely placed on a sturdy surface, the robot can fall over and cause an injury.

Detailed installation instructions can be found in the Hardware Installation Manual. Note that a risk assessment is required before using the robot arm to do any work.

11.2.2 Turning the Control Box On and Off

The control box is turned on by pressing the power button at the front side of the panel with the touch screen. This panel is usually referred to as the *teach pendant*. When the control box is turned on, text from the underlying operating system will appear on the touch screen. After about one minute, a few buttons appear on the screen and a popup guides the user to the initialization screen (see 11.5).

To shut down the control box, press the green power button on the screen, or use the *Shut Down* button on the welcome screen (see 11.4).



WARNING:

Shutting down by pulling the power cord from the wall socket may cause corruption of the robot's file system, which may result in robot malfunction.

11.2.3 Turning the Robot Arm On and Off

The robot arm can be turned on if the control box is turned on, and if no emergency stop button is activated. Turning the robot arm on is done in the initialization screen (see 11.5) by touching the *ON* button on that screen, and then pressing *Start*. When a robot is started, it makes a sound and moves a little while releasing the brakes.

11.2 Getting Started

The power to the robot arm can be turned off by touching the `OFF` button on the initialization screen. The robot arm is also powered off automatically when the control box shuts down.

11.2.4 Quick Start

To quickly start up the robot after it has been installed, perform the following steps:

1. Press the emergency stop button on the front side of the teach pendant.
2. Press the power button on the teach pendant.
3. Wait a minute while the system is starting up, displaying text on the touch screen.
4. When the system is ready, a popup will be shown on the touch screen, stating that the robot needs to be initialized.
5. Touch the button on the popup dialog. You will be taken to the initialization screen.
6. Wait for the `Confirmation of applied Safety Configuration` dialog and press the `Confirm Safety Configuration` button. This applies an initial set of safety parameters that need to be adjusted based on a risk assessment.
7. Unlock the emergency stop button. The robot state changes from `Emergency Stopped` to `Power off`.
8. Step outside the reach (workspace) of the robot.
9. Touch the `On` button on the touch screen. Wait a few seconds until robot state changes to `Idle`.
10. Verify that the payload mass and selected mounting are correct. You will be notified if the mounting detected based on sensor data does not match the selected mounting.
11. Touch the `Start` button on the touch screen. The robot now makes a sound and moves a little while releasing the brakes.
12. Touch the `OK` button, bringing you to the `Welcome` screen.

11.2.5 The First Program

A program is a list of commands telling the robot what to do. PolyScope allows people with only little programming experience to program the robot. For most tasks, programming is done entirely using the touch panel without typing in any cryptic commands.

Tool motion is the part of a robot program that teaches the Robot Arm how to move. In PolyScope, tool motions are set using a series of **waypoints**. The combined waypoints form a path that the Robot Arm follows. A waypoint is set by using the `Move Tab`, manually moving (teaching) the robot to a certain position, or it can be calculated by software. Use the `Move tab` (see 13.1) to move the Robot Arm to a desired position, or teach the position by pulling the Robot Arm into place while holding the `Freedrive` button behind the `Teach Pendant`.

Besides moving through waypoints, the program can send I/O signals to other machines at certain points in the robot's path, and perform commands like **if...then** and **loop**, based on variables and I/O signals.

The following is a simple program that allows a Robot arm that has been started up, to move between two waypoints.

1. Touch the `Program Robot` button and select `Empty Program`.
2. Touch the `Next` button (bottom right) so that the `<empty>` line is selected in the tree structure on the left side of the screen.
3. Go to the `Structure` tab.
4. Touch the `Move` button.
5. Go to the `Command` tab.
6. Press the `Next` button, to go to the `Waypoint` settings.
7. Press the `Set this waypoint` button next to the “?” picture.
8. On the `Move` screen, move the robot by pressing the various blue arrows, or move the robot by holding the `Freedrive` button, placed on the backside of the teach pendant, while pulling the robot arm.
9. Press `OK`.
10. Press `Add waypoint before`.
11. Press the `Set this waypoint` button next to the “?” picture.
12. On the `Move` screen, move the robot by pressing the various blue arrows, or move the robot by holding the `Freedrive` button while pulling the robot arm.
13. Press `OK`.
14. Your program is ready. The robot will move between the two points when you press the “Play” symbol. Stand clear, hold on to the emergency stop button and press “Play”.
15. Congratulations! You have now produced your first robot program that moves the robot between the two given waypoints.

**WARNING:**

1. Do not drive the robot into itself or anything else as this may cause damage to the robot.
2. Keep your head and torso outside the reach (workspace) of the robot. Do not place fingers where they can be caught.
3. This is only a quick start guide to show how easy it is to use a UR robot. It assumes a harmless environment and a very careful user. Do not increase the speed or acceleration above the default values. Always conduct a risk assessment before placing the robot into operation.

11.3 PolyScope Programming Interface

PolyScope runs on the touch sensitive screen attached to the control box.

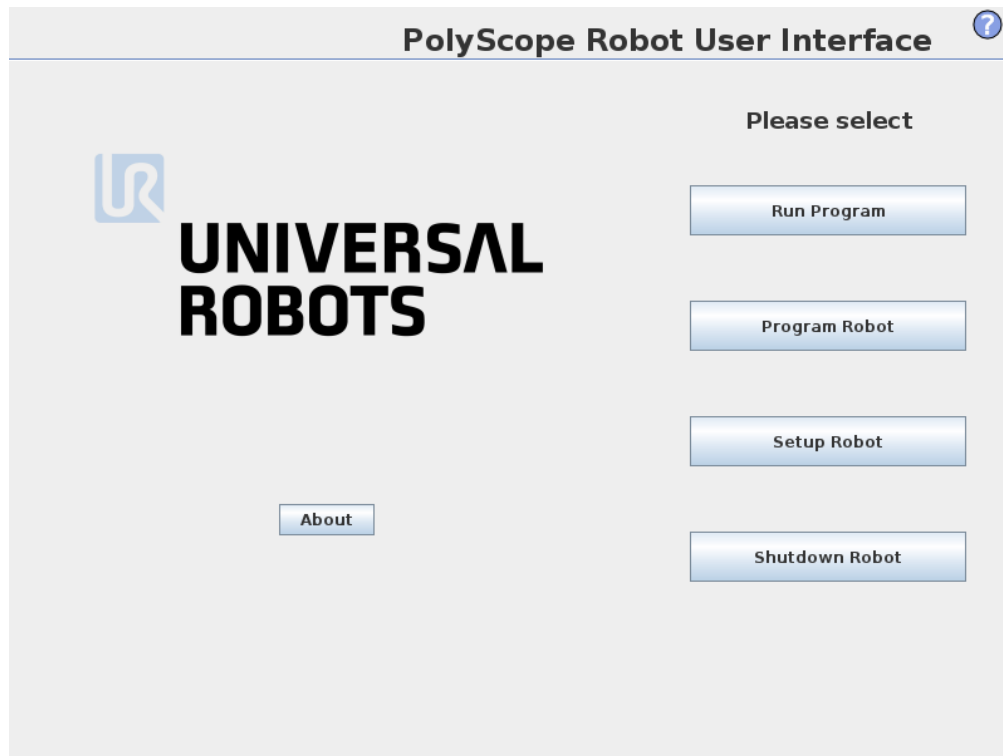

The picture above shows the Welcome Screen. The bluish areas of the screen are buttons that can be pressed by pressing a finger or the backside of a pen against the screen. PolyScope has a hierarchical structure of screens. In the programming environment, the screens are arranged in *tabs*, for easy access on the screens.

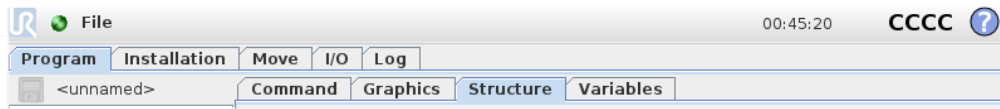

In this example, the **Program** tab is selected at the top level, and under that the **Structure** tab is selected. The **Program** tab holds information related to the currently loaded program. If the **Move** tab is selected, the screen changes to the **Move** screen, from where the robot arm can be moved. Similarly, by selecting the **I/O** tab, the current state of the electrical I/O can be monitored and changed.

It is possible to connect a mouse and a keyboard to the control box or the teach pendant; however, this is not required. Almost all text fields are touch-enabled, so touching them launches an on-screen keypad or keyboard.

The various screens of PolyScope are described in the following sections.

11.4 Welcome Screen

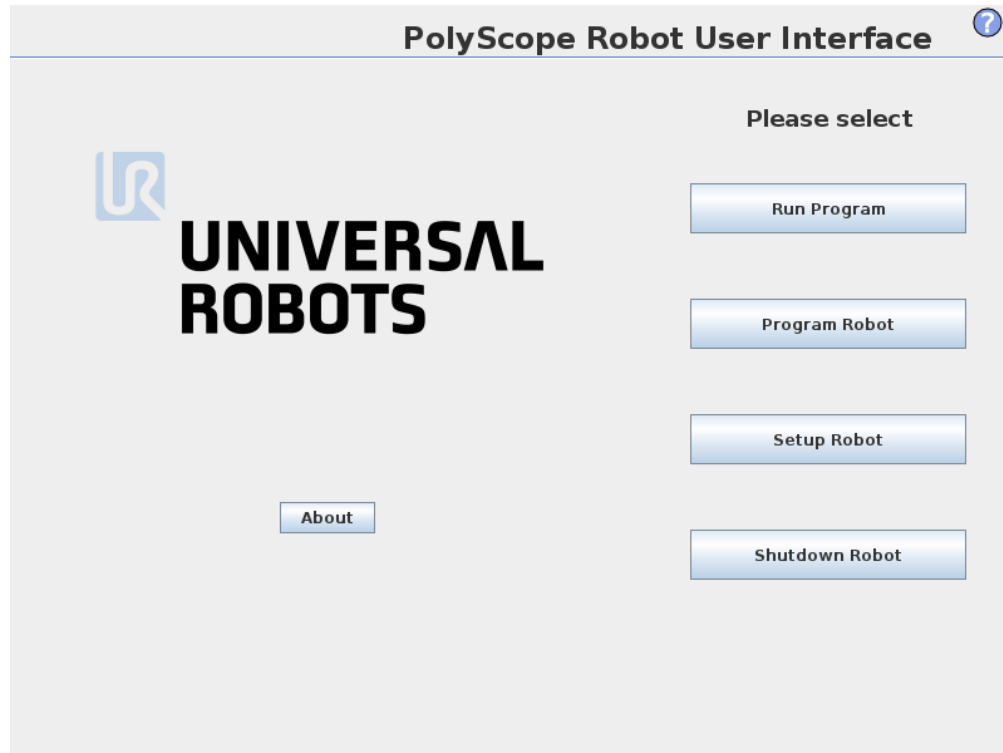

After booting up the controller PC, the welcome screen is shown. The screen offers the following options:

- **Run Program:** Choose and run an existing program. This is the simplest way to operate the robot arm and control box.
- **Program Robot:** Change a program, or create a new program.
- **Setup Robot:** Change the language, set passwords, upgrade software, etc.
- **Shutdown Robot:** Powers off the robot arm and shuts down the control box.
- **About:** Provides details related to software versions, hostname, IP address, serial number and legal information.

11.5 Initialization Screen

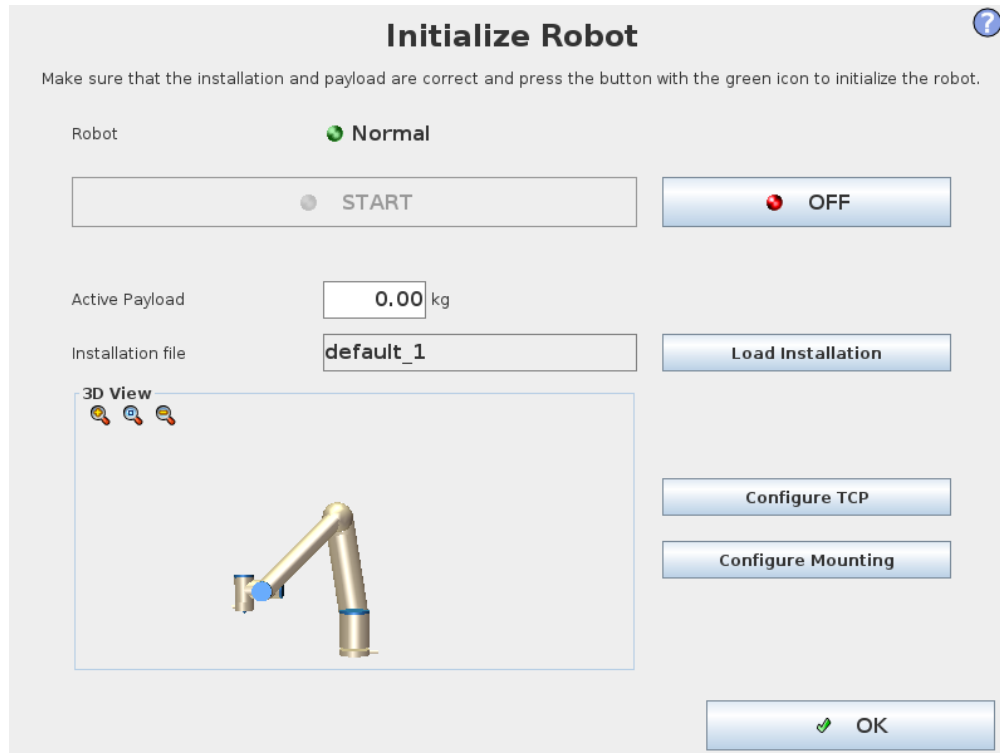

On this screen you control the initialization of the robot arm.

Robot arm state indicator

The status LED gives an indication of the robot arm's running state:

- A bright red LED indicates that the robot arm is currently in a stopped state where the reasons can be several.
- A bright yellow LED indicates that the robot arm is powered on, but is not ready for normal operation.
- Finally, a green LED indicates that the robot arm is powered on, and ready for normal operation.

The text appearing next to the LED further specifies the current state of the robot arm.

Active payload and installation

When the robot arm is powered on, the payload mass used by the controller when operating the robot arm is shown in the small white text field. This value can be modified by tapping the text field and entering a new value.

Note: setting this value does not modify the payload in the robot's installation (see 13.6), it only sets the payload mass to be used by the controller.

Similarly, the name of the installation file that is currently loaded is shown in the grey text field. A different installation can be loaded by tapping the text field or by using the **Load** button next to it. Alternatively, the loaded installation can be customized using the buttons next to the 3D view in the lower part of the screen.

Before starting up the robot arm, it is very important to verify that both the active payload and the active installation correspond to the actual situation the robot arm is currently in.

Initializing the robot arm



DANGER:

Always verify that the actual payload and installation are correct before starting up the robot arm. If these settings are wrong, the robot arm and control box will not function correctly and may become dangerous to people or equipment around them.



CAUTION:

Great care should be taken if the robot arm is touching an obstacle or table, since driving the robot arm into the obstacle might damage a joint gearbox.

The large button with the green icon on it serves to perform the actual initialization of the robot arm. The text on it, and the action it performs, change depending on the current state of the robot arm.

- After the controller PC boots up, the button needs to be tapped once to power the robot arm on. The robot arm state then turns to **Power on** and subsequently to **Idle**. Note that when an emergency stop is in place, the robot arm cannot be powered on, so the button will be disabled.
- When the robot arm state is **Idle**, the button needs to be tapped once again to start the robot arm up. At this point, sensor data is checked against the configured mounting of the robot arm. If a mismatch is found (with a tolerance of 30°), the button is disabled and an error message is displayed below it.

If the mounting verification passes, tapping the button releases all joint brakes and the robot arm becomes ready for normal operation. Note that the robot makes a sound and moves a little while releasing the brakes.

- If the robot arm violates one of the safety limits after it starts up, it operates in a special **Recovery mode**. In this mode, tapping the button switches to a recovery move screen where the robot arm can be moved back within the safety limits.
- If a fault occurs, the controller can be restarted using the button.
- If the controller is currently not running, tapping the button starts it.

Finally, the smaller button with the red icon on it serves to power off the robot arm.

12 On-screen Editors

12.1 On-screen Expression Editor

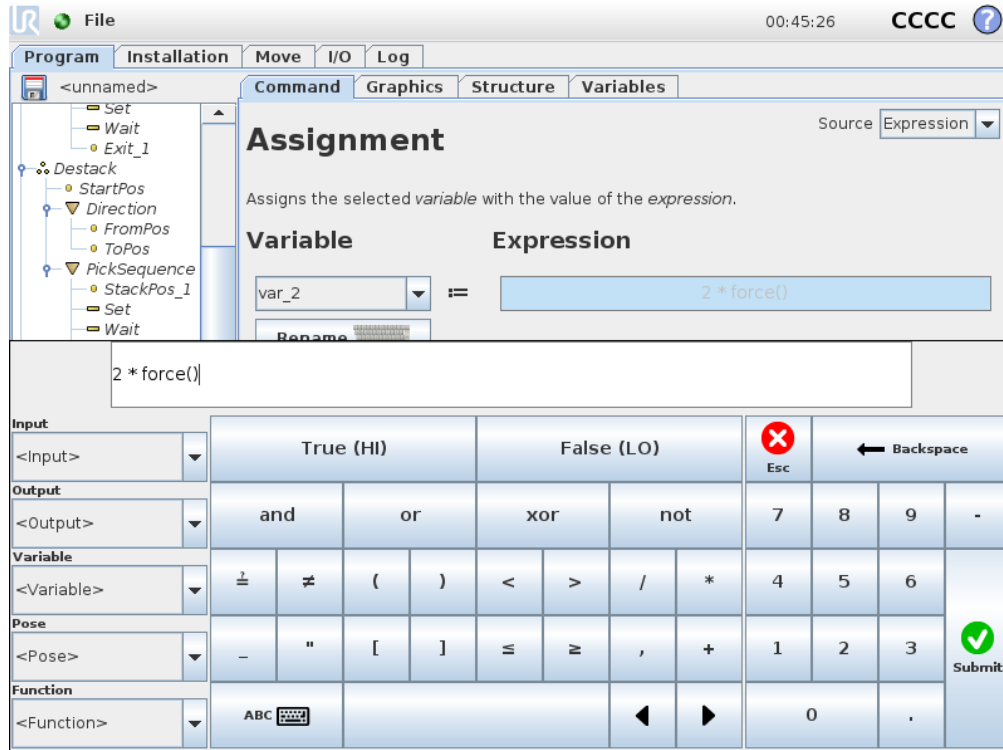

While the expression itself is edited as text, the expression editor has a number of buttons and functions for inserting the special expression symbols, such as * for multiplication and \leq for less than or equal to. The keyboard symbol button in the top left of the screen switches to text-editing of the expression. All defined variables can be found in the Variable selector, while the names of the input and output ports can be found in the Input and Output selectors. Some special functions are found in Function.

The expression is checked for grammatical errors when the Ok button is pressed. The Cancel button leaves the screen, discarding all changes.

An expression can look like this:

```
digital_in[1] = True and analog_in[0] < 0.5
```

12.2 Pose Editor Screen

On this screen you can specify target joint positions, or a target pose (position and orientation) of the robot tool. This screen is “offline” and does not control the robot arm directly.

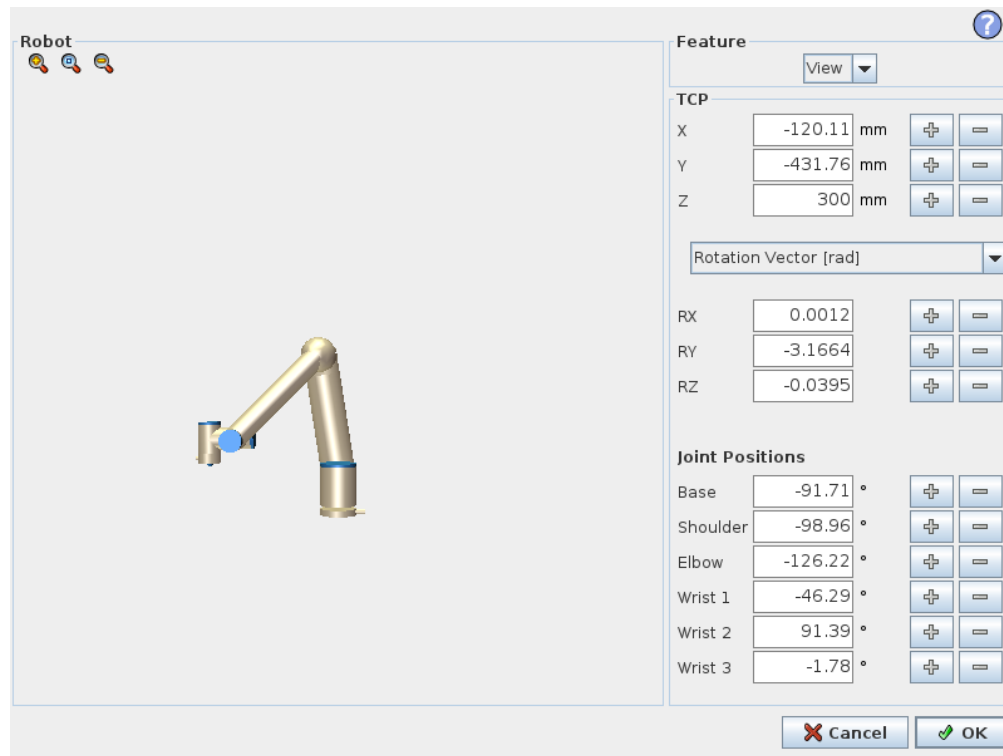

Robot

The current position of the robot arm and the specified new target position are shown in 3D graphics. The 3D drawing of the robot arm shows the current position of the robot arm, and the “shadow” of the robot arm shows the target position of the robot arm controlled by the specified values on the right hand side of the screen. Push the magnifying glass icons to zoom in/out or drag a finger across to change the view.

If the specified target position of the robot TCP is close to a safety or trigger plane, or the orientation of robot tool is near the tool orientation boundary limit (see 10.12), a 3D representation of the proximate boundary limit is shown.

Safety planes are visualized in yellow and black with a small arrow representing the plane normal, which indicates the side of the plane on which the robot TCP is allowed to be positioned. Trigger planes are displayed in blue and green and a small arrow pointing to the side of the plane, where the *Normal* mode limits (see 10.6) are active. The tool orientation boundary limit is visualized with a spherical cone together with a vector indicating the current orientation of the robot tool. The inside of the cone represents the allowed area for the tool orientation (vector).

When the target robot TCP no longer is in the proximity of the limit, the 3D representation disappears. If the target TCP is in violation or very close to violating a boundary limit, the visualization of the limit turns red.

Feature and tool position

In the top right corner of the screen, the feature selector can be found. The feature selector defines which feature to control the robot arm relative to

12.2 Pose Editor Screen

Below the feature selector, the name of the currently active Tool Center Point (TCP) is displayed. For further information about configuring several named TCPs, see 13.6. The text boxes show the full coordinate values of that TCP relative to the selected feature. X, Y and Z control the position of the tool, while RX, RY and RZ control the orientation of the tool.

Use the drop down menu above the RX, RY and RZ boxes to choose the orientation representation. Available types are:

- **Rotation Vector [rad]** The orientation is given as a *rotation vector*. The length of the axis is the angle to be rotated in radians, and the vector itself gives the axis about which to rotate. This is the default setting.
- **Rotation Vector [°]** The orientation is given as a *rotation vector*, where the length of the vector is the angle to be rotated in degrees.
- **RPY [rad]** *Roll, pitch and yaw (RPY)* angles, where the angles are in radians. The RPY-rotation matrix (X, Y, Z" rotation) is given by:

$$R_{rpy}(\gamma, \beta, \alpha) = R_Z(\alpha) \cdot R_Y(\beta) \cdot R_X(\gamma)$$

- **RPY [°]** *Roll, pitch and yaw (RPY)* angles, where angles are in degrees.

Values can be edited by clicking on the coordinate. Clicking on the + or – buttons just to the right of a box allows you to add or subtract an amount to/from the current value. Pressing and holding down a button will directly increase/decrease the value. The longer the button is down, the larger the increase/decrease will be.

Joint positions

Allows the individual joint positions to be specified directly. Each joint position can have a value in the range from -360° to $+360^\circ$, which are the *joint limits*. Values can be edited by clicking on the joint position. Clicking on the + or – buttons just to the right of a box allows you to add or subtract an amount to/from the current value. Pressing and holding down a button will directly increase/decrease the value. The longer the button is down, the larger the increase/decrease will be.

OK button

If this screen was activated from the `MOVE` tab (see 13.1), clicking the `OK` button will return to the `MOVE` tab, where the robot arm will move to the specified target. If the last specified value was a tool coordinate, the robot arm will move to the target position using the *MoveL* movement type, while the robot arm will move to the target position using the *MoveJ* movement type, if a joint position was specified last. The different movement types are described in 14.4.

Cancel button

Clicking the `Cancel` button leaves the screen discarding all changes.

Copyright © 2009–2019 by Universal Robots A/S. All rights reserved.

13 Robot Control

13.1 Move Tab

On this screen you can always move (jog) the robot arm directly, either by translating/rotating the robot tool, or by moving robot joints individually.

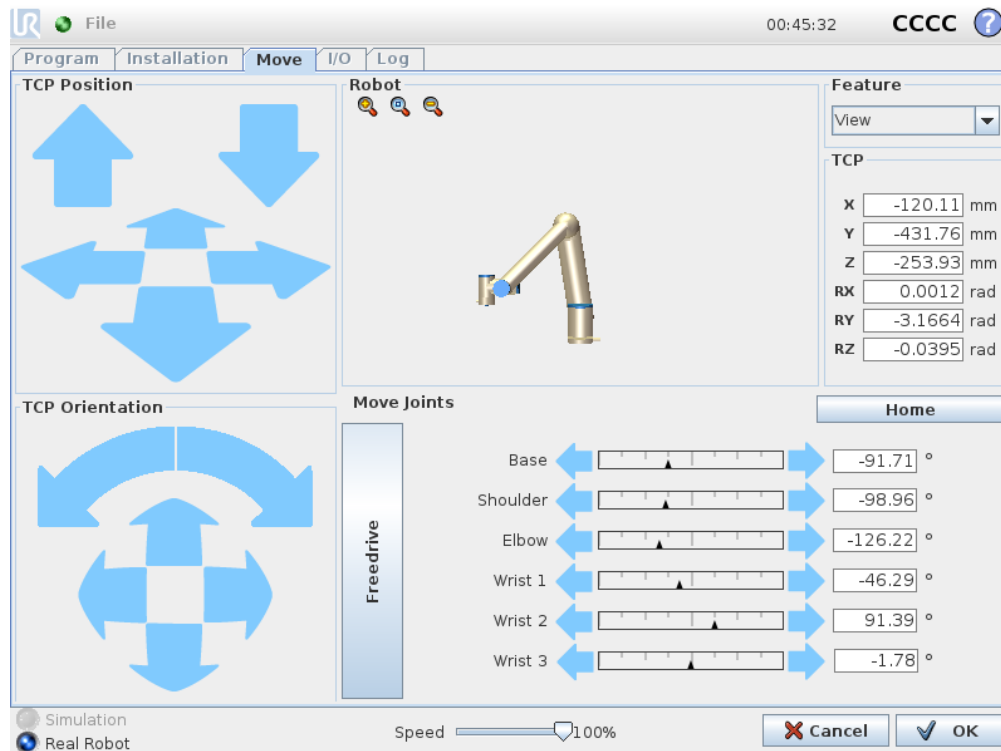

13.1.1 Robot

The current position of the robot arm is shown in 3D graphics. Push the magnifying glass icons to zoom in/out or drag a finger across to change the view. To get the best feel for controlling the robot arm, select the **View** feature and rotate the viewing angle of the 3D drawing to match your view of the real robot arm.

If the current position of the robot TCP comes close to a safety or trigger plane, or the orientation of robot tool is near the tool orientation boundary limit (see 10.12), a 3D representation of the proximate boundary limit is shown. Note that when the robot is running a program, the visualization of boundary limits will be disabled.

Safety planes are visualized in yellow and black with a small arrow representing the plane normal, which indicates the side of the plane on which the robot TCP is allowed to be positioned. Trigger planes are displayed in blue and green and a small arrow pointing to the side of the plane, where the **Normal** mode limits (see 10.6) are active. The tool orientation boundary limit is visualized

with a spherical cone together with a vector indicating the current orientation of the robot tool. The inside of the cone represents the allowed area for the tool orientation (vector).

When the robot TCP no longer is in the proximity of the limit, the 3D representation disappears. If the TCP is in violation or very close to violating a boundary limit, the visualization of the limit turns red.

13.1.2 Feature and Tool Position

In the top right corner of the screen, the feature selector can be found. It defines which feature to control the robot arm relative to.

The name of the currently active Tool Center Point (TCP) is displayed below the feature selector. The text boxes show the full coordinate values of that TCP relative to the selected feature. For further information about configuring several named TCPs, (see 13.6).

Values can be edited manually by clicking on the coordinate or the joint position. This will take you to the pose editor screen (see 12.2) where you can specify a target position and orientation for the tool or target joint positions.

13.1.3 Move Tool

- Holding down a `translate` arrow (top) will move the tool-tip of the robot in the direction indicated.
- Holding down a `rotate` arrow (bottom) will change the orientation of the robot tool in the indicated direction. The point of rotation is the Tool Center Point (TCP), i.e. the point at the end of the robot arm that gives a characteristic point on the robot's tool. The TCP is shown as a small blue ball.

Note: Release the button to stop the motion at any time

13.1.4 Move Joints

Allows the individual joints to be controlled directly. Each joint can move from -360° to $+360^\circ$, which are the default *joint limits* illustrated by the horizontal bar for each joint. If a joint reaches its joint limit, it cannot be driven any further. If the limits for a joint have been configured with a position range different from the default (see 10.11), this range is indicated with red in the horizontal bar.

13.1.5 Freedrive

While the *Freedrive* button is held down, it is possible to physically grab the robot arm and pull it to where you want it to be. If the gravity setting (see 13.7) in the **Setup** tab is wrong, or the robot arm carries a heavy load, the robot arm might start moving (falling) when the **Freedrive** button is pressed. In that case, just release the **Freedrive** button again.

**WARNING:**

1. Make sure to use the correct installation settings (e.g. Robot mounting angle, weight in TCP, TCP offset). Save and load the installation files along with the program.
2. Make sure that the TCP settings and the robot mounting settings are set correctly before operating the **Freedrive** button. If these settings are not correct, the robot arm will move when the **Freedrive** button is activated.
3. The Freedrive function (**Impedance/Backdrive**) shall only be used in installations where the risk assessment allows it. Tools and obstacles shall not have sharp edges or pinch points. Make sure that all personnel remain outside the reach of the robot arm.

13.2 I/O Tab

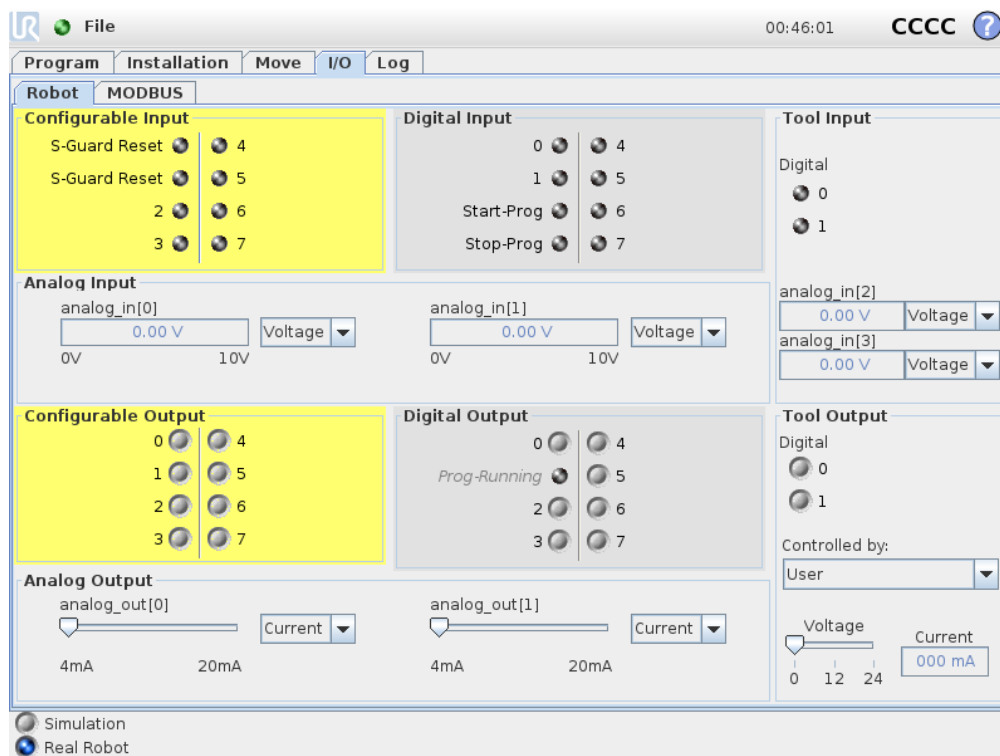

On this screen you can always monitor and set the live I/O signals from/to the robot control box. The screen displays the current state of the I/O, including during program execution. If anything is changed during program execution, the program will stop. At program stop, all output signals will retain their states. The screen is updated at only 10Hz, so a very fast signal might not display properly.

Configurable I/O's can be reserved for special safety settings defined in the safety I/O configuration section of the installation (see 10.13); those which are reserved will have the name of the safety function in place of the default or user defined name. Configurable outputs that are reserved for safety settings are not toggleable and will be displayed as LED's only.

The electrical details of the signals are described in chapter 5.3.

Voltage In Tool Output, Voltage can be configured only when Tool Output is controlled by the User. Selecting a URCap removes access to the Voltage.

Analog Domain Settings The analog I/O's can be set to either current [4-20mA] or voltage [0-10V] output. The settings will be remembered for eventual later restarts of the robot controller when a program is saved. Selecting a URCap, in Tool Output, removes access to the Domain Settings for the analog Tool Inputs.

13.3 MODBUS

The screenshot below displays the MODBUS client I/O signals as they are set up in the installation. Using the drop-down menus at the top of the screen, you can change the displayed content based on signal type and MODBUS unit if more than one is configured. Each signal in the lists contains its connections status, value, name, and signal address. The output signals can be toggled if the connection status and the choice for I/O tab control allows it (see 13.8).

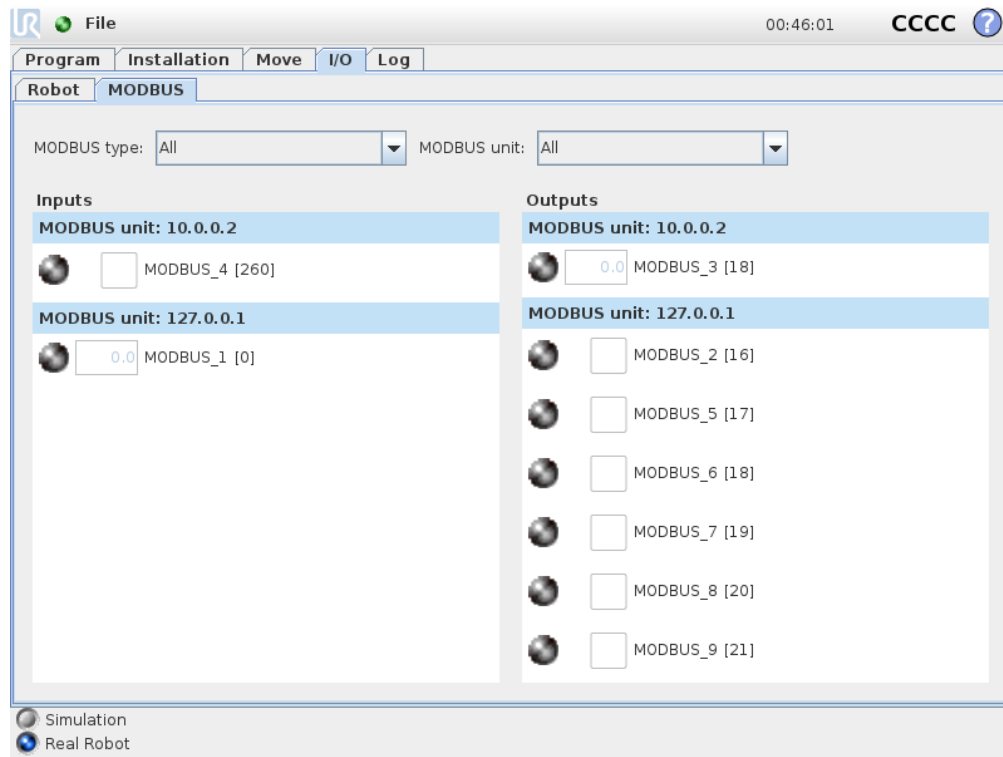

Copyright © 2009–2019 by Universal Robots A/S. All rights reserved.

13.4 AutoMove Tab

The AutoMove tab is used when the robot arm has to move to a specific position in its workspace. Examples are when the robot arm has to move to the start position of a program before running it, or when moving to a waypoint while modifying a program.

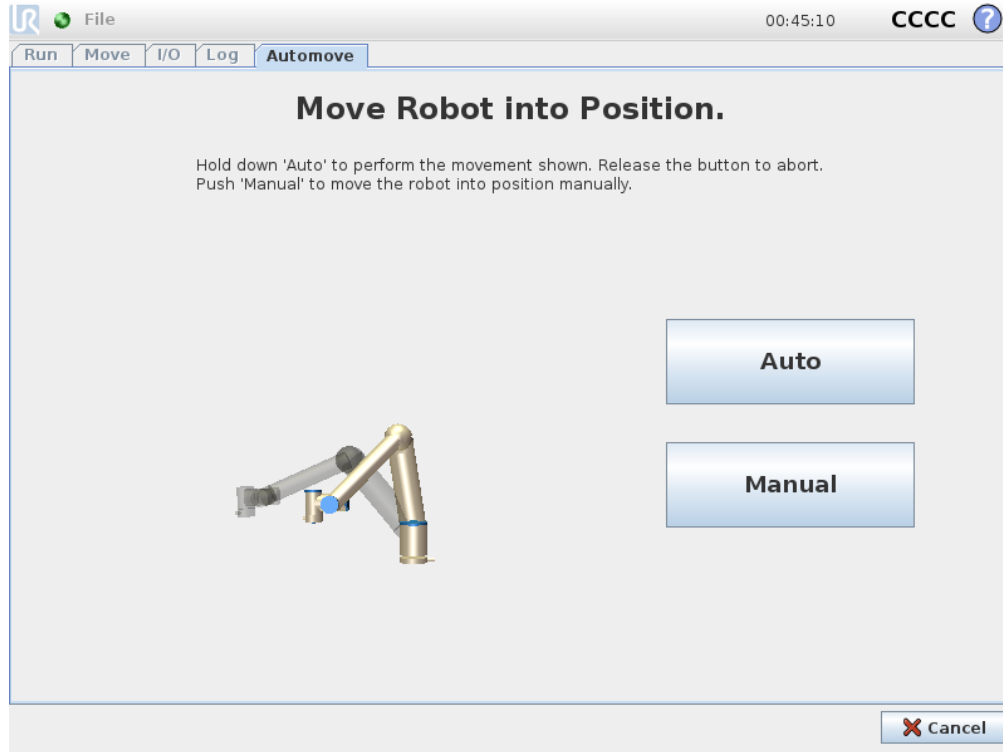

Animation

The animation shows the movement the robot arm is about to perform.



CAUTION:

Compare the animation with the position of the real robot arm and make sure that the robot arm can safely perform the movement without hitting any obstacles.



CAUTION:

The automove function moves along the robot along the shadow trajectory. Collision might damage the robot or other equipment.

Auto

Hold down the **Auto** button to move the robot arm as shown in the animation.

Note: Release the button to stop the motion at any time.

Manual

Pushing the **Manual** button will take you to the **Move** tab where the robot arm can be moved manually. This is only needed if the movement in the animation is not preferable.

13.5 Installation → Load/Save

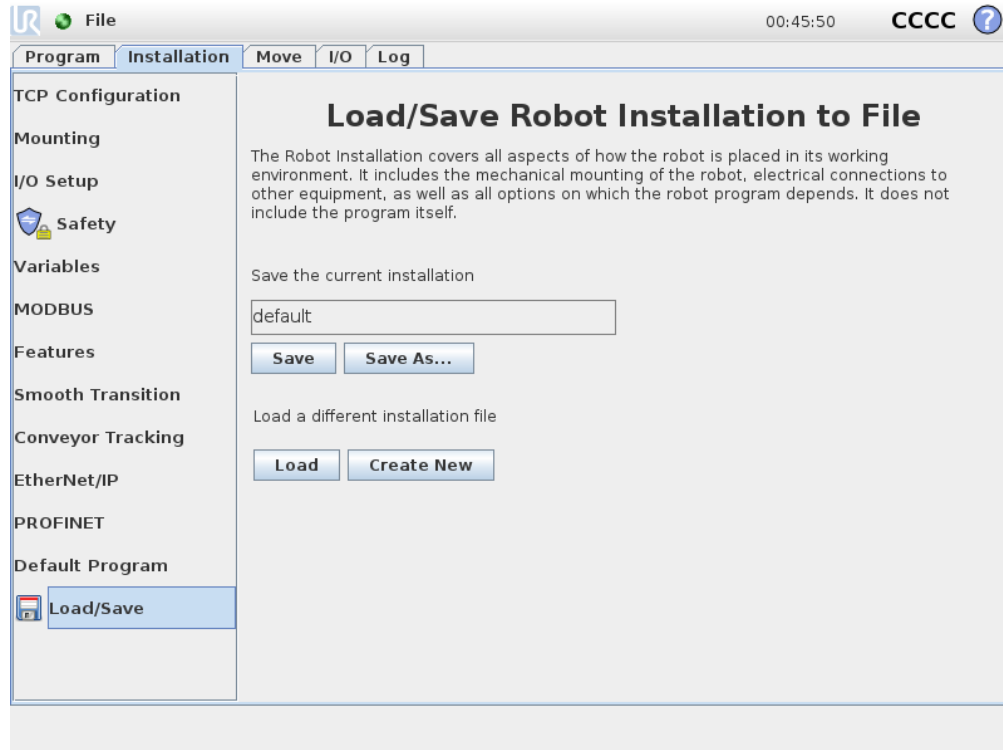

The Robot Installation covers all aspects of how the robot arm and control box are placed in the working environment. It includes the mechanical mounting of the robot arm, electrical connections to other equipment, as well as all options on which the robot program depends. It does not include the program itself.

These settings can be set using the various screens under the **Installation** tab, except for the I/O domains which are set in the **I/O** tab (see 13.2).

It is possible to have more than one installation file for the robot. Programs created will use the active installation, and will load this installation automatically when used.

Any changes to an installation need to be saved to be preserved after power down. If there are unsaved changes in the installation, a floppy disk icon is shown next to the **Load/Save** text on the left side of the **Installation** tab.

Saving an installation can be done by pressing the **Save** or **Save As...** button. Alternatively, saving a program also saves the active installation. To load a different installation file, use the **Load** button. The **Create New** button resets all of the settings in the Robot Installation to their factory defaults.

**CAUTION:**

Using the robot with an installation loaded from a USB drive is not recommended. To use an installation stored on a USB drive, first load it and then save it in the local **programs** folder using the **Save As...** button.

13.6 Installation → TCP Configuration

A **Tool Center Point (TCP)** is a point on the robot's tool. Each TCP contains a translation and a rotation relative to the center of the tool output flange.

When programmed to return to a previously stored waypoint, a robot moves the TCP to the position and orientation saved within the waypoint. When programmed for linear motion, the TCP moves linearly.

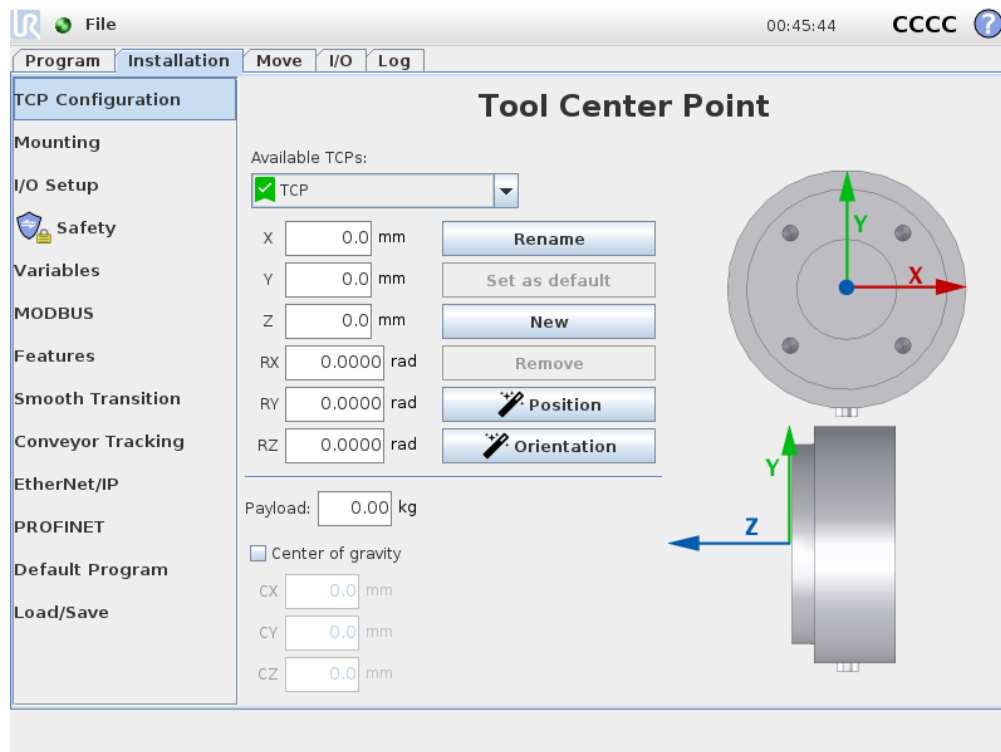

Position

The X , Y , Z coordinates specify the TCP position. When all values (including orientation) are zero, the TCP coincides with the center point of the tool output flange and adopts the coordinate system depicted on the screen.

Orientation

The RX , RY , RZ coordinate boxes specify the TCP orientation. Similar to the Move Tab, use the Units drop down menu above the RX , RY , RZ boxes to select the orientation coordinates (see 12.2).

13.6.1 Adding, renaming, modifying and removing TCPs

Tap the **New** button to define a new TCP. The created TCP automatically receives a unique name and becomes selectable in the drop-down menu. To rename a TCP, tap the **Rename** button. To remove the selected TCP, tap the **Remove** button. The last TCP cannot be removed.

The translation and rotation of a selected TCP can be modified by entering new values into the fields.

13.6.2 Active TCP

When moving linearly, the robot always uses the active TCP to determine the TCP offset. The active TCP can be changed using a Move command (see 14.4) or a Set command.

13.6.3 Default TCP

The Default TCP must be set as the active TCP before running a program. Select the desired TCP and tap **Set as default** to set a TCP as the default. The green icon in the available drop-down menu indicates the default configured TCP.

13.6.4 Teaching TCP position

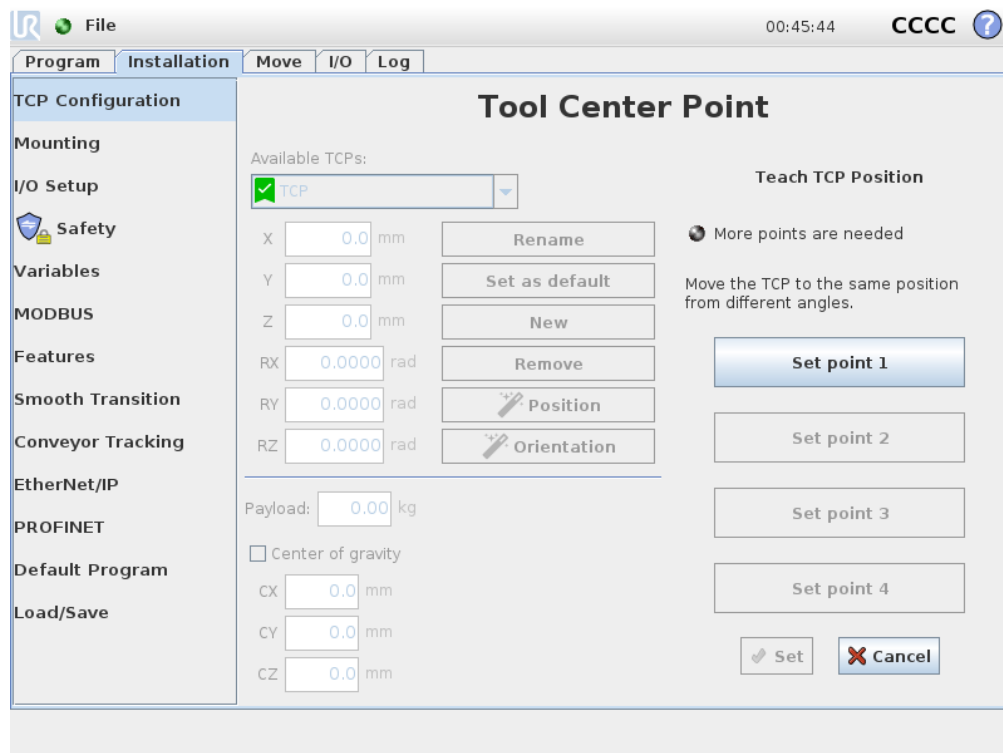

TCP position coordinates can be calculated automatically as follows:

1. Tap the **TCP Position Wizard**.
2. Choose a fixed point in the workspace of the robot.

13.6 Installation → TCP Configuration

3. Use the position arrows on the right side of the screen to move the TCP from at least three different angles and to save the corresponding positions of the tool output flange.
4. Use the **Set** button to apply the verified coordinates to the appropriate TCP. The positions must be sufficiently diverse for the calculation to work correctly. If they are not sufficiently diverse, the status LED above the buttons turns red.

Though three positions are sufficient to determine the TCP, a fourth position can be used to further verify the calculation is correct. The quality of each saved point, with respect to the calculated TCP, is indicated using a green, yellow, or red LED on the corresponding button.

13.6.5 Teaching TCP orientation

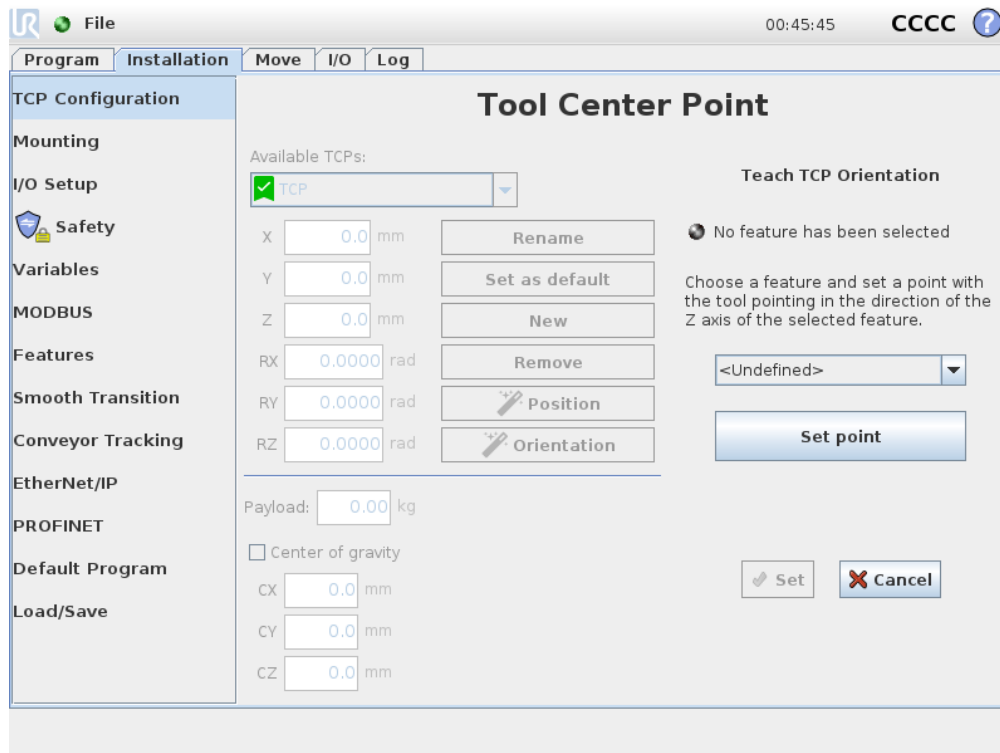

1. Tap the **TCP Orientation Wizard**.
2. Select a feature from the drop-down list. (See 13.12) for additional information on defining new features
3. Tap **Select point** and use **Move tool arrows** to a position where the tool's orientation and the corresponding TCP coincide with the selected features's coordinate system.
4. Verify the calculated TCP orientation and apply it to the selected TCP by tapping **Set**.

13.6.6 Payload

The weight of the robot's tool is specified in the lower part of the screen. To change this setting, simply tap the white text field and enter a new weight. The setting applies to all defined TCPs. For details about the maximum allowed payload, see the Hardware Installation Manual.

13.6.7 Center of gravity

The tool's center of gravity is specified using the fields CX, CY and CZ. The settings apply to all defined TCPs. Installations created before version 3.8 support the center of gravity being set to the TCP if they were previously set. If the center of gravity is manually set, in 3.8 or higher, the ability to set the center of gravity for the TCP is permanently removed.



WARNING:

Use the correct installation settings. Save and load the installation files with the program.

13.7 Installation → Mounting

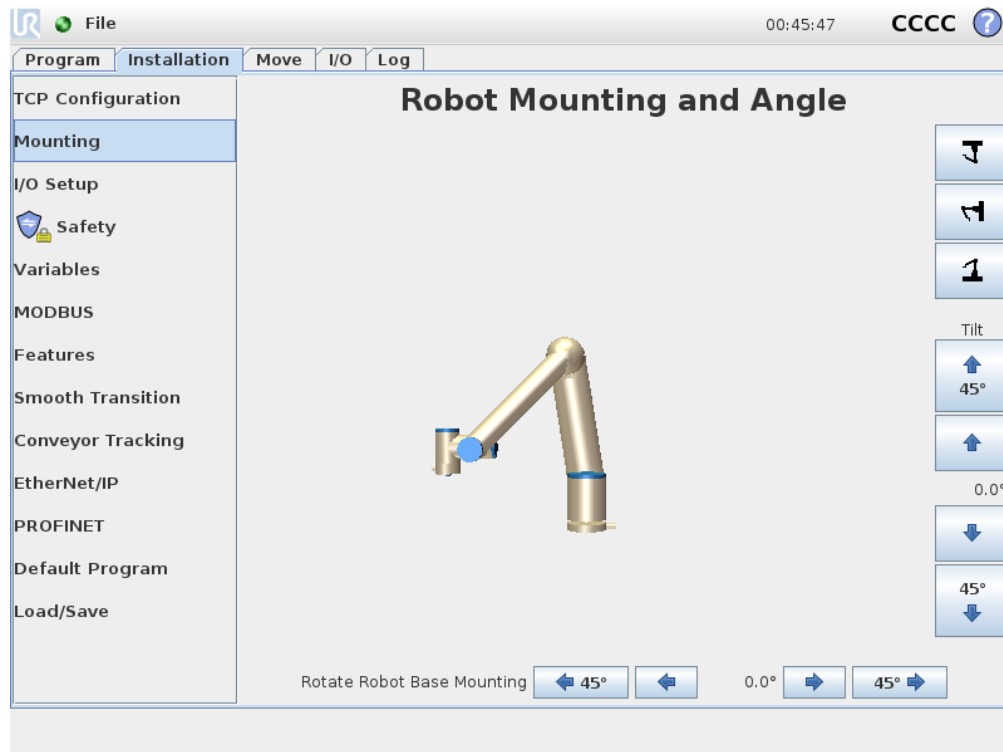

Copyright © 2009–2019 by Universal Robots A/S. All rights reserved.

Specifying the mounting of the Robot arm serves two purposes:

1. Making the Robot arm appear correctly on screen.
2. Telling the controller about the direction of gravity.

An advanced dynamics model gives the Robot arm smooth and precise motions, as well as allows the Robot arm to hold itself in **Freedrive Mode**. For this reason, it is important to mount the Robot arm correctly.



WARNING:

Failure to mount the Robot’s arm correctly may result in frequent Protective Stops, and/or the Robot arm will move when pressing the **Freedrive** button.

If the Robot arm is mounted on a flat table or floor, no change is needed on this screen. However, if the Robot arm is **ceiling mounted**, **wall mounted**, or **mounted at an angle**, this needs to be adjusted using the buttons.

The buttons on the right side of the screen are for setting the angle of the Robot arm’s mounting. The top three right side buttons set the angle to **ceiling** (180°), **wall** (90°), **floor** (0°). The **Tilt** buttons set an arbitrary angle.

The buttons on the lower part of the screen are used to rotate the mounting of the Robot arm to match the actual mounting.



WARNING:

Use the correct installation settings. Save and load the installation files with the program.

13.8 Installation → I/O Setup

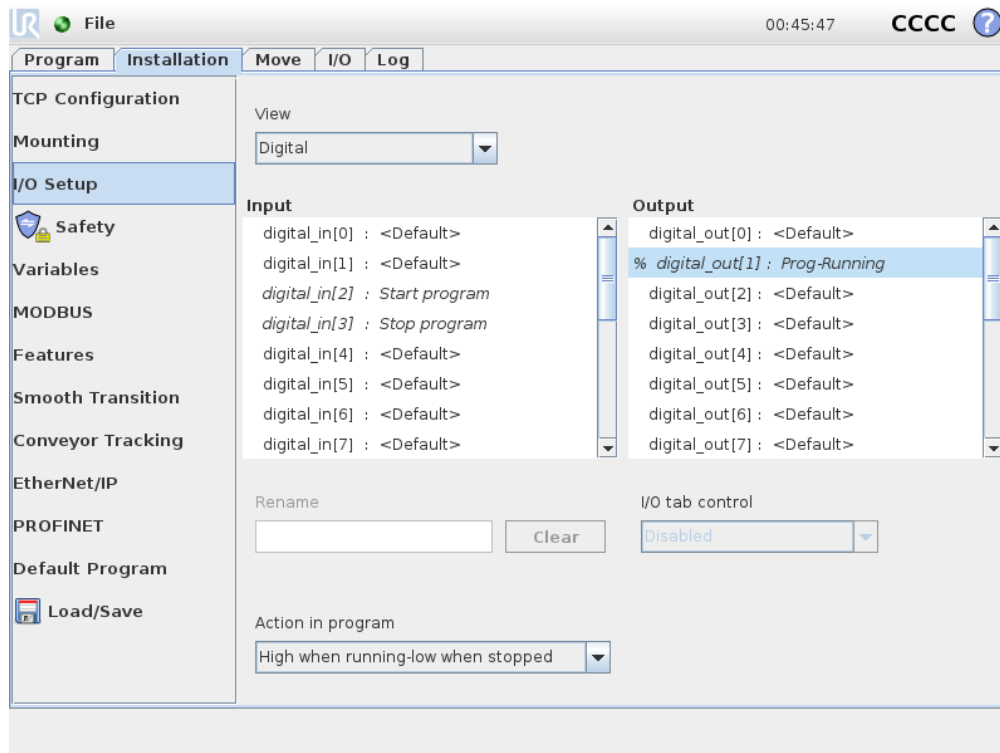

Copyright © 2009–2019 by Universal Robots A/S. All rights reserved.

On the I/O Setup screen, users can define I/O signals and configure actions with the I/O tab control.

The **Input** and **Output** sections list types of I/O signals such as:

- Digital standard general purpose, configurable and tool
- Analog standard general purpose and tool
- MODBUS
- General purpose registers (boolean, integer and float) The general purpose registers can be accessed by a fieldbus (e.g., Profinet and EtherNet/IP).

13.8.1 I/O Signal Type

To limit the number of signals listed in the **Input** and **Output** sections, use the **View** drop-down menu at the top of the screen to change the displayed content based on signal type.

13.8.2 Assigning User-defined Names

To easily remember what the signals do while working with the robot, users can associate names to Input and Output signals.

1. Select the desired signal
2. Tap the text field in the lower part of the screen to set the name.
3. To reset the name to default, tap **Clear**.

A general purpose register must be given a user-defined name to make it available in the program (i.e., for a **Wait** command or the conditional expression of an **If** command) The **Wait** and **If** commands are described in (14.10) and (14.17), respectively. Named general purpose registers can be found in the **Input** or **Output** selector on the **Expression Editor** screen.

13.8.3 I/O Actions and I/O Tab Control

Input and Output Actions: Physical and Fieldbus digital I/Os can be used to trigger actions or react to the status of a program.

Available Input Actions:

- Start: starts or resumes the current program on a rising edge.
- Stop: Stops the current program on a rising edge.
- Pause: Pauses the current program on a rising edge.
- Freedrive: When the input is high, the robot is in freedrive (similar to the freedrive button). The input is ignored if a program is running or other conditions disallow freedrive.



WARNING:

If the robot is stopped while using the Start input action, the robot slowly moves to the first waypoint of the program before executing that program. If the robot is paused while using the Start input action, the robot slowly moves to the position from where it was paused before resuming that program.

Available Output Actions:

- Low when not running: Output is low when the program state is “stopped” or “paused”.
- High when not running: Output is high when the program state is “stopped” or “paused”.
- High when running, low when stopped: Output is low when the program state is “stopped” or “paused” and high when it is running.
- Continuous Pulse: Output alternates between high and low for a specified number of seconds, while the program is running. Pause or stop the program to maintain the pulse state.

I/O Tab Control: Specify whether an output is controlled on the I/O tab (by either programmers, or both operators and programmers), or if it is controlled by the robot programs.

13.9 Installation → Safety

See chapter 10.

13.10 Installation → Variables

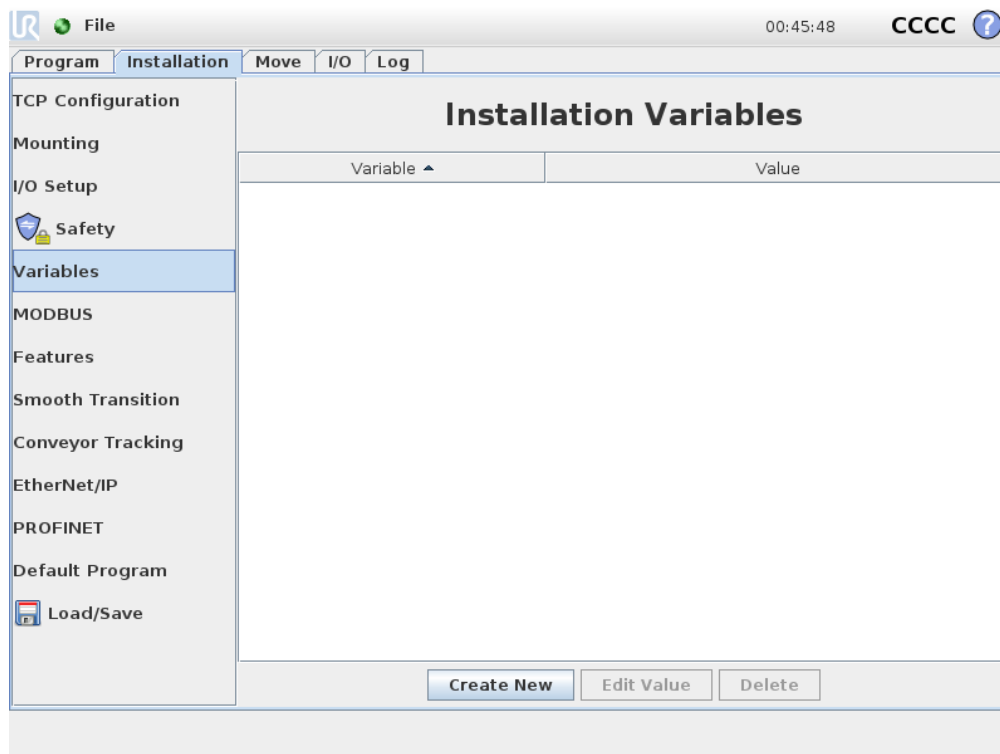

Variables created on the Variables screen are called Installation Variables and are used like normal program variables. Installation Variables are distinct because they keep their value even if a program stops and then starts again, and when the Robot arm and/or Control Box is powered down and powered up again. Their names and values are stored with the installation, therefore it is possible to use the same variable in multiple programs.

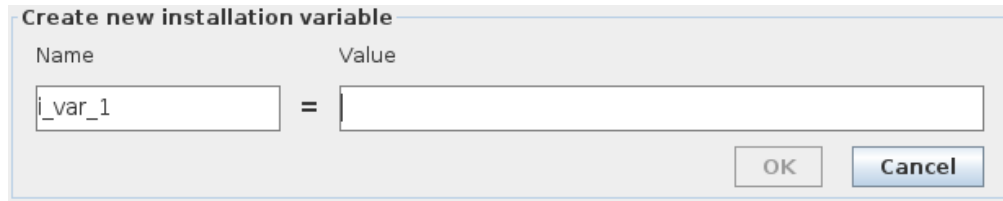

Pressing **Create New** brings up a panel with a suggested name for the new variable. The name may be changed and its value may be entered by touching either text field. The **OK**-button can only be tapped if the new name is unused in this installation.

It is possible to change the value of an installation variable by highlighting the variable in the list and then clicking on **Edit Value**.

To delete a variable, select it and tap **Delete**.

After configuring the installation variables, the installation itself must be saved to keep the configuration.

The installation variables and their values are saved automatically every 10 minutes.

If a program or an installation is loaded and one or more of the program variables have the same name as the installation variables, the user is presented with options to either resolve the issue using the installation variables of the same name instead of the program variable or resolve the issue by having the conflicting variables renamed automatically.

13.11 Installation → MODBUS client I/O Setup

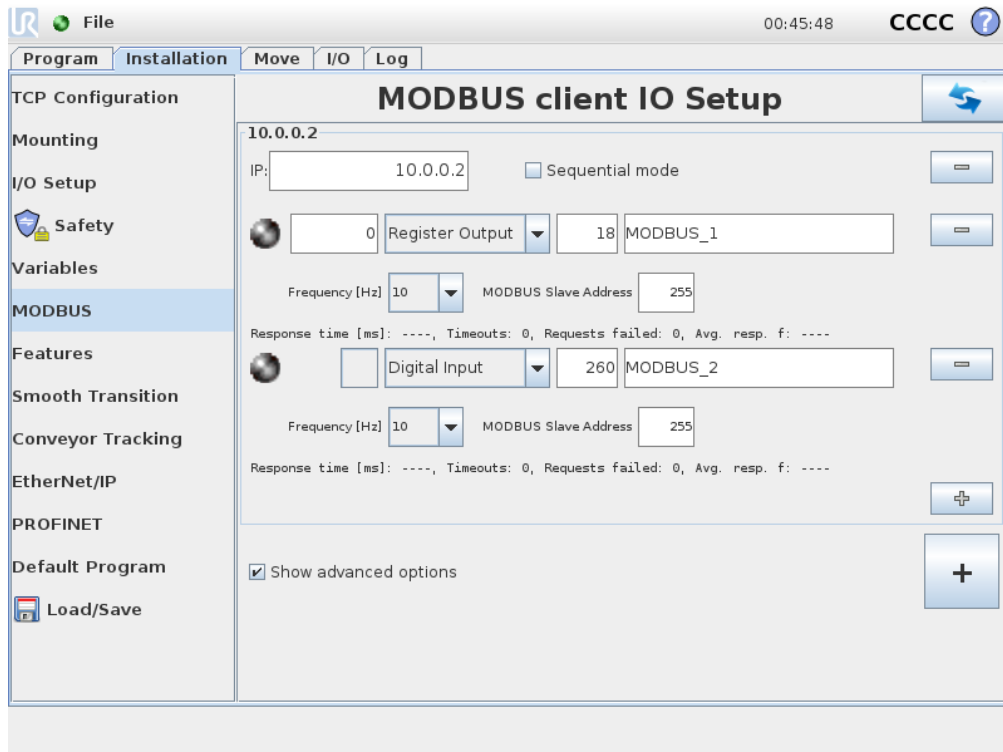

13.11 Installation → MODBUS client I/O Setup

Here, the MODBUS client (master) signals can be set up. Connections to MODBUS servers (or slaves) on specified IP addresses can be created with input/output signals (registers or digital). Each signal has a unique name so it can be used in programs.

Refresh

Push this button to refresh all MODBUS connections. Refreshing disconnects all modbus units, and connects them back again. All statistics are cleared.

Add unit

Push this button to add a new MODBUS unit.

Delete unit

Push this button to delete the MODBUS unit and all signals on that unit.

Set unit IP

Here the IP address of the MODBUS unit is shown. Press the button to change it.

Sequential mode

Available only when Show Advanced Options (see 13.11) is selected. Selecting this checkbox forces the modbus client to wait for a response before sending the next request. This mode is required by some fieldbus units. Turning this option on may help when there are multiple signals, and increasing request frequency results in signal disconnects. Note that the actual signal frequency may be lower than requested when multiple signals are defined in sequential mode. Actual signal frequency can be observed in signal statistics (see section 13.11). The signal indicator will turn yellow if the actual signal frequency is less than half of the value selected from the "Frequency" drop-down list.

Add signal

Push this button to add a signal to the corresponding MODBUS unit.

Delete signal

Push this button to delete a MODBUS signal from the corresponding MODBUS unit.

Set signal type

Use this drop down menu to choose the signal type. Available types are:

Digital input: A digital input (coil) is a one-bit quantity which is read from the MODBUS unit on the coil specified in the address field of the signal. Function code 0x02 (Read Discrete Inputs) is used.

Digital output: A digital output (coil) is a one-bit quantity which can be set to either high or low. Before the value of this output has been set by the user, the value is read from the remote MODBUS unit. This means that function code 0x01 (Read Coils) is used. When the output has

been set by a robot program or by pressing the **set signal value** button, the function code 0x05 (Write Single Coil) is used onwards.

Register input: A register input is a 16-bit quantity read from the address specified in the address field. The function code 0x04 (Read Input Registers) is used.

Register output: A register output is a 16-bit quantity which can be set by the user. Before the value of the register has been set, the value of it is read from the remote MODBUS unit. This means that function code 0x03 (Read Holding Registers) is used. When the output has been set by a robot program or by specifying a signal value in the **set signal value** field, function code 0x06 (Write Single Register) is used to set the value on the remote MODBUS unit.

Set signal address

This field shows the address on the remote MODBUS server. Use the on-screen keypad to choose a different address. Valid addresses depends on the manufacturer and configuration of the remote MODBUS unit.

Set signal name

Using the on-screen keyboard, the user can give the signal a name. This name is used when the signal is used in programs.

Signal value

Here, the current value of the signal is shown. For register signals, the value is expressed as an unsigned integer. For output signals, the desired signal value can be set using the button. Again, for a register output, the value to write to the unit must be supplied as an unsigned integer.

Signal connectivity status

This icon shows whether the signal can be properly read/written (green), or if the unit responds unexpected or is not reachable (gray). If a MODBUS exception response is received, the response code is displayed. The MODBUS-TCP Exception responses are:

- E1:* ILLEGAL FUNCTION (0x01) The function code received in the query is not an allowable action for the server (or slave).
- E2:* ILLEGAL DATA ADDRESS (0x02) The function code received in the query is not an allowable action for the server (or slave), check that the entered signal address corresponds to the setup of the remote MODBUS server.
- E3:* ILLEGAL DATA VALUE (0x03) A value contained in the query data field is not an allowable value for server (or slave), check that the entered signal value is valid for the specified address on the remote MODBUS server.
- E4:* SLAVE DEVICE FAILURE (0x04) An unrecoverable error occurred while the server (or slave) was attempting to perform the requested action.
- E5:* ACKNOWLEDGE (0x05) Specialized use in conjunction with programming commands sent to the remote MODBUS unit.

E6: SLAVE DEVICE BUSY (0x06) Specialized use in conjunction with programming commands sent to the remote MODBUS unit, the slave (server) is not able to respond now.

Show Advanced Options

This check box shows/hides the advanced options for each signal.

Advanced Options

Update Frequency: This menu can be used to change the update frequency of the signal. This means the frequency with which requests are sent to the remote MODBUS unit for either reading or writing the signal value. When the frequency is set to 0, then modbus requests are initiated on demand using a *modbus_get_signal_status*, *modbus_set_output_register*, and *modbus_set_output_signal* script functions.

Slave Address: This text field can be used to set a specific slave address for the requests corresponding to a specific signal. The value must be in the range 0-255 both included, and the default is 255. If you change this value, it is recommended to consult the manual of the remote MODBUS device to verify its functionality when changing slave address.

Reconnect count: Number of times TCP connection was closed, and connected again.

Connection status: TCP connection status.

Response time [ms:] Time between modbus request sent, and response received - this is updated only when communication is active.

Modbus packet errors: Number of received packets that contained errors (i.e. invalid length, missing data, TCP socket error).

Timeouts: Number of modbus requests that didn't get response.

Requests failed: Number of packets that could not be sent due to invalid socket status.

Actual freq.: The average frequency of client (master) signal status updates. This value is recalculated each time the signal receives a response from the server (or slave).

All counters count up to 65535, and then wrap back to 0.

13.12 Installation → Features

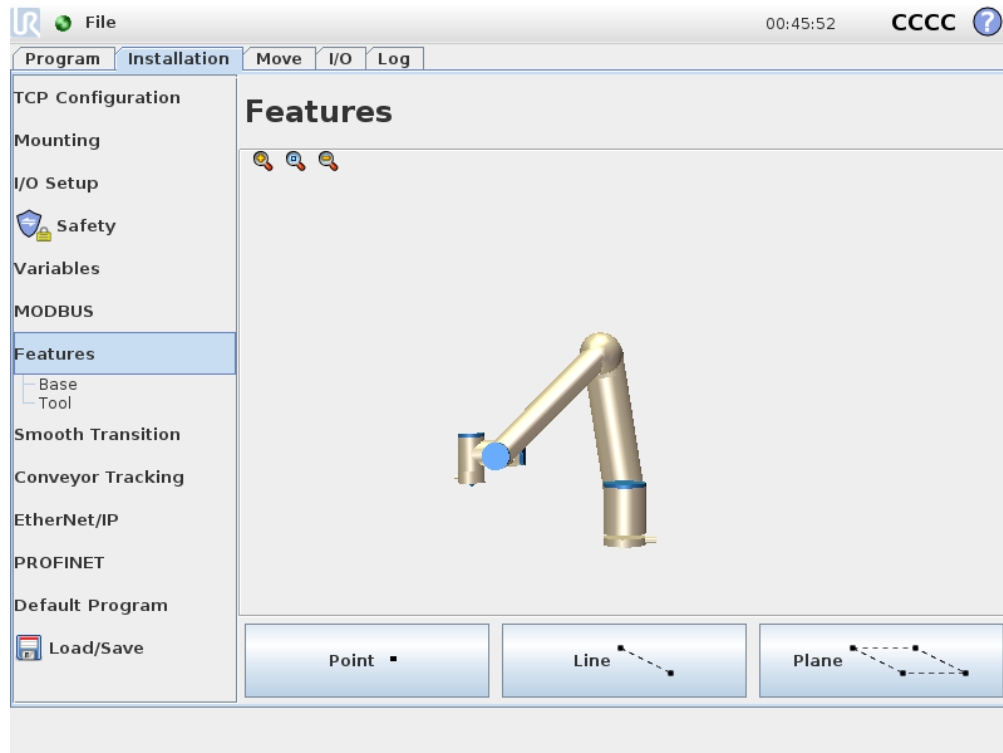

The **Feature**, is a representation of an object that is defined with a name for future reference and a six dimensional pose (position and orientation) relative to the robot base.

Some subparts of a robot program consist of movements executed relative to specific objects other than the base of the Robot arm. These objects could be tables, other machines, workpieces, conveyors, pallets, vision systems, blanks, or boundaries which exist in the surroundings of the Robot arm. Two predefined features always exist for the robot. Each feature has its pose defined by the configuration of the Robot arm itself:

- The Base feature is located with origin in the centre of the robot base (see figure 13.1)
- The Tool feature is located with origin in the centre of the current TCP (see figure 13.2)

User-defined features are positioned through a method that uses the current pose of the TCP in the work area. This means the users can teach feature locations using Freedrive Mode or “jogging” to move the robot to the desired pose.

Three different strategies exist (**Point**, **Line** and **Plane**) for defining a feature pose. The best strategy for a given application depends on the type of object being used and the precision requirements. In general a feature based on more input points (**Line** and **Plane**) is preferred if applicable to the specific object.

To accurately define the direction of a linear conveyor, define two points of a Line feature with as much physical separation as possible. The Point feature can also be used to define a linear conveyor,

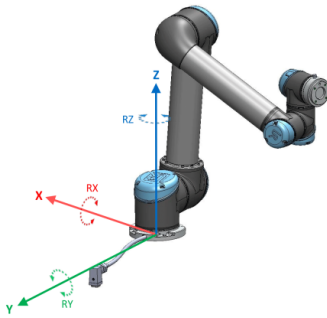

Figure 13.1: Base feature

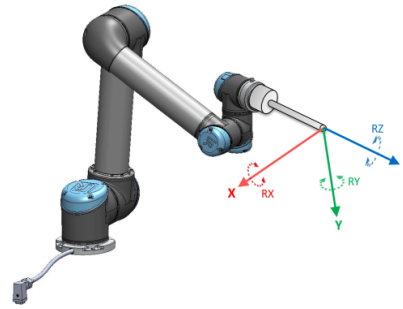

Figure 13.2: Tool (TCP) feature

however, the user must point the TCP in the direction of the conveyor movement.

Using more points to define the pose of a table means that the orientation is based on the positions rather than the orientation of a single TCP. A single TCP orientation is harder to configure with high precision.

To learn about the different methods to define a feature see (sections: 13.12.2), (13.12.3) and (13.12.4).

13.12.1 Using a feature

When a feature is defined in the installation, you can refer to it from the robot program to relate robot movements (e.g. **MoveL** and **MoveP** commands) to the feature (see section 14.4). This allows for easy adaptation of a robot program (e.g., when there are multiple robot stations, when an object is moved during program runtime, or when an object is permanently moved in the scene). By adjusting the feature of an object, all program movements relative to the object is moved accordingly. For further examples, see (sections 13.12.5) and (13.12.6). Features configured as joggable are also useful tools when manually moving the robot in the Move Tab (section 13.1) or the **Pose Editor** screen (see 12.2). When a feature is chosen as a reference, the Move Tool buttons for translation and rotation operate in the selected feature space (see 13.1.2) and (13.1.3), reading of the TCP coordinates. For example, if a table is defined as a feature and is chosen as a reference in the Move Tab, the translation arrows (i.e., up/down, left/right, forward/backward) move the robot in these directions relative to the table. Additionally, the TCP coordinates will be in the frame of the table.

Rename

This button renames a feature.

Delete

This button deletes a selected feature and any of its sub-features.

Show Axes

Choose whether the coordinate axes of the selected feature should be visible on the 3D graphics. The choice applies on this screen and on the Move screen.

Changing the point

Use the **Change this point** button to set or change the selected feature. The **Move** tab (section 13.1) appears and a new feature position can be set.

Joggable

Choose whether the selected feature should be joggable. This determines whether the feature will appear in the feature menu on the Move screen.

Using Move robot here

Push the **Move robot here** button to move the Robot arm towards the selected feature. At the end of this movement, the coordinate systems of the feature and the TCP will coincide.

13.12.2 New Point

Push the **Point** button to add a point feature to the installation. The point feature defines a safety boundary or a global home configuration of the Robot arm. The point feature pose is defined as the position and orientation of the TCP.

Copyright © 2009–2019 by Universal Robots A/S. All rights reserved.

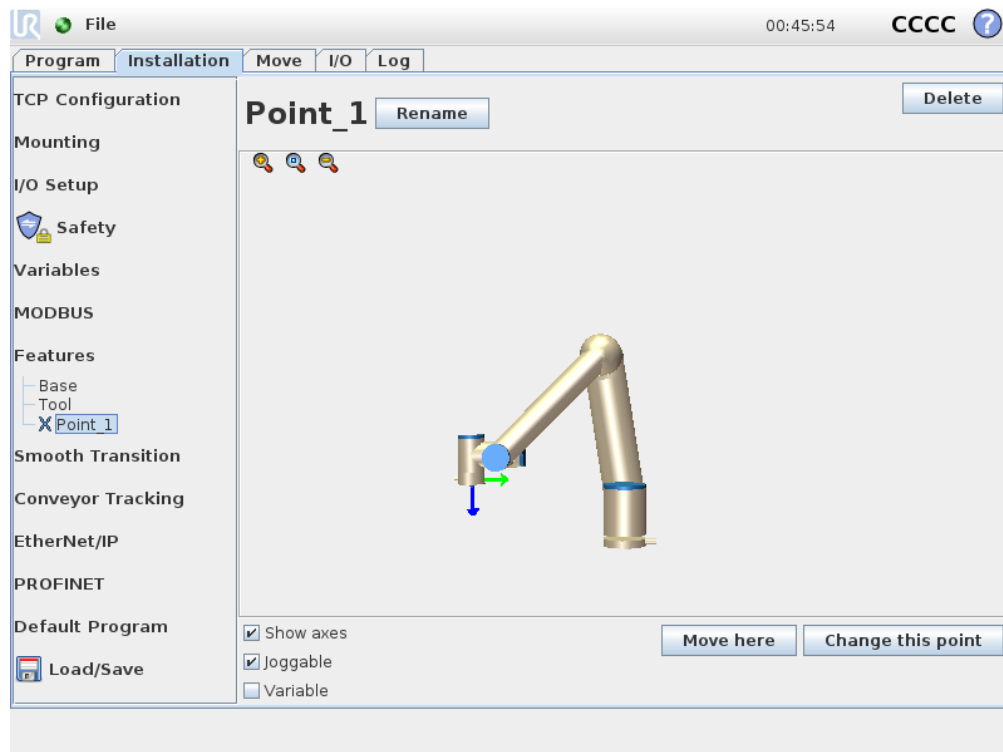

13.12.3 New Line

Push the **Line** button to add a line feature to the installation. The line feature defines lines that the robot needs to follow. (e.g., when using conveyor tracking). A line l is defined as an axis between two point features $p1$ and $p2$ as shown in figure 13.3.

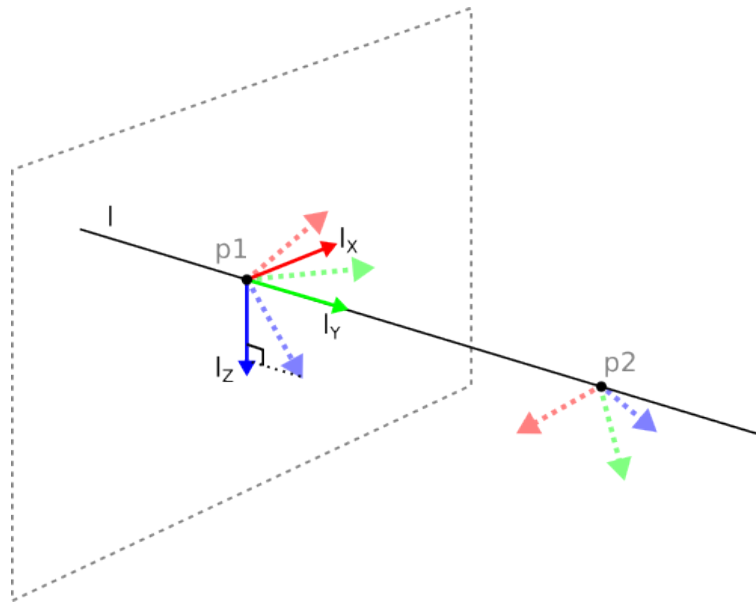
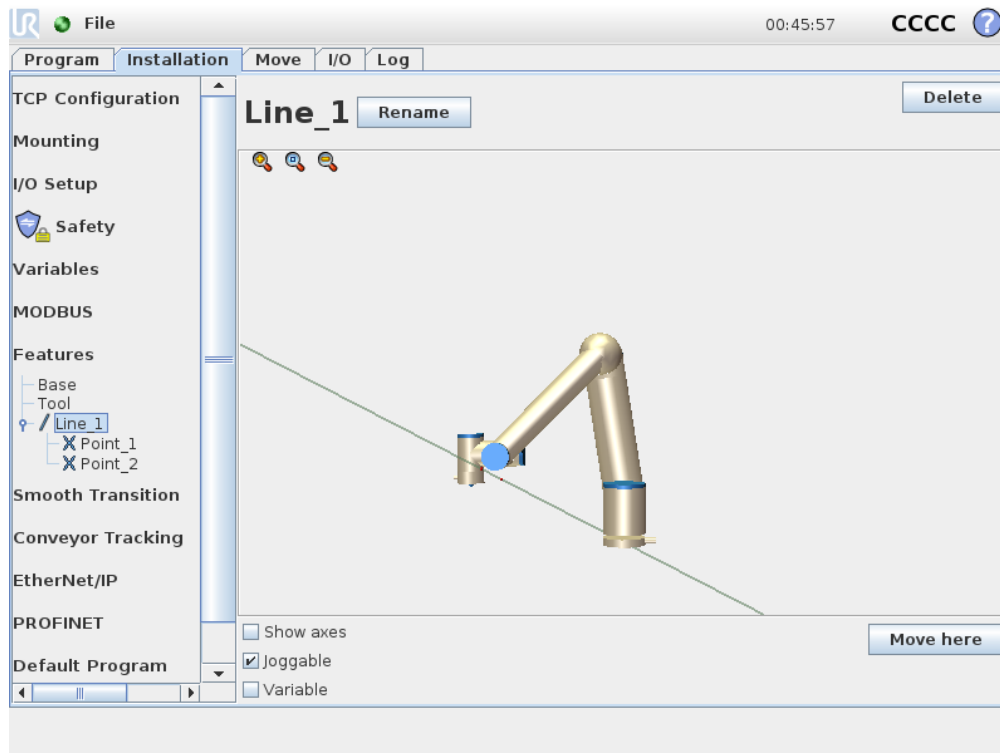

Figure 13.3: Definition of the line feature

In figure 13.3 the axis directed from the first point towards the second point, constitutes the y-axis of the line coordinate system. The z-axis is defined by the projection of the z-axis of $p1$ onto the plane perpendicular to the line. The position of the line coordinate system is the same as the position of $p1$.



Copyright © 2009–2019 by Universal Robots A/S. All rights reserved.

13.12.4 Plane Feature

Select the plane feature when you need a frame with high precision: e.g., when working with a vision system or doing movements relative to a table.

Adding a plane

1. In Installation, select **Features**.
2. Under Features select **Plane**.

Teaching a plane

When you press the plane button to create a new plane, the on-screen guide assists you creating a plane.

1. Select Origo
2. Move robot to define the direction of the positive x-axis of the plane
3. Move robot to define the direction of the positive y-axis of the plane

The plane is defined using the right hand rule so the z- axis is the cross product of the x-axis and the y-axis, as illustrated below.

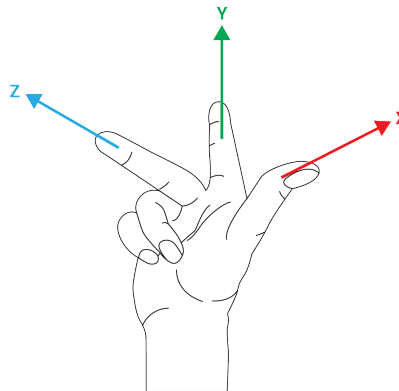

NOTE:

You can re-teach the plane in the opposite direction of the x-axis, if you want that plane to be normal in the opposite direction.

Modify an existing plane by selecting Plane and pressing Modify Plane. You will then use the same guide as for teaching a new plane.

13.12.5 Example: Manually Updating a Feature to Adjust a Program

Consider an application where multiple parts of a robot program is relative to a table. Figure 13.4 illustrates the movement from waypoints wp1 through wp4.

```

Robot Program
  MoveJ
    S1
  MoveL # Feature: P1_var
    wp1
    wp2
    wp3
    wp4

```

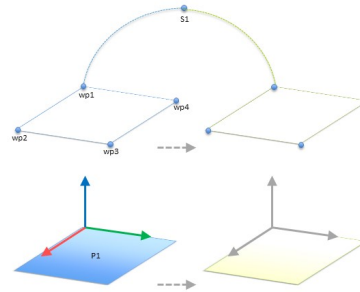

Figure 13.4: Simple program with four waypoints relative to a feature plane manually updated by changing the feature

The application requires the program to be reused for multiple robot installations where the position of the table varies slightly. The movement relative to the table is identical. By defining the table position as a feature $P1$ in the installation, the program with a *MoveL* command configured relative to the plane can be easily applied on additional robots by just updating the installation with the actual position of the table.

The concept applies to a number of Features in an application to achieve a flexible program can solve the same task on many robots even though if other places in the work space varies between installations.

13.12.6 Example: Dynamically Updating a Feature Pose

Consider a similar application where the robot must move in a specific pattern on top of a table to solve a particular task (see 13.5).

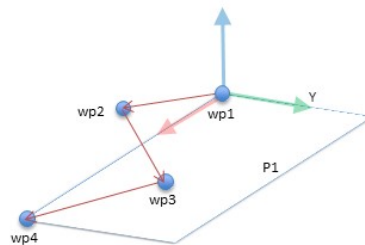

Figure 13.5: A *MoveL* command with four waypoints relative to a plane feature

The movement relative to $P1$ is repeated a number of times, each time by an offset o . In this example the offset is set to 10 cm in the Y-direction (see figure 13.6, offsets $O1$ and $O2$). This is achieved using *pose_add()* or *pose_trans()* script functions to manipulate the variable. It is possible to switch to a different feature while the program is running instead of adding an offset. This is shown in the example below (see figure 13.7) where the reference feature for the *MoveL* command $P1_var$ can switch between two planes $P1$ and $P2$.

```

Robot Program
MoveJ
  wp1
  y = 0.01
  o = p[0,y,0,0,0,0]
  P1_var = pose_trans(P1_var, o)
MoveL # Feature: P1_var
  wp1
  wp2
  wp3
  wp4

```

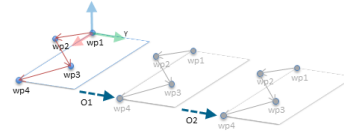

Figure 13.6: Applying an offset to the plane feature

```

Robot Program
MoveJ
  S1
if (digital_input[0]) then
  P1_var = P1
else
  P1_var = P2
MoveL # Feature: P1_var
  wp1
  wp2
  wp3
  wp4

```

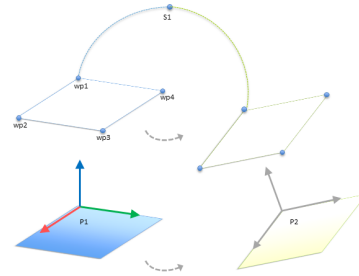

Figure 13.7: Switching from one plane feature to another

13.13 Conveyor Tracking Setup

The Conveyor Tracking Setup allows the movement of up to two separate conveyors to be configured. The Conveyor Tracking Setup provides options for configuring the robot to work with absolute or incremental encoders, as well as linear or circular conveyors.

Conveyor Parameters

Incremental: encoders can be connected to Digital Inputs 0 to 3. Decoding of digital signals runs at 40kHz. Using a **Quadrature** encoder (requiring two inputs), the robot can determine the speed and direction of the conveyor. If the direction of the conveyor is constant, a single input can be used to detect *Rising*, *Falling*, or *Rise and Fall* edges which determine conveyor speed.

Absolute: encoders can be connected through a MODBUS signal. This requires a Digital MODBUS Output register preconfigured in (section 13.11).

Tracking Parameters

Linear Conveyors: When a linear conveyor is selected, a line feature must be configured in the **Features** part of the installation to determine the direction of the conveyor. Ensure accuracy by placing the line feature parallel to the direction of the conveyor, with a large distance between the two points that define the line feature. Configure the line feature by placing the tool firmly

13.14 Smooth Transition Between Safety Modes

against the side of the conveyor when teaching the two points. If the line feature's direction is opposite to the conveyor's movement, use the **Reverse direction** button.

The **Ticks per meter** field displays the number of ticks the encoder generates when the conveyor moves one meter.

Circular Conveyors: When tracking a circular conveyor, the conveyor center point must be defined.

1. Define the center point in the **Features** part of the installation. The value of **Ticks per revolution** must be the number of ticks the encoder generates when the conveyor rotates one full revolution.
2. Select the **Rotate tool with conveyor** checkbox for the tool orientation to track the conveyor rotation.

13.14 Smooth Transition Between Safety Modes

When switching between safety modes during events (i.e., Reduced Mode Input, Reduced Mode Trigger Planes, Safeguard Stop, and Three-Position Enabling Device), the Robot Arm aims to use 0.4s to create a "soft" transition. Existing applications have unchanged behavior which corresponds to the "hard" setting. New installation files default to the "soft" setting.

13.14.1 Adjusting Acceleration/Deceleration Settings

- Press the Installation tab.
- In the Side Menu on the left, select Smooth Transition.
- Select Hard to have a higher acceleration/deceleration or select Soft for the smoother default transition setting.

13.15 Installation → Default Program

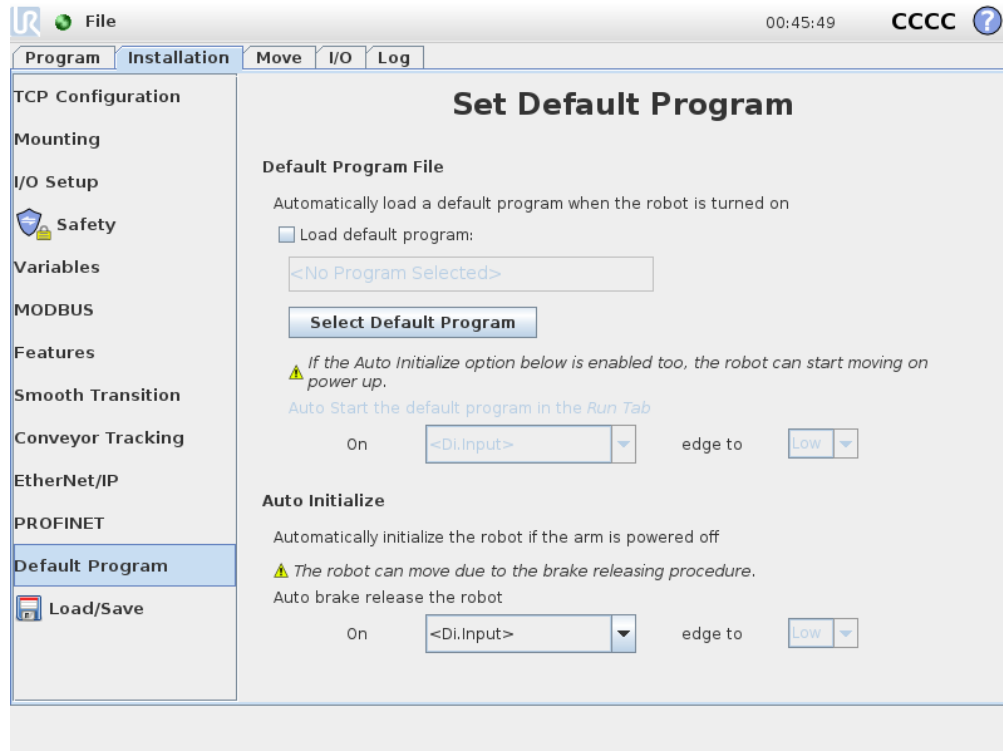

The Startup screen contains settings for automatically loading and starting a default program, and for auto-initializing the Robot arm during power up.



WARNING:

1. When autoload, auto start and auto initialize are enabled, the robot runs the program as soon as the Control Box is powered up as long as the input signal matches the selected signal level. For example, the edge transition to the selected signal level will not be required in this case.
2. Use caution when the signal level is set to LOW. Input signals are low by default, leading the program to automatically run without being triggered by an external signal.

Loading a Default Program

A default program is loaded after the Control Box is powered up. Furthermore, the default program is auto loaded when the **Run Program** screen (see 11.4) is entered and no program is loaded.

Starting a Default Program

The default program is auto started in the **Run Program** screen. When the default program is loaded and the specified external input signal edge transition is detected, the program is started automatically.

On Startup, the current input signal level is undefined. Choosing a transition that matches the signal level on startup starts the program immediately. Furthermore, leaving the **Run Program** screen or tapping the Stop button in the Dashboard disables the auto start feature until the Run button is pressed again.

Auto Initialization

The Robot arm is automatically initialized. On the specified external input signal edge transition, the Robot arm is completely initialized, regardless of the visible screen.

Brake Release is the final initialization stage. During Brake Release, the Robot arm makes a minor movement and a clicking noise. Furthermore, the brakes cannot be automatically released if the configured mounting does not match the mounting detected (based on sensor data). In this case, the robot must be initialized manually on the initialization screen (see 11.5).

On Startup, the current input signal level is undefined. Choosing a transition that matches the signal level on startup initializes the Robot arm immediately.

The auto initialization feature works when only the Robot arm is powered off.

13.16 Log Tab

The screenshot shows the 'Log' tab in the Universal Robots interface. It features a 'Readings' section on the left and a 'Joint Load' section on the right. Below these is a log of events with a 'Clear' button and navigation controls at the bottom.

Readings		Joint Load		Voltage	
Controller Temp.	30.0 °C	Base	OK	0.0A	0.0 V
Main Voltage	48.0 V	Shoulder	OK	1.5A	0.0 V
Avg.Robot Power	13 W	Elbow	OK	1.0A	0.0 V
Robot Current	5.2 A	Wrist 1	OK	0.2A	0.0 V
IO Current	0 A	Wrist 2	OK	0.0A	0.0 V
Tool Current	0 mA	Wrist 3	OK	0.0A	0.0 V

Log entries:

- 2019-08-26 00:44:26.698 RobotInterface C102A0: Real Robot not connected - Simulating Robot
- 2019-08-26 00:44:36.780 RobotInterface C102A0: Real Robot not connected - Simulating Robot
- 2019-08-26 00:45:02.475 RobotInterface C102A0: Real Robot not connected - Simulating Robot

Copyright © 2009–2019 by Universal Robots A/S. All rights reserved.

Robot Health The top half of the screen displays the “health” of the Robot Arm and Control Box. The left side of the screen shows information related to the Control Box, while the right side of the screen displays robot joint information. Each joint displays the temperature of the motor and electronics, the load of the joint, and the voltage.

Robot Log Messages are displayed on the bottom half of the screen. The first column categorizes the severity of the log entry. The second column shows the messages’ time of arrival. The next column shows the sender of the message. The last column shows the message itself. Messages can be filtered by selecting the toggle buttons which correspond to the severity of the log entry. The figure above shows errors will be displayed while information and warning messages will be filtered. Some log messages are designed to provide more information that is accessible by selecting the log entry.

13.16.1 Saving Error Reports

When an error occurs in PolyScope, a log of the error is generated. In the Log Tab, you can track and/or export generated reports to a USB drive (see 13.16). The following list of errors can be tracked and exported:

- Fault
- Internal PolyScope exceptions
- Protective Stop
- Unhandled exception in URCap
- Violation

The exported report contains: a user program, a history log, an installation and a list of running services.

Error Report A detailed status report is available when a paper clip icon appears on the log line.

- Select a log line and tap the Save Report button to save the report to a USB drive.
- The report can be saved while a program is running.



NOTE:

The oldest report is deleted when a new one is generated. Only the five most recent reports are stored.

13.17 Load Screen

On this screen you choose which program to load. There are two versions of this screen: one that is to be used when you just want to load a program and execute it, and one that is used when you want to actually edit a program.

**NOTE:**

Running a program from a USB drive is not recommended. To run a program stored on a USB drive, first load it and then save it in the local `programs` folder using the **Save As...** option in the **File** menu.

The main difference lies in which actions are available to the user. In the basic load screen, the user will only be able to access files - not modify or delete them. Furthermore, the user is not allowed to leave the directory structure that descends from the `programs` folder. The user can descend to a sub-directory, but he cannot get any higher than the `programs` folder.

Therefore, all programs should be placed in the `programs` folder and/or sub folders under the `programs` folder.

Screen layout

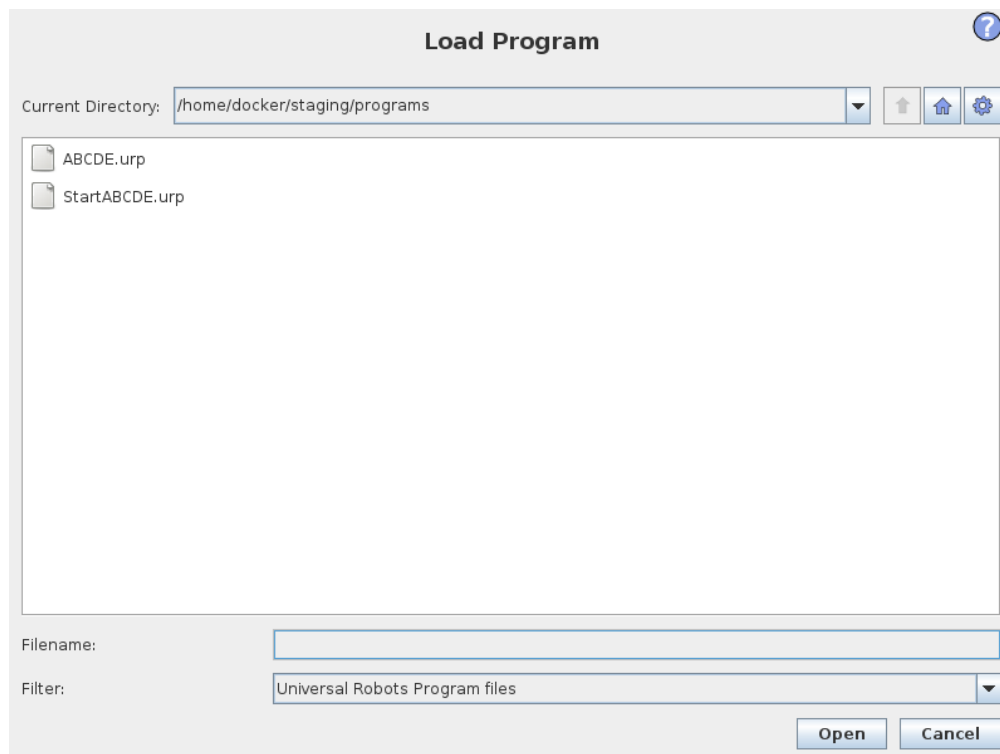

This image shows the actual load screen. It consists of the following important areas and buttons:

Path history The path history shows a list of the paths leading up to the present location. This means that all parent directories up to the root of the computer are shown. Here you will notice that you may not be able to access all the directories above the programs folder.

By selecting a folder name in the list, the load dialog changes to that directory and displays it in the file selection area (see 13.17).

File selection area In this area of the dialog the contents of the actual area is present. It gives the user the option to select a file by single clicking on its name or to open the file by double clicking on its name.

Directories are selected by a long press of approximately 0.5 s. Descending into a folder and presenting its content is done by single clicking it.

File filter By using the file filter, one can limit the files shown to include the type of files that one wishes. By selecting **Backup Files** the file selection area will display the latest 10 saved versions of each program, where `.old0` is the newest and `.old9` is the oldest.

File field Here the currently selected file is shown. The user has the option to manually enter the file name of a file by clicking on the keyboard icon to the right of the field. This will cause an on-screen keyboard to pop up where the user can enter the file name directly on the screen.

Open button Clicking on the Open button, will open the currently selected file and return to the previous screen.

Cancel button Clicking on the Cancel button will abort the current loading process and cause the screen to switch to the previous image.

Action buttons A series of buttons gives the user the ability to perform some of the actions that normally would be accessible by right-clicking on a file name in a conventional file dialog. Added to this is the ability to move up in the directory structure and directly to the program folder.

- Parent: Move up in the directory structure. The button will not be enabled in two cases: when the current directory is the top directory or if the screen is in the limited mode and the current directory is the program folder.
- Go to program folder: Go home
- Actions: Actions such as create directory, delete file etc.

13.18 Run Tab

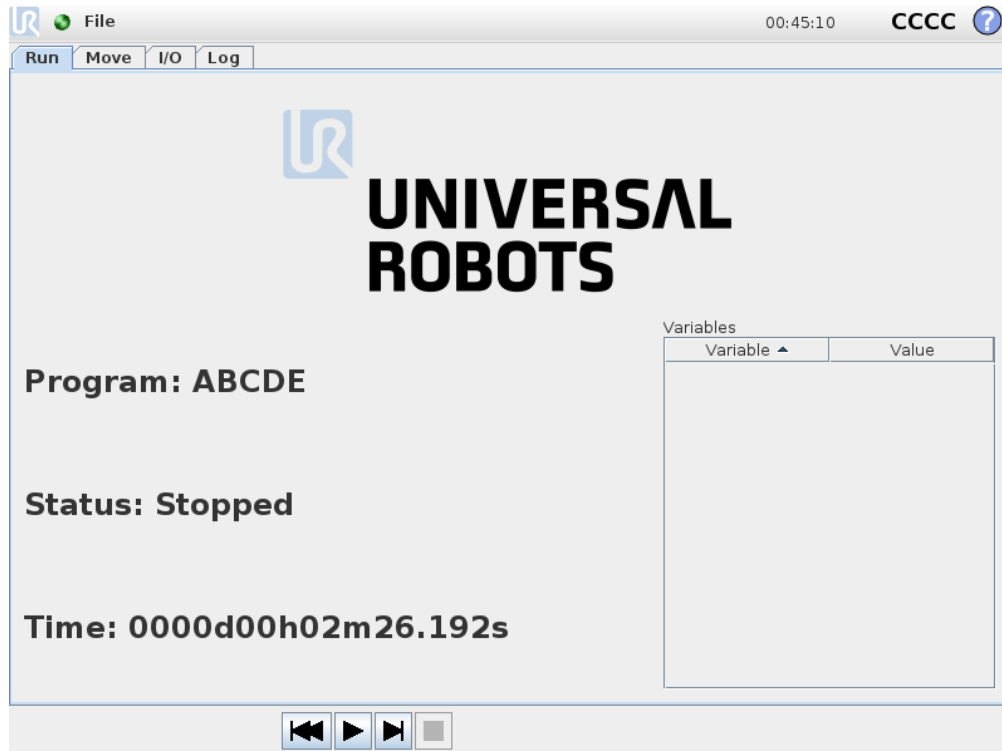

This tab provides a very simple way of operating the robot arm and control box, with as few buttons and options as possible. This can be usefully combined with password protecting the programming part of PolyScope (see 15.3), to make the robot into a tool that can run exclusively pre-written programs.

Furthermore, in this tab a default program can be automatically loaded and started based on an external input signal edge transition (see 13.15). The combination of auto loading and starting of a default program and auto initialization on power up can, for instance, be used to integrate the robot arm into other machinery.

Copyright © 2009–2019 by Universal Robots A/S. All rights reserved.

14 Programming

14.1 New Program

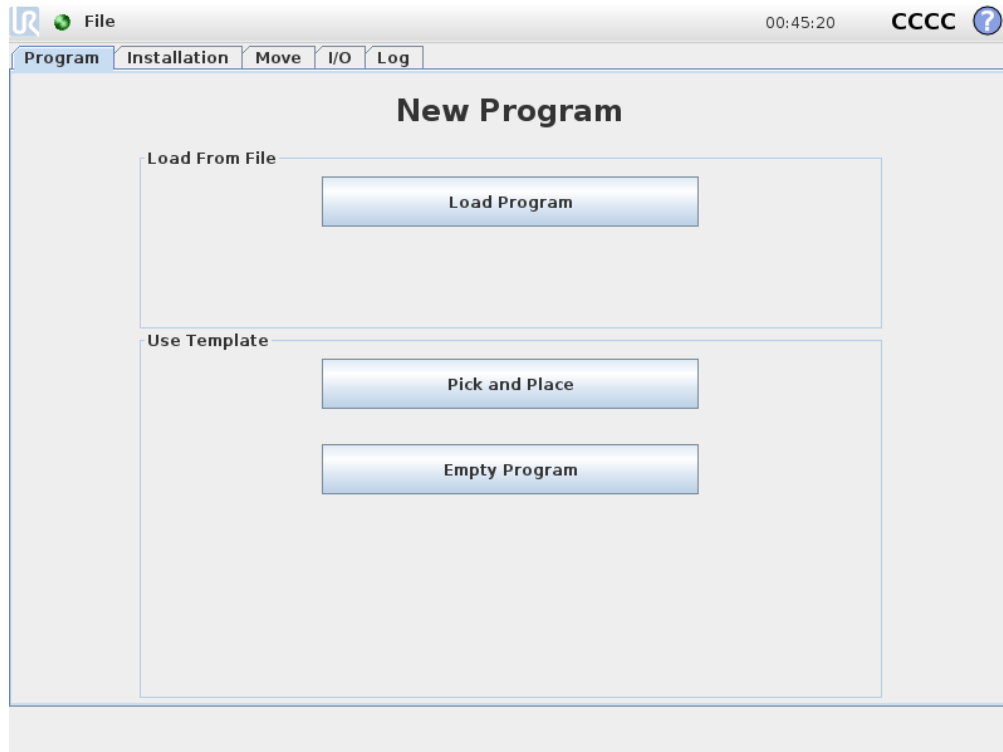

A new robot program can start from either a *template* or from an existing (saved) robot program. A *template* can provide the overall program structure, so only the details of the program need to be filled in.

14.2 Program Tab

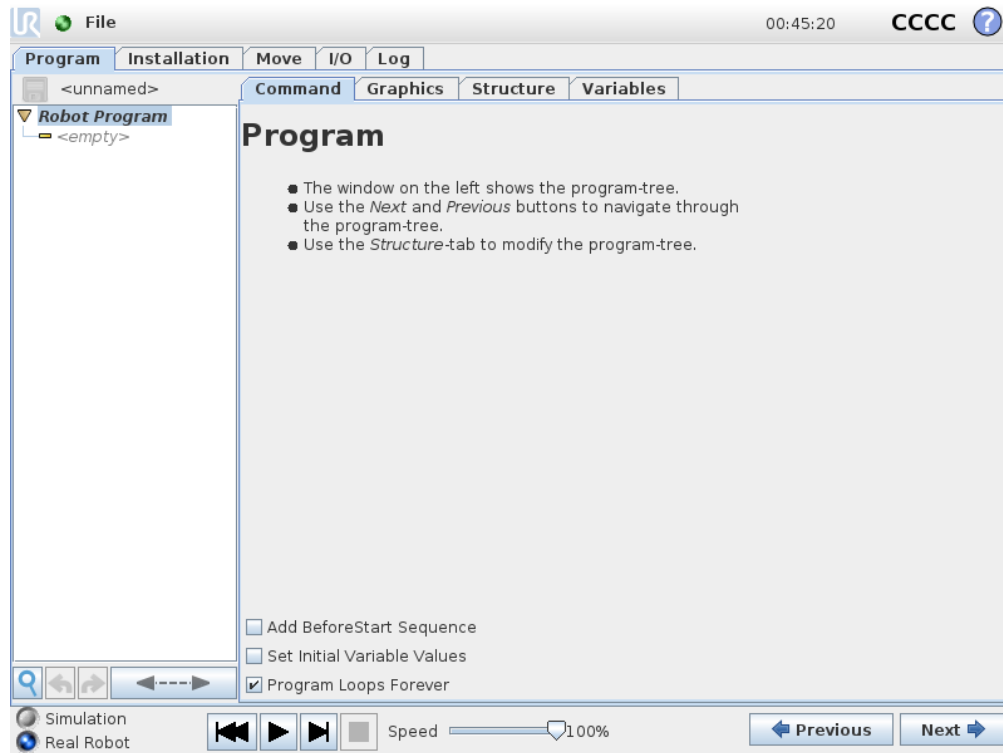

The program tab shows the current program being edited.

14.2.1 Program Tree





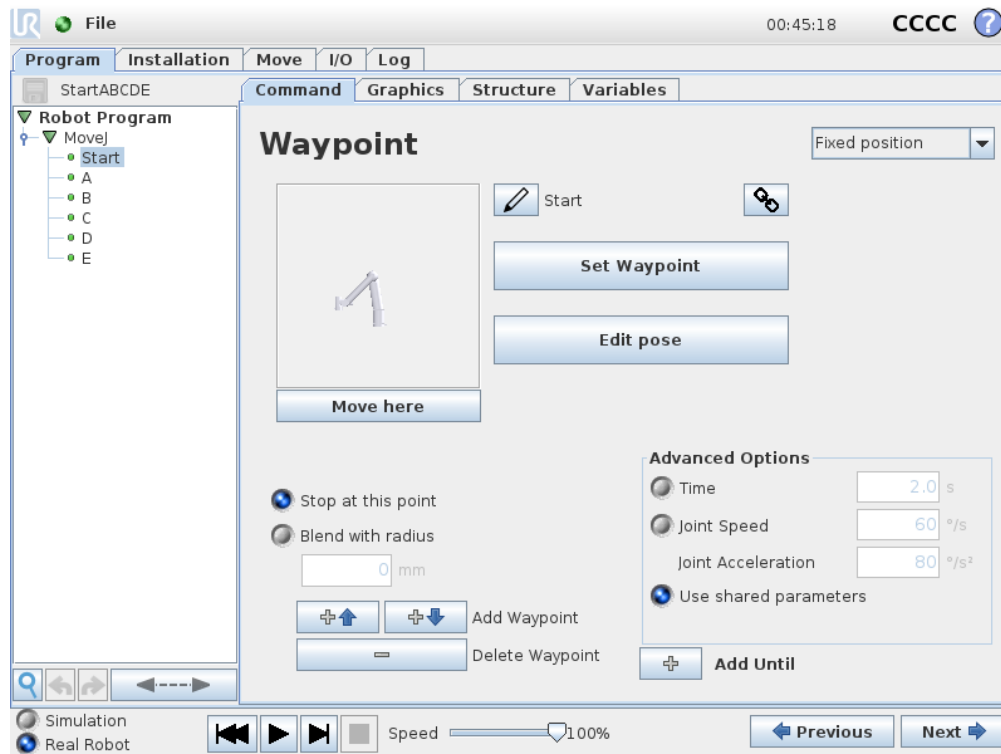

The **Program Tree** on the left side of the screen displays the program as a list of commands, while the area on the right side of the screen displays information relating to the current command.

The current command is selected by clicking the command list, or by using the **Previous** and **Next** buttons on the bottom right of the screen. Commands can be inserted or removed using the **Structure** tab. The program name is shown directly above the command list, with a small disk icon that can be clicked to quickly save the program.



In the Program Tree, the command that is currently being executed is highlighted as described in 14.2.2.

14.2.2 Program Execution Indication





The **Program Tree** contains visual cues informing about the command currently being executed by the robot controller. A small  indicator icon is displayed to the left of the command icon, and the name of the executing command and any commands of which this command is a sub-command (typically identified by the  /  command icons) are highlighted with blue. This aids the user in locating the executing command in the tree. For example, if the robot arm is moving towards a waypoint, the corresponding waypoint sub-command is marked with the  icon and its name together with the name of the Move command (see 14.4) to which it belongs to are shown in blue. If the program is paused, the program execution indicator icon marks the last command that was in the process of being executed. Clicking the button with the  icon below the Program Tree jumps to the current executing or the last executed command in the tree. If a command is clicked while a program is running, the Command tab will keep displaying the information related to the selected command. Pressing the  button will make the Command tab continuously show information about the currently executing commands again.

14.2.3 Search Button

Tap the  to search in the Program Tree. When clicked a search text can be entered and program nodes that match will be highlighted in yellow. Additionally, navigation buttons are made available to navigate through the matches. Press the  icon to exit search. Note: The Program Tree must be expanded to access the additional navigation buttons.

14.2.4 Undo/Redo Buttons

The buttons with icons  and  in the toolbar at the base of the Program Tree serve to undo and redo changes made in the Program Tree and in the commands it contains.

14.2.5 Program Dashboard

The lowest part of the screen is the *Dashboard*. The *Dashboard* features a set of buttons similar to an old-fashioned tape recorder, from which programs can be started and stopped, single-stepped and restarted. The *speed slider* allows you to adjust the program speed at any time, which directly affects the speed at which the robot arm moves. Additionally, the *speed slider* shows in real time the relative speed at which the robot arm moves taking into account the safety settings. The indicated percentage is the maximum achievable speed for the running program without violating the safety limits.

To the left of the *Dashboard* the *Simulation* and *Real Robot* buttons toggle between running the program in a simulation, or running it on the real robot. When running in simulation, the robot arm does not move and thus cannot damage itself or any nearby equipment in collisions. Use simulation to test programs if unsure about what the robot arm will do.



DANGER:

1. Make sure to stay outside the robot workspace when the `Play` button is pressed. The movement you programmed may be different than expected.
2. Only use the `Step` button when it is absolutely necessary. Make sure to stay outside the robot workspace when the `Step` button is pressed.
3. Make sure to always test your program by reducing the speed with the speed slider. Logic programming errors made by the integrator might cause unexpected movements of the robot arm.
4. When an emergency stop or protective stop has occurred, the robot program will stop. It can be resumed as long as no joint has moved more than 10°. When pressing play, the robot will move slowly back onto the trajectory, and continue program execution.

While the program is being written, the resulting motion of the robot arm is illustrated using a 3D drawing on the *Graphics* tab, described in 14.30.

Next to each program command is a small icon, which is either red, yellow or green. A red icon means that there is an error in that command, yellow means that the command is not finished, and green means that all is OK. A program can only be run when all commands are green.

14.3 Variables

A robot program can make use of variables to store and update various values during runtime. Two kinds of variables are available:

Installation variables: These can be used by multiple programs and their names and values are persisted together with the robot installation (see 13.10). Installation variables keep their value after the robot and control box has been rebooted.

Regular program variables: These are available to the running program only and their values are lost as soon as the program is stopped.

Variable types:

<i>bool</i>	A boolean variable whose value is either <code>True</code> or <code>False</code> .
<i>int</i>	A whole number in the range from -2147483648 to 2147483647 (32 bit).
<i>float</i>	A floating point number (decimal) (32 bit).
<i>string</i>	A sequence of characters.
<i>pose</i>	A vector describing the location and orientation in Cartesian space. It is a combination of a position vector (x, y, z) and a rotation vector (rx, ry, rz) representing the orientation, written $p[x, y, z, rx, ry, rz]$.
<i>list</i>	A sequence of variables.

14.4 Command: Move

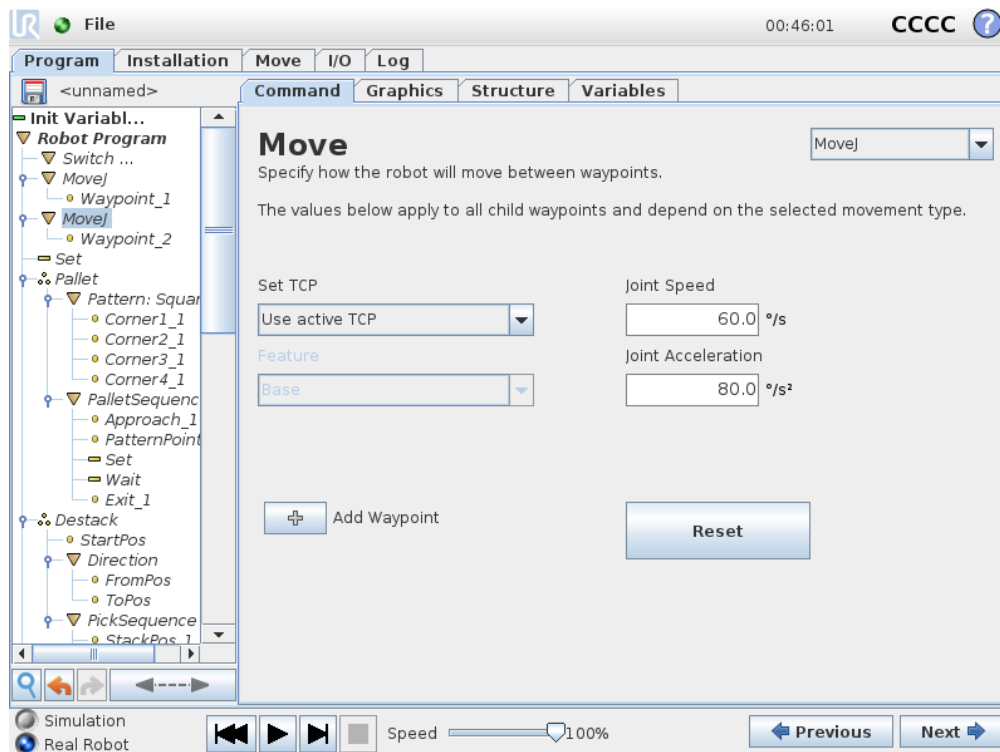

The **Move** command controls the robot motion through the underlying waypoints. Waypoints have to be under a Move command. The Move command defines the acceleration and the speed at which the robot arm will move between those waypoints.

Movement Types

You can select one of three types of movements: **MoveJ**, **MoveL** and **MoveP**. Each movement type is explained below.

- **moveJ** makes movements that are calculated in the robot arm **joint space**. Each joint is controlled to reach the desired end location at the same time. This movement type results in a curved path for the tool. The shared parameters that apply to this movement type are the maximum joint speed and joint acceleration, specified in *deg/s* and *deg/s²*, respectively. If it is desired to have the robot arm move fast between waypoints, disregarding the path of the tool between those waypoints, this movement type is the preferable choice.
- **moveL** moves the Tool Center Point (TCP) linearly between waypoints. This means that each joint performs a more complicated motion to keep the tool on a straight line path. The shared parameters that can be set for this movement type are the desired tool speed and tool acceleration specified in *mm/s* and *mm/s²*, respectively, and also a feature.
- **moveP** moves the tool linearly with constant speed with circular blends, and is intended for some process operations, like gluing or dispensing. The size of the blend radius is by default a shared value between all the waypoints. A smaller value will make the path turn sharper whereas a higher value will make the path smoother. While the robot arm is moving through the waypoints with constant speed, the robot control box cannot wait for either an I/O operation or an operator action. Doing so might stop the robot arm's motion, or cause a protective stop.
- **Circle move** can be added to a **moveP** to make a circular movement. The robot starts the movement from its current position or start point, moves through a **ViaPoint** specified on the circular arc, and an **EndPoint** that completes the circular movement. A mode is used to calculate tool orientation, through the circular arc. The mode can be:
 - Fixed: only the start point is used to define tool orientation
 - Unconstrained: the start point transforms to the **EndPoint** to define tool orientation

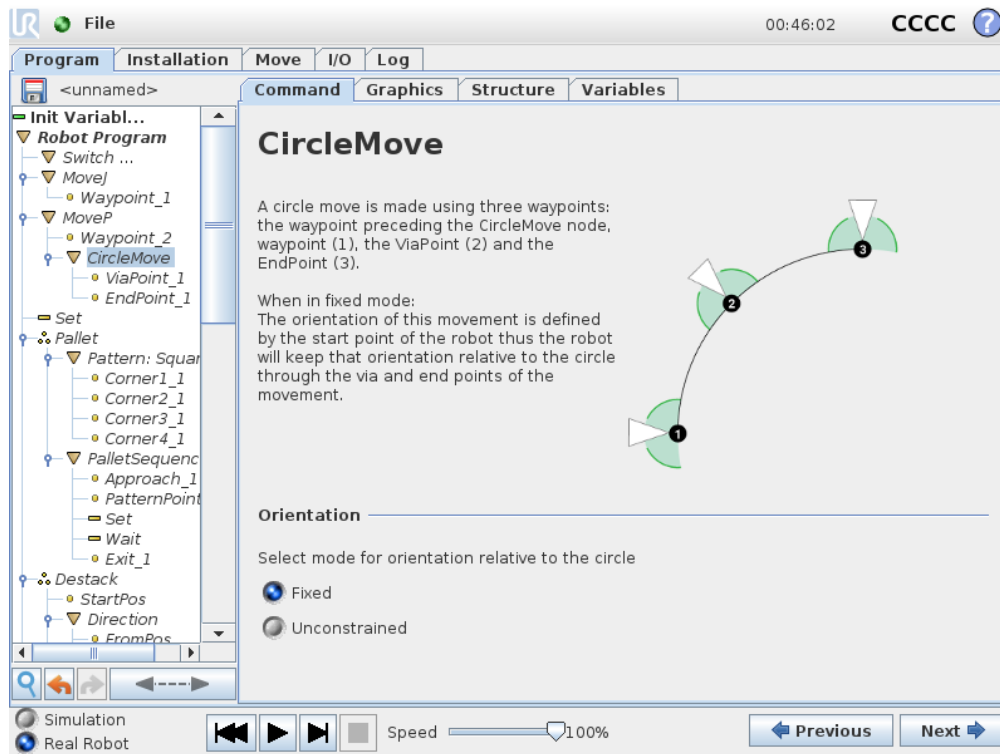

Shared parameters

The shared parameters in the bottom right corner of the Move screen apply to the movement from the previous position of the robot arm to the first waypoint under the command, and from there to each of the following waypoints. The Move command settings do not apply to the path going *from* the last waypoint under that Move command.

TCP selection

The TCP used for the waypoints under this Move command can be selected from the drop-down menu. It is possible to select from user defined TCPs from the installation, the active TCP or simply using the tool flange. If a user defined TCP or the active TCP is selected, the motion under this Move command will adjusted be with respect to this. If **Use Tool Flange** is selected, no TCP is used and the motion under this Move command will be with respect to the tool flange (i.e. no adjustments to the motion).

If the active TCP for this motion is determined during runtime of the program, it needs to be set dynamically using the Set command (see 14.11) or by using script commands. For further information about configuring named TCPs (see 13.6).

Feature selection

The feature spaces the waypoints under the Move command, that should be represented when specifying these waypoints (see section 13.12). This means that when setting a waypoint, the program will remember the tool coordinates in the feature space of the selected feature. There are a few circumstances that need detailed explanation:

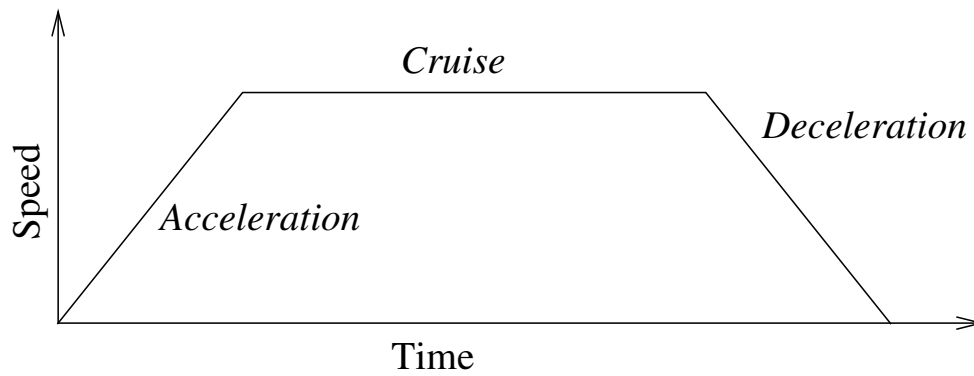

Figure 14.1: Speed profile for a motion. The curve is divided into three segments: *acceleration*, *cruise* and *deceleration*. The level of the *cruise* phase is given by the speed setting of the motion, while the steepness of the *acceleration* and *deceleration* phases is given by the acceleration parameter.

Relative waypoints: The selected feature has no effect on relative waypoints. The relative movement is always performed with respect to orientation of the **Base**.

Variable waypoints: When the robot arm moves to a variable waypoint, the Tool Center Point (TCP) is calculated as the coordinates of the variable in the space of the selected feature. Therefore, the robot arm movement for a variable waypoint changes if another feature is selected.

Variable feature: If any of the features in the currently loaded installation are selected as variable, these corresponding variables are also selectable in the feature selection menu. If a feature variable (named with the name of the feature suffixed by “_var”) is selected, robot arm movements (except to **Relative waypoints**) are relative to the actual value of the variable when the program is running. The initial value of a feature variable is the value of the actual feature as configured in the installation. If this value is modified, then the movements of the robot change.

14.5 Command: Fixed Waypoint

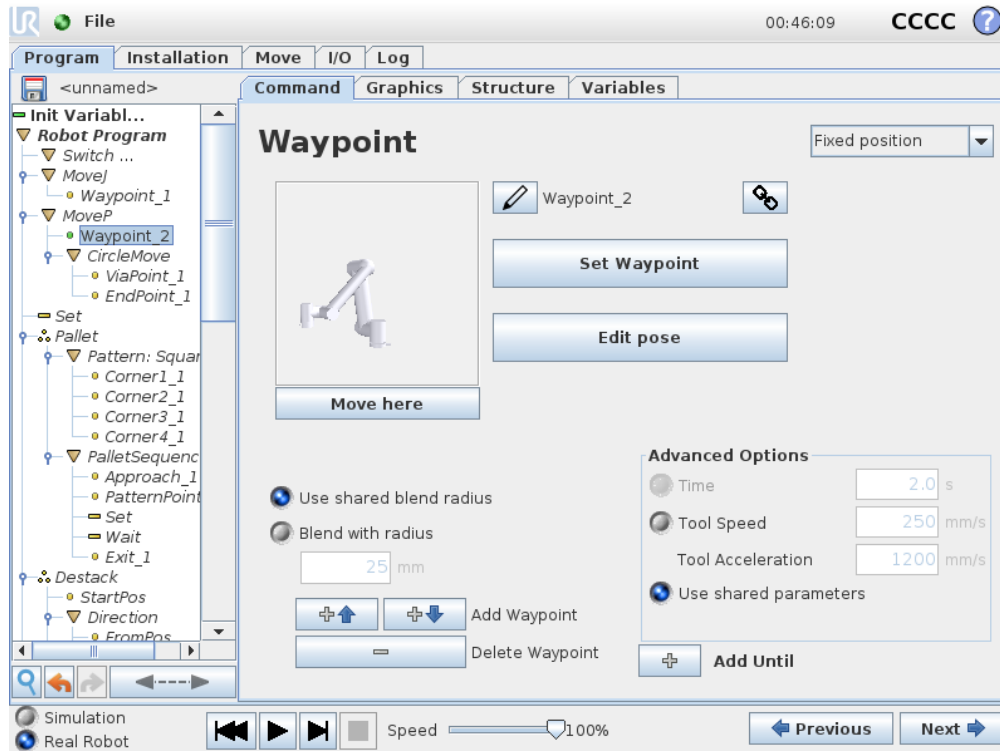

A point on the robot path. Waypoints are the most central part of a robot program, telling the robot arm where to be. A fixed position waypoint is taught by physically moving the robot arm to the position.

Setting the waypoint

Press this button to enter the Move screen where you can specify the robot arm's position for this waypoint. If the waypoint is placed under a Move command in linear space (**moveL** or **moveP**), there needs to be a valid feature selected at that Move command, in order for this button to be pressable.

Waypoint names

Waypoints automatically get a unique name. The name can be changed by the user. By selecting the link icon, waypoints are linked and share position information. Other waypoint information such as blend radius, tool/joint speed and tool/joint acceleration is configured for individual waypoints even though they may be linked.

Blending

Blending enables the robot to smoothly transition between two trajectories, without stopping at the waypoint between them.

Example Consider a pick and place application as an example (see figure 14.2), where the robot is currently at Waypoint 1 (WP_1), and it needs to pick up an object at Waypoint 3 (WP_3). To avoid collisions with the object and other obstacles (O), the robot must approach WP_3 in the direction coming from Waypoint 2 (WP_2). So three waypoints are introduced to create a path that fulfils the requirements.

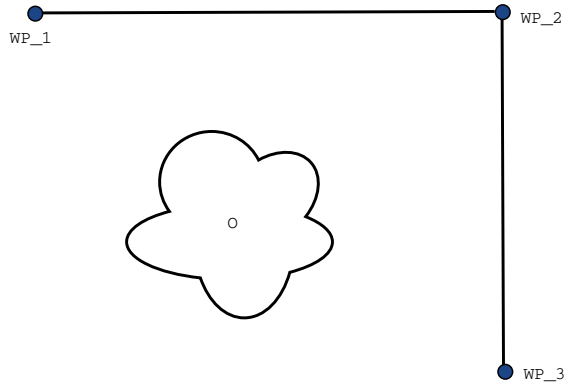

Figure 14.2: WP_1: initial position, WP_2: via point, WP_3: pick up position, O: obstacle.

Without configuring other settings, the robot will make a stop at each waypoint, before continuing the movement. For this task a stop at WP_2 is not optimal since a smooth turn would require less time and energy while still fulfilling the requirements. It is even acceptable that the robot does not reach WP_2 exactly, as long as the transition from the first trajectory to the second happens near this position.

The stop at WP_2 can be avoided by configuring a blend for the waypoint, allowing the robot to calculate a smooth transition into the next trajectory. The primary parameter for the blend is a radius. When the robot is within the blend radius of the waypoint it can start blending and deviate from the original path. This allows for faster and smoother movements, as the robot does not need to decelerate and re-accelerate.

Blend parameters Apart from the waypoints, multiple parameters will influence the blend trajectory (see figure 14.3):

- the blend radius (r)
- the initial and final speed of the robot (at positions p_1 and p_2 , respectively)
- the movement time (e.g. if setting a specific time for a trajectory this will influence the initial/final speed of the robot)
- the trajectory types to blend from and to (`MoveL`, `MoveJ`)

If a blend radius is set, the robot arm trajectory blends around the waypoint, allowing the robot arm not to stop at the point.

Blends cannot overlap, so it is not possible to set a blend radius that overlaps with the blend radius of a previous or following waypoint as shown in figure 14.4.

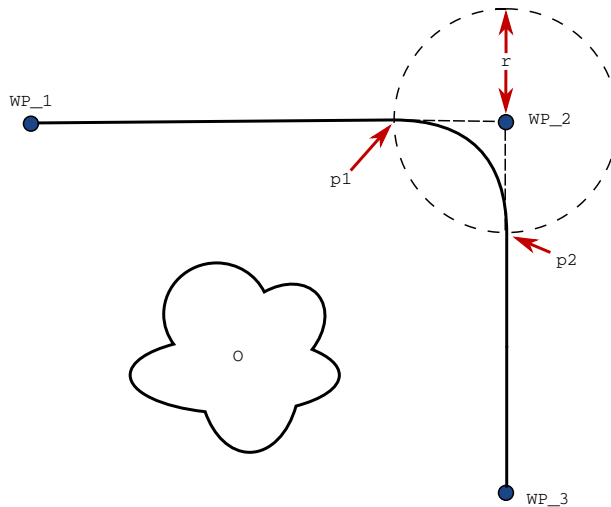

Figure 14.3: Blend over WP_2 with radius r , initial blend position at $p1$ and final blend position at $p2$. O is an obstacle.

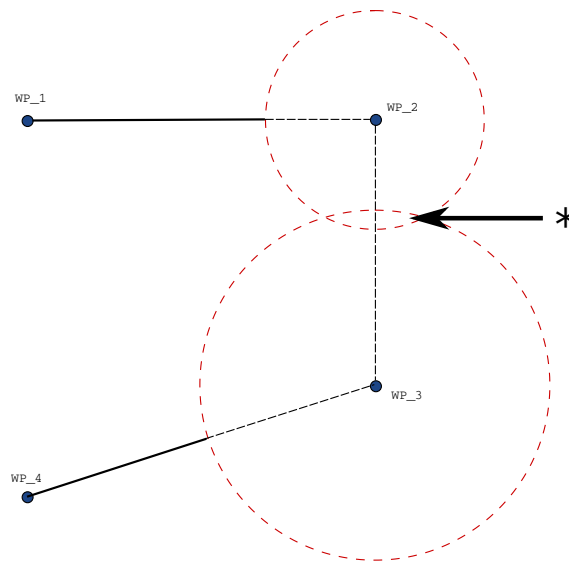

Figure 14.4: Blend radius overlap not allowed (*).

Conditional blend trajectories The blend trajectory is affected both by the waypoint where the blend radius is set and the following one in the program tree. That is, in the program in figure 14.5 the blend around WP_1 is affected by WP_2. The consequence of this becomes more apparent when blending around WP_2 in this example. There are two possible ending positions and to determine which is the next waypoint to blend to, the robot must evaluate the current reading of the `digital_input[1]` already when entering the blend radius. That means the **if...then** expression (or other necessary statements to determine the following waypoint, e.g. variable waypoints) is

evaluated before we actually reach WP_2 which is somewhat counter-intuitive when looking at the program sequence. If a waypoint is a stop point and followed by conditional expressions to determine the next waypoint (e.g. the I/O command) it is executed when the robot arm has stopped at the waypoint.

```

MoveL
  WP_I
  WP_1 (blend)
  WP_2 (blend)
  if (digital_input[1]) then
    WP_F_1
  else
    WP_F_2

```

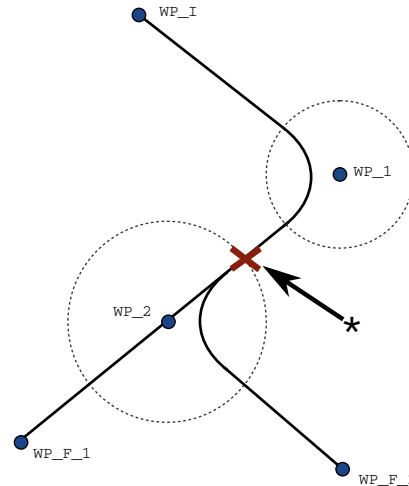

Figure 14.5: WP_I is the initial waypoint and there are two potential final waypoints WP_F_1 and WP_F_2, depending on a conditional expression. The conditional if expression is evaluated when the robot arm enters the second blend (*).

Trajectory type combinations It is possible to blend between all four combinations of trajectory types of **MoveJ** and **MoveL**, but the specific combination will affect the computed blend trajectory. There are 4 possible combinations:

1. **MoveJ** to **MoveJ** (Pure Joint space blend)
2. **MoveJ** to **MoveL**
3. **MoveL** to **MoveL** (Pure Cartesian space blend)
4. **MoveL** to **MoveJ**

Pure joint space blending (bullet 1) vs. pure Cartesian space blending (bullet 3) is compared in figure 14.6. It shows two potential paths of the tool for identical sets of waypoints.

Of the different combinations, bullets 2, 3 and 4 will result in trajectories that keep within the boundaries of the original trajectory in Cartesian space. An example of a blend between different trajectory types (bullet 2) can be seen in figure 14.7.

Pure joint space blends (bullet 1), however, may behave in a way that is less intuitive, since the robot will try to achieve the smoothest possible trajectory in Joint space taking velocities and time requirements into account. Due to this, they may deviate from the course specified by the waypoints. This is especially the case if there are significant differences in a joint's velocity between the

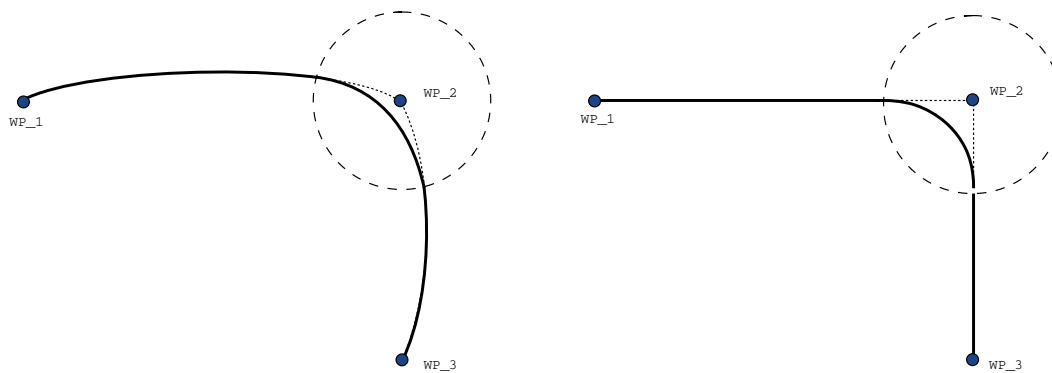

Figure 14.6: Joint space (MoveJ) vs. cartesian space (MoveL) movement and blend.

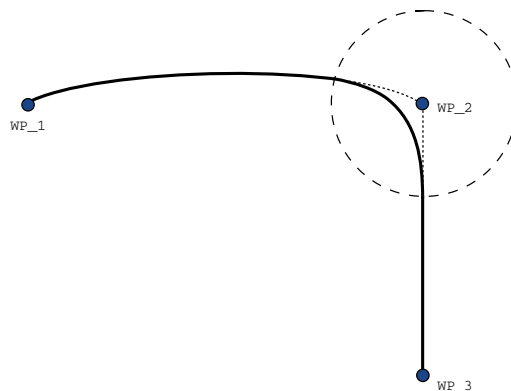

Figure 14.7: Blending from a movement in joint space (MoveJ) to linear tool movement (MoveL).

two trajectories. *Caution:* if the velocities are very different (e.g. by specifying advanced settings - either velocity or time - for a specific waypoint) this can result in large deviations from the original trajectory as shown in figure 14.8. If you need to blend between different velocities and cannot accept this deviation consider a blend in Cartesian space using **MoveL** instead.

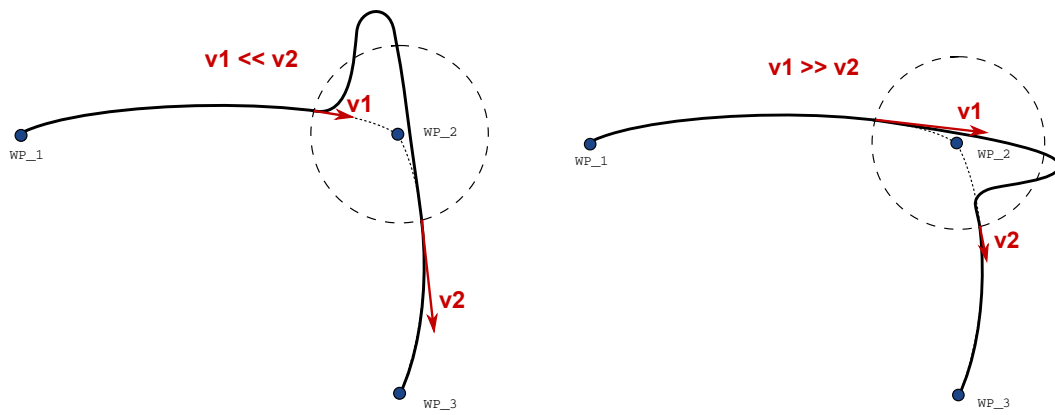
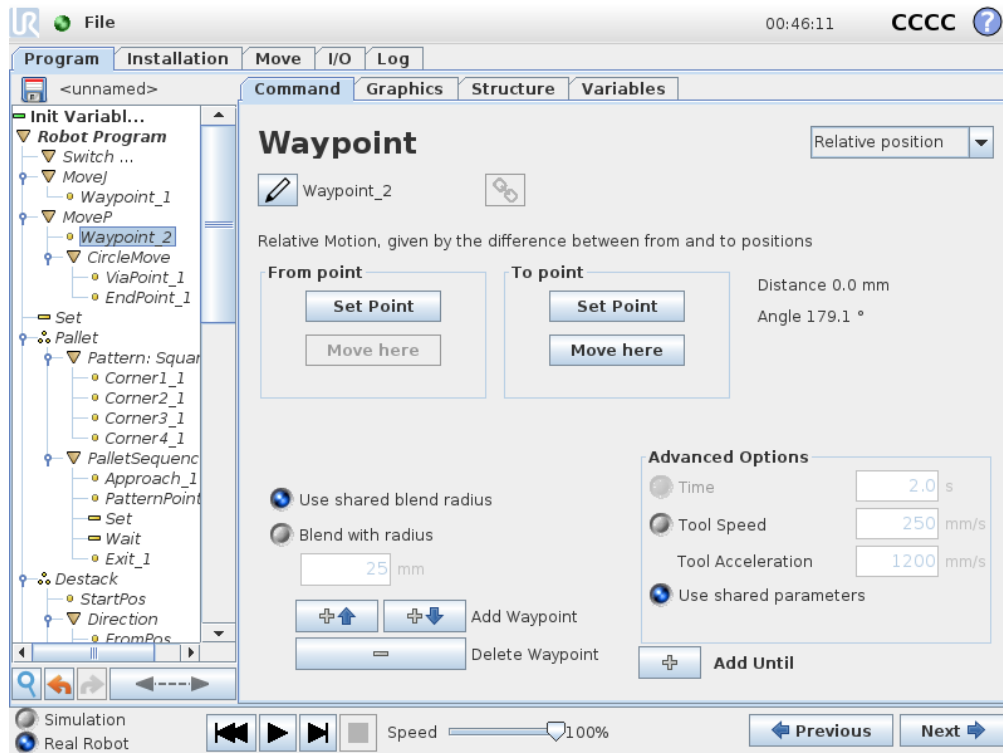

Figure 14.8: Joint space blending when initial velocity $v1$ is significantly smaller than final velocity $v2$ or the opposite.

14.6 Command: Relative Waypoint



A waypoint with the position given relative to the robot arm's previous position, such as "two centimeters to the left". The relative position is defined as the difference between the two given positions (left to right).

Note: repeated relative positions can move the robot arm out of its workspace.

The distance here is the Cartesian distance between the TCP in the two positions. The angle states how much the TCP orientation changes between the two positions. More precisely, the length of the rotation vector describing the change in orientation.

14.7 Command: Variable Waypoint

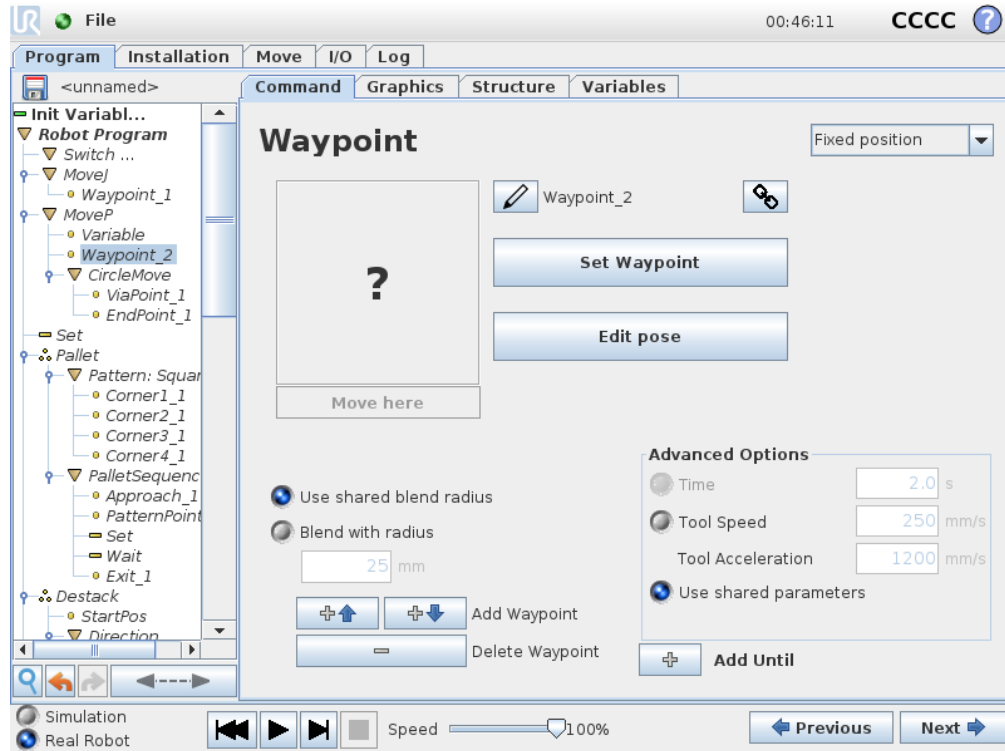

A waypoint with the position given by a variable, in this case `calculated_pos`. The variable has to be a *pose* such as

`var=p[0.5,0.0,0.0,3.14,0.0,0.0]`. The first three are *x,y,z* and the last three are the orientation given as a *rotation vector* given by the vector *rx,ry,rz*. The length of the axis is the angle to be rotated in radians, and the vector itself gives the axis about which to rotate. The position is always given in relation to a reference frame or coordinate system, defined by the selected feature. If a blend radius is set on a fixed waypoint and the waypoints preceding and succeeding it are variable or if the blend radius is set on a variable waypoint, then the blend radius will not be checked for overlap (see 14.5). If, when running the program, the blend radius overlaps a point, the robot will ignore it and move to the next one.

For example, to move the robot 20 mm along the z-axis of the tool:

```
var_1=p[0,0,0.02,0,0,0]
MoveL
  Waypoint_1 (variable position):
  Use variable=var_1, Feature=Tool
```

14.8 Command: Direction

The program node *Direction* specifies a motion relative to feature axes or TCPs. The robot moves in along the path specified by the Direction Program Node until that movement is stopped by an

Until condition. You must have *Until* conditions for stopping a direction movement, tap the *Add Until* button to define the stop criteria.

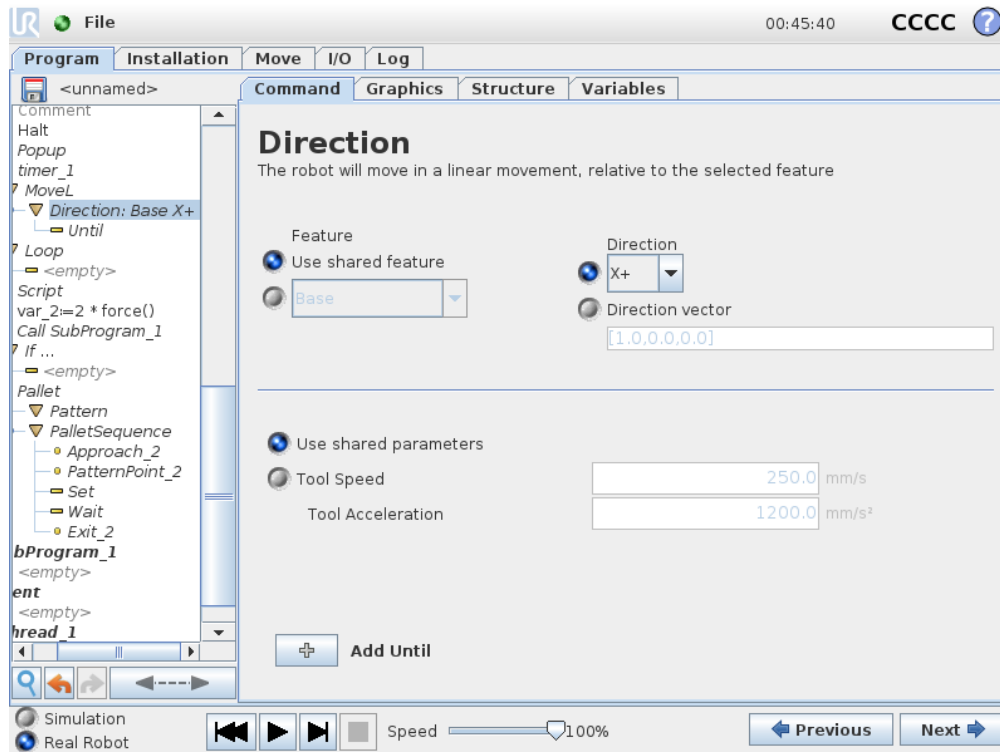

Stopping a Direction Movement

You can add Direction Vector settings, for **Tool Speed** and **Tool Acceleration**, to define the vector direction for linear motion, allowing for advanced uses as:

- defining linear motion relative to multiple feature axes
- computing the direction as a mathematical expression

The Direction Vectors defines a custom code expression that is resolved to a unit vector. For example, for a vector of [2,1,0] the robot moves two units in the x direction for every unit in the y direction, relative to the specified speed.

14.9 Command: Until

The program node **Until** defines a stop criterion for a motion. The robot moves along a path and stops when contact is detected.

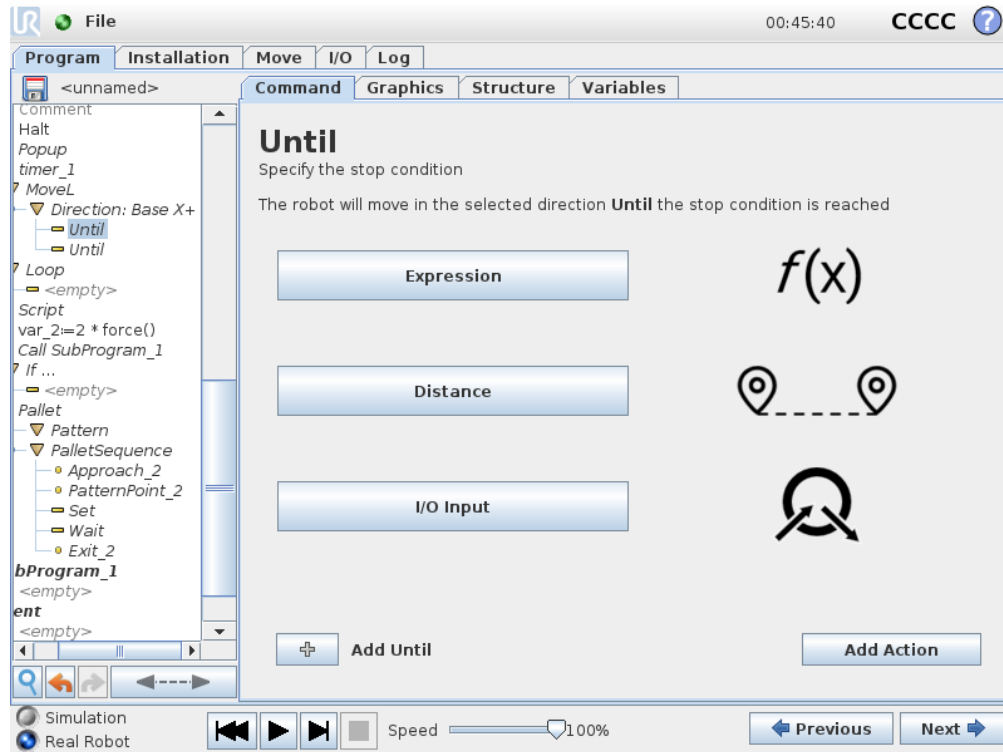

In the **Until** field, you can define the following stop criteria:

- **Add Action** Add program nodes if a specific until condition is met. For instance if an error state is detected, the program can be stopped with a Popup node.
- **Distance** This node can be used to stop a Direction move when the robot has moved a certain distance. The velocity is ramped down so the robot stops exactly at the distance.
- **Expression** This node can be used to stop the motion due to a custom program expression. You can use I/Os, variables or script functions to specify the stop condition.
- **I/O Input** You can use this node to stop a signal controlled motion on an I/O Input.

14.10 Command: Wait

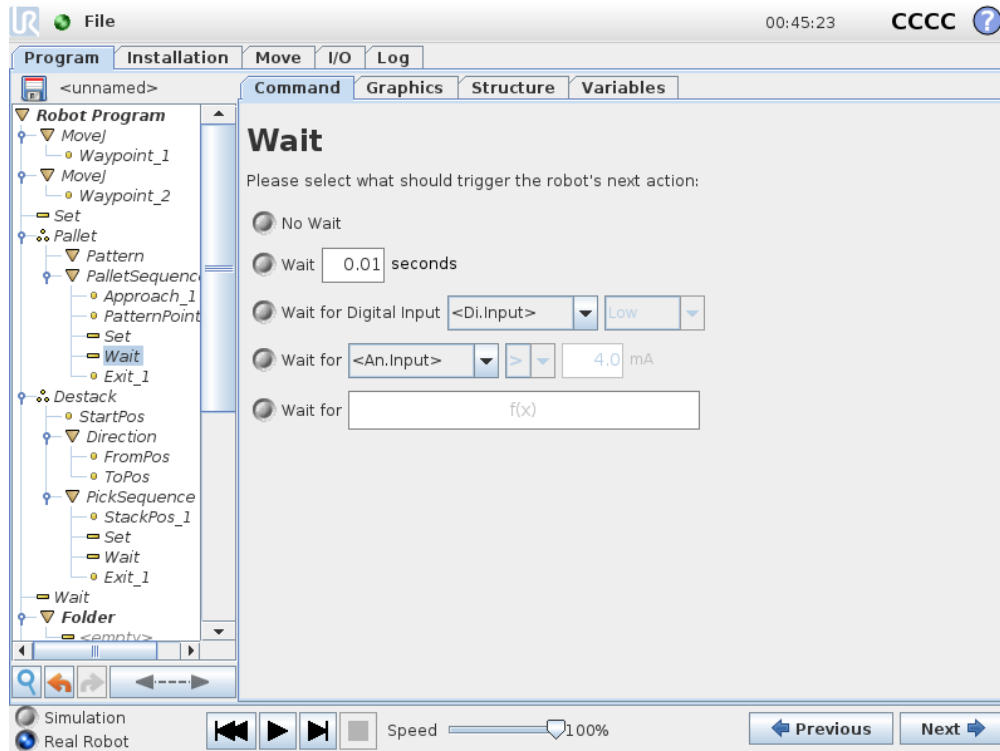

Wait pauses I/O signal, or expression, for a given amount of time. If **No Wait** is selected, nothing is done.

14.11 Command: Set

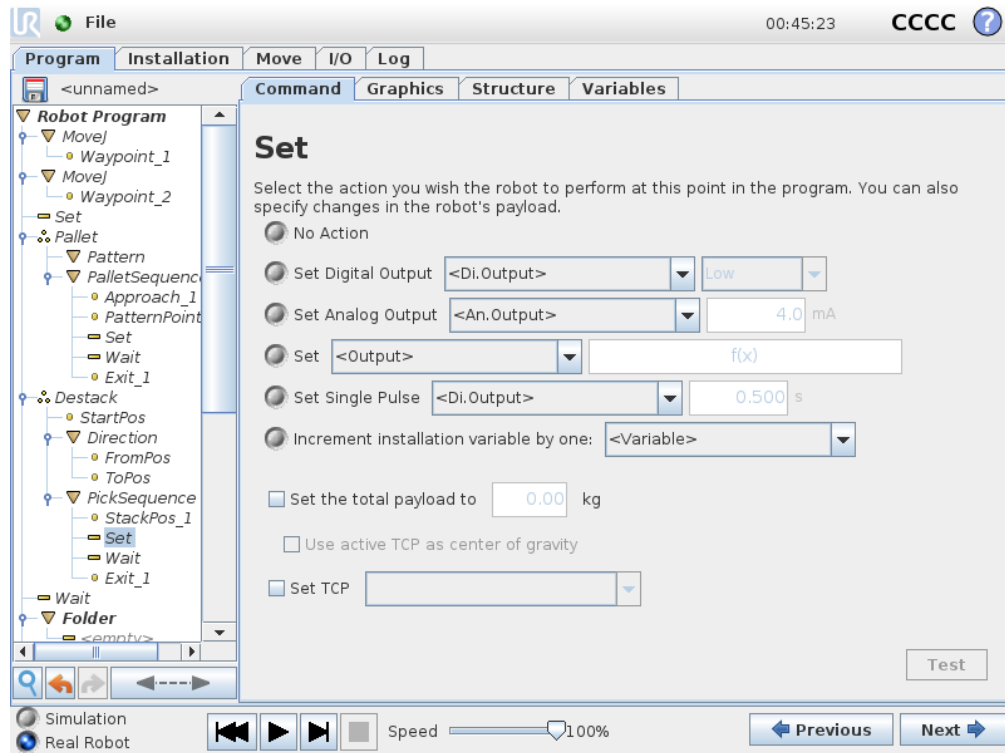

Sets either digital or analog outputs to a given value. Digital outputs can also be set to send a single pulse.

Use the Set command to set the payload of the Robot Arm. You can adjust the payload weight to prevent the robot from triggering a protective stop, when the weight at the tool differs from the expected payload. If the active TCP should not be used as the center of gravity the checkbox must be unchecked.

The active TCP can also be modified using a **Set** command, by selecting the check box and choosing one of the TCP offsets from the menu.

If the active TCP for a particular motion is known at the time of writing of the program, consider using the TCP selection on the **Move** card instead (see 14.4). For further information about configuring named TCPs (see 13.6).

14.12 Command: Popup

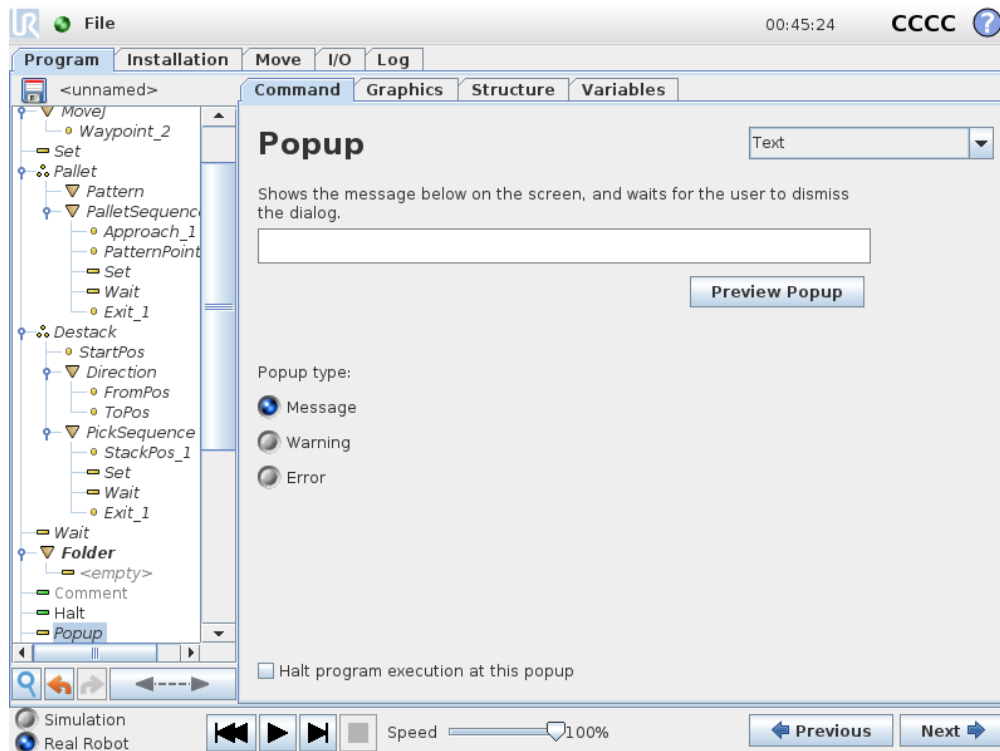

The popup is a message that appears on the screen when the program reaches this command. The style of the message can be selected, and the text itself can be given using the on-screen keyboard. The robot waits for the user/operator to press the “OK” button under the popup before continuing the program. If the “Halt program execution” item is selected, the robot program halts at this popup.

Note: Messages are limited to a maximum of 255 characters.

14.13 Command: Halt

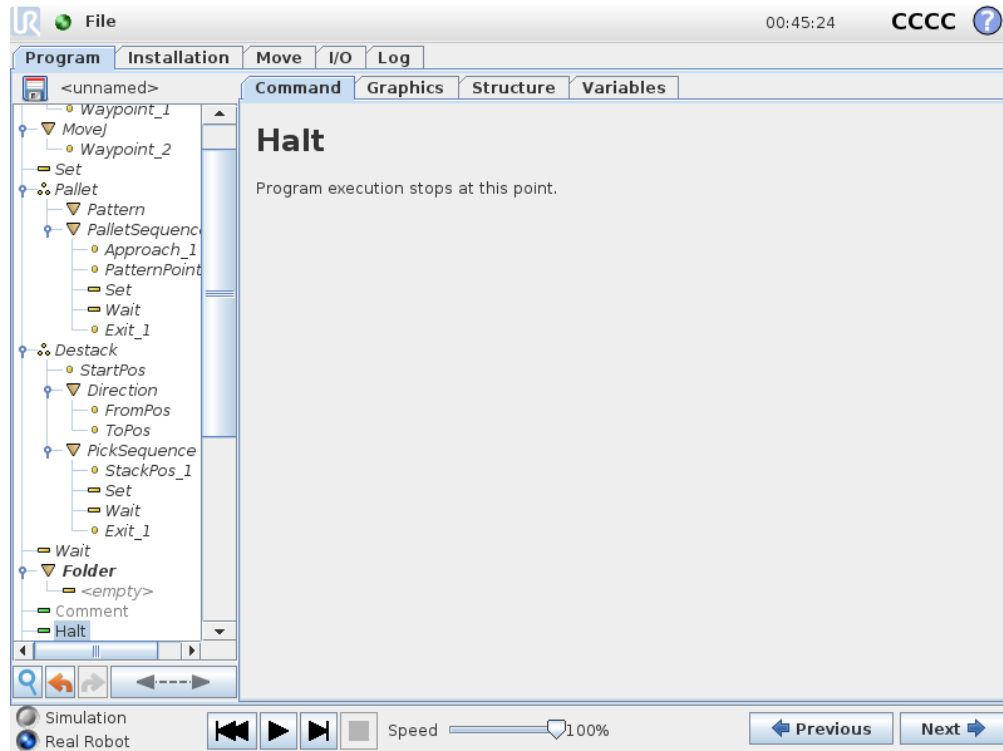

The program execution stops at this point.

14.14 Command: Comment

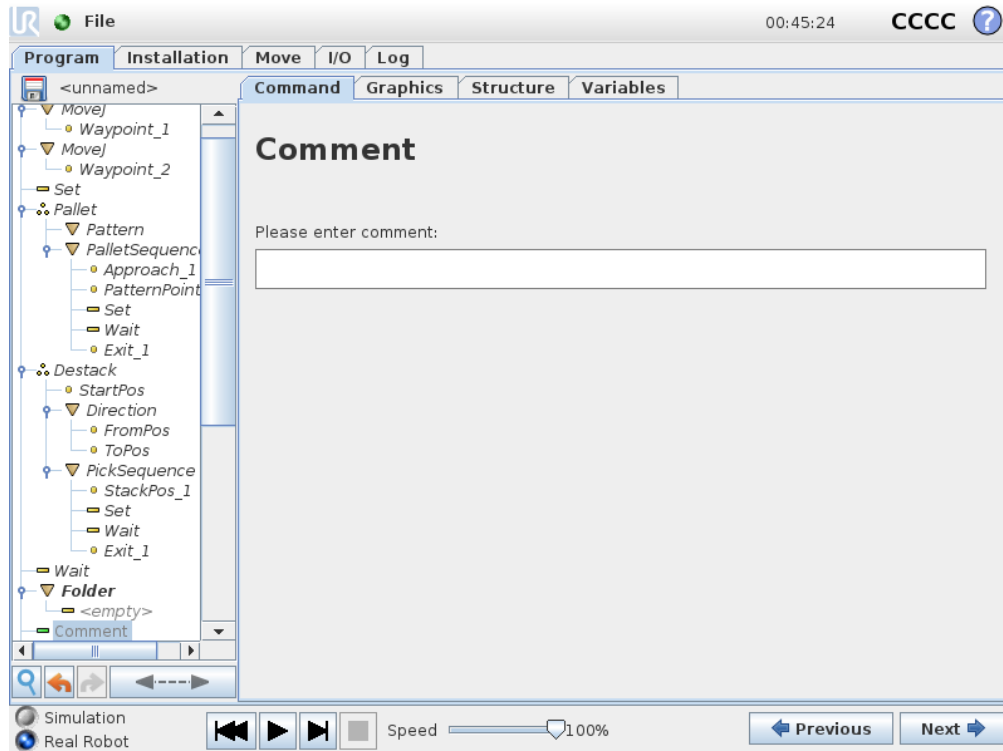

Gives the programmer an option to add a line of text to the program. This line of text does not do anything during program execution.

14.15 Command: Folder

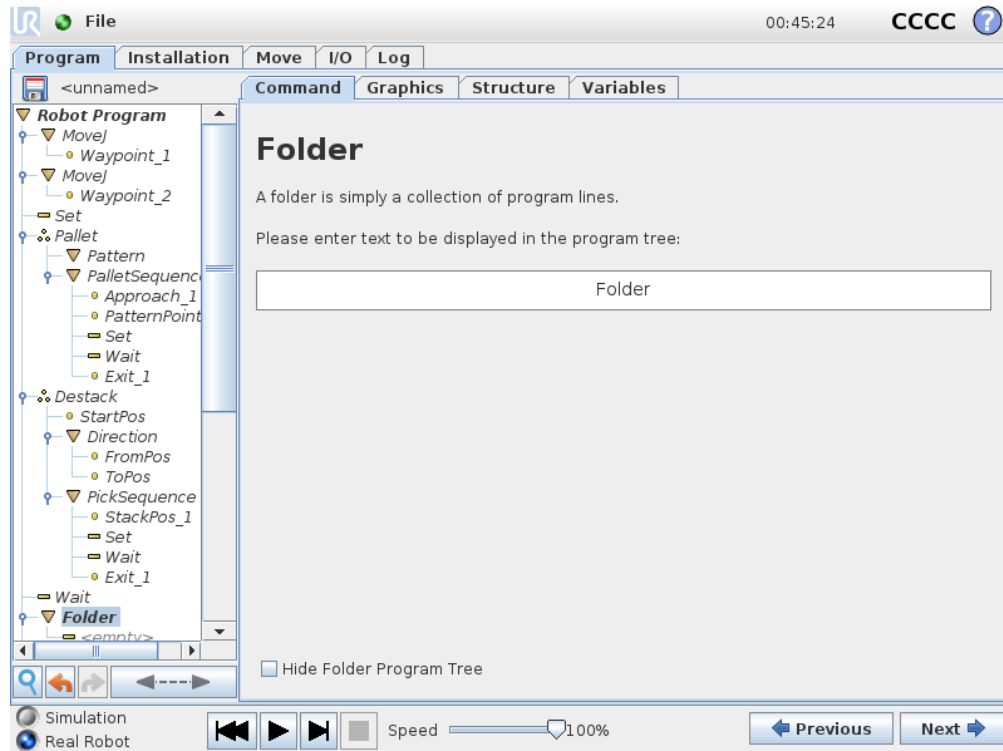

A **Folder** is used to organize and label specific parts of a program, to clean up the program tree, and to make the program easier to read and navigate.

Folders have no impact on the program and its execution.

14.16 Command: Loop

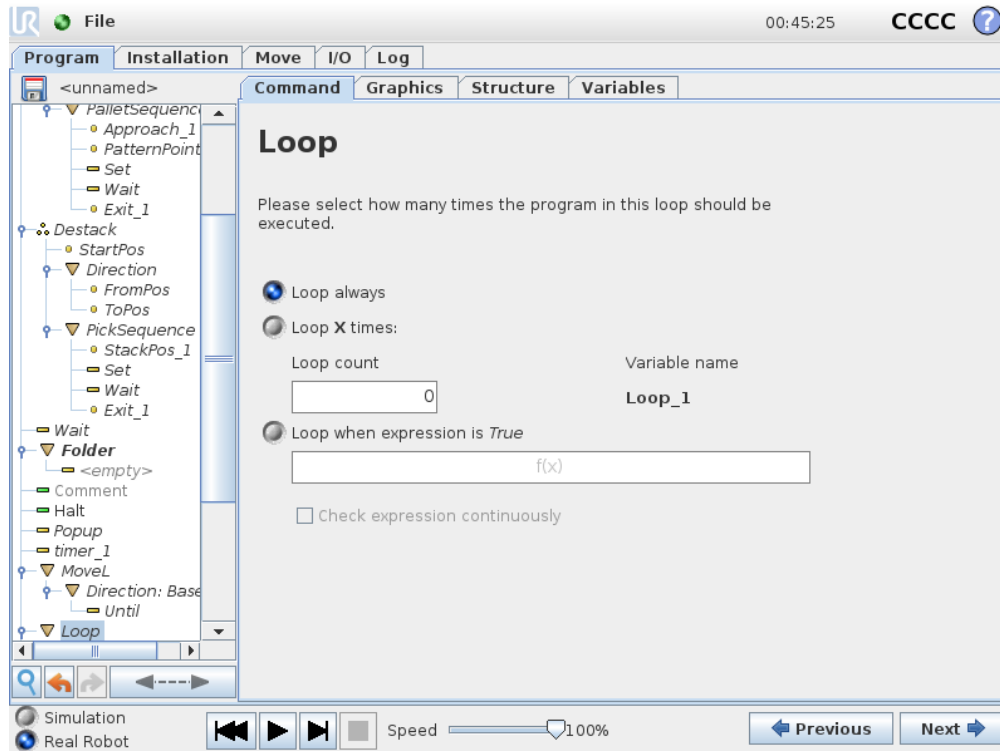

Loops the underlying program commands. Depending on the selection, the underlying program commands are either looped infinitely, a certain number of times or as long as the given condition is true. When looping a certain number of times, a dedicated loop variable (called `loop_1` in the screen shot above) is created, which can be used in expressions within the loop. The loop variable counts from 0 to $N - 1$.

When looping using an expression as end condition, PolyScope provides an option for continuously evaluating that expression, so that the “loop” can be interrupted anytime during its execution, rather than just after each iteration.

14.17 Command: If

If and If...Else statements change the robot’s behavior based on sensor inputs or variable values.

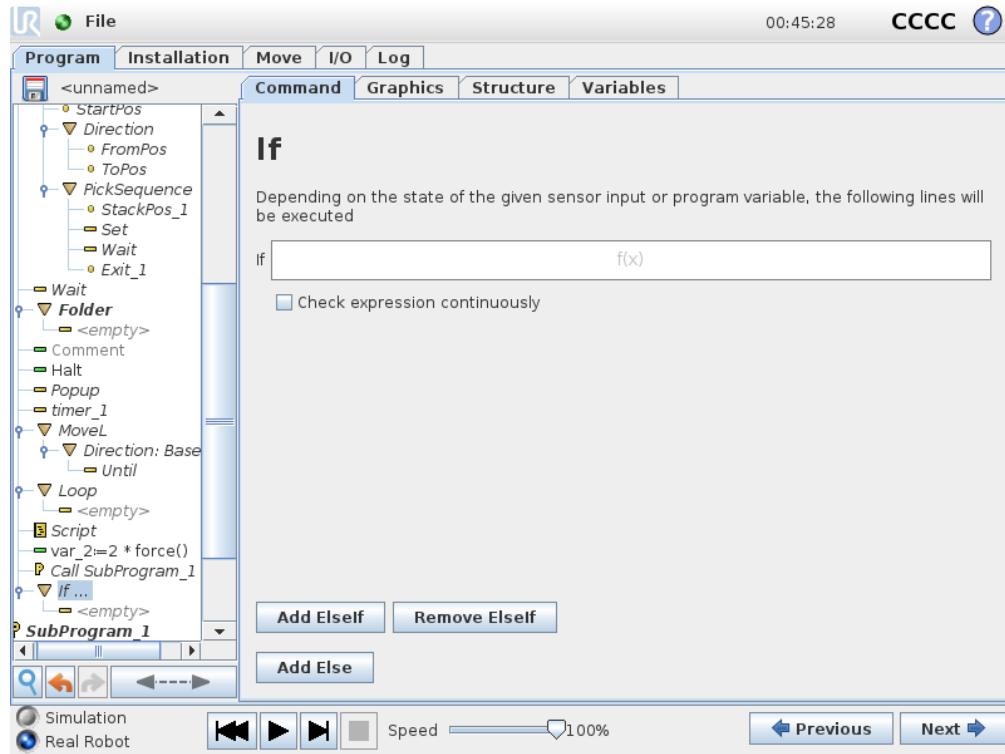

Select conditions in the Expression Editor that make up expressions using an If statement. If a condition is evaluated as True, the statements within this If command are executed. An If statement can have only one Else statement. Use Add ElseIf and Remove ElseIf to add and remove ElseIf expressions.

Select Check Expression Continuously to allow If, ElseIf and Loop statements to be evaluated while the contained lines are executed. If an expression inside an If statement is evaluated as False, the ElseIf or Else statements are followed.



NOTE:

If there are waypoints inside an If expression or inside a Loop expression with the Check Expression Continuously option, you can add a stopj() or stopl() after the expression to gently decelerate the robot arm. This is valid for both If and Loop Commands (see section 14.16).

Copyright © 2009–2019 by Universal Robots A/S. All rights reserved.

14.18 Command: SubProgram

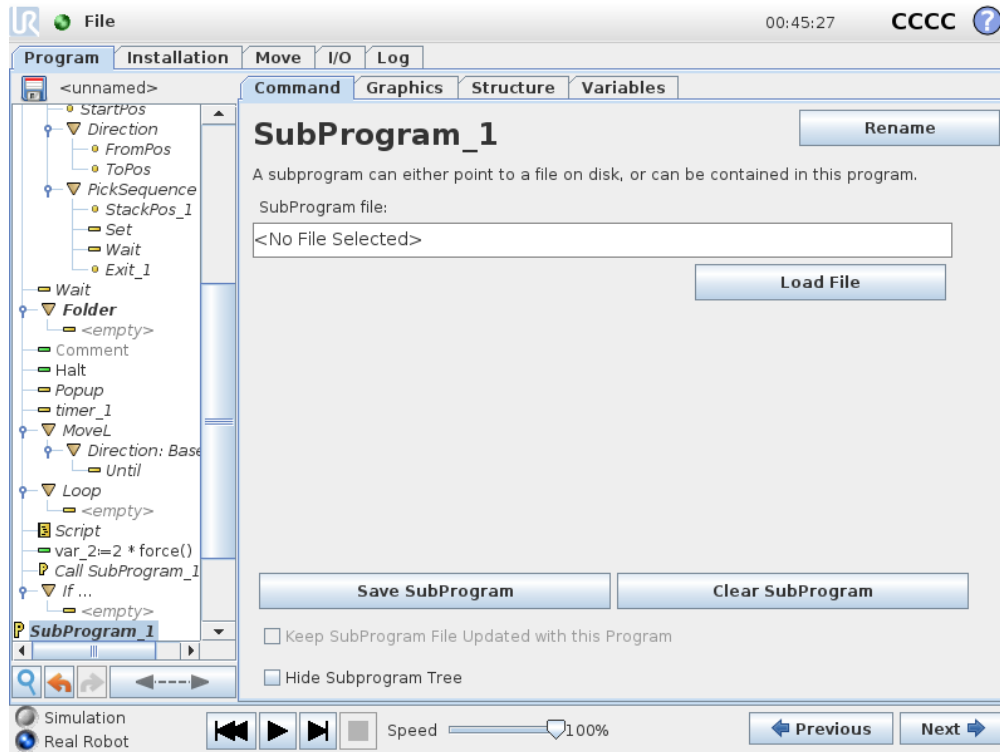

A Sub Program can hold program parts that are needed several places. A Sub Program can be a separate file on the disk, and can also be hidden to protect against accidental changes to the SubProgram.

Command: Call SubProgram

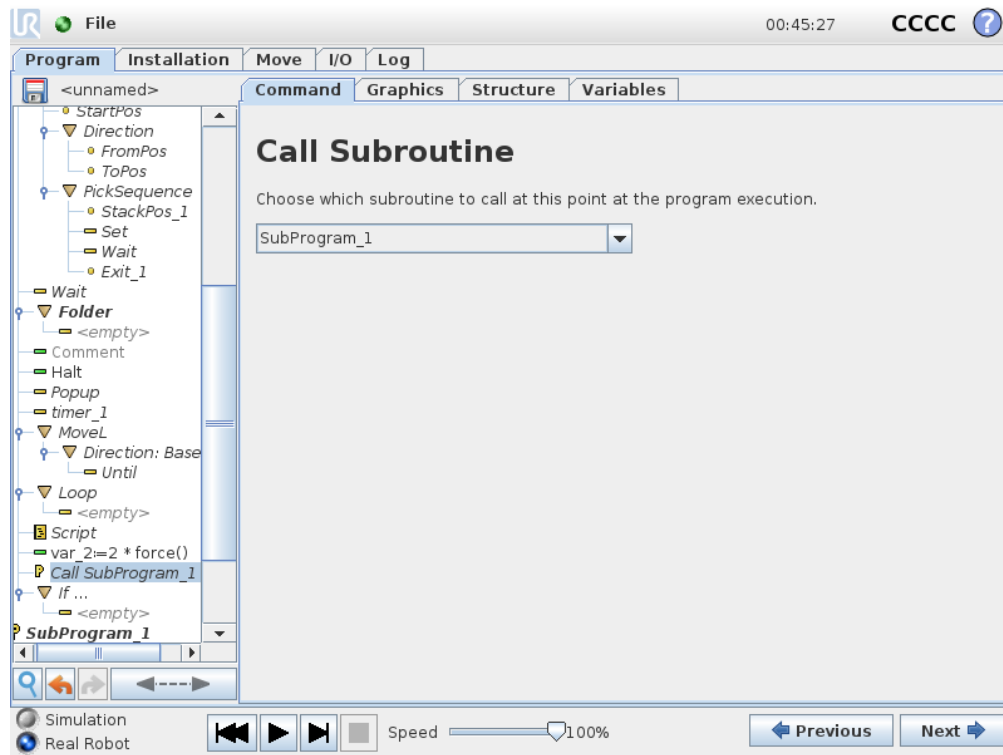

A call to a sub program will run the program lines in the sub program, and then return to the following line.

14.19 Command: Assignment

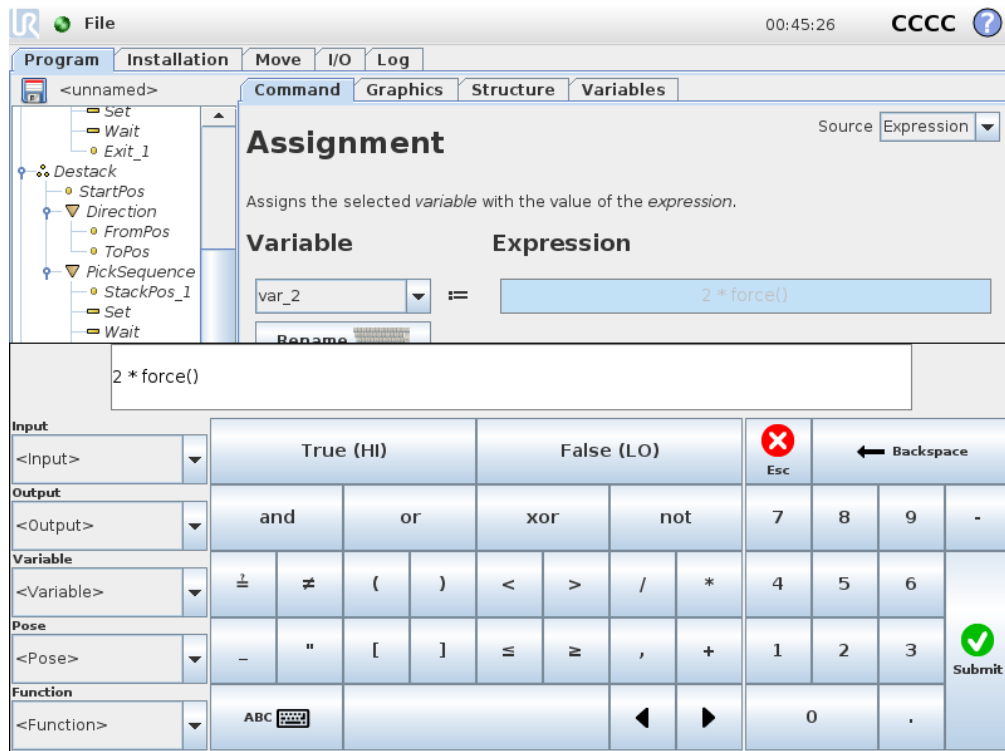

Assigns values to variables. An assignment puts the computed value of the right hand side into the variable on the left hand side. This can be useful in complex programs.

14.20 Command: Script

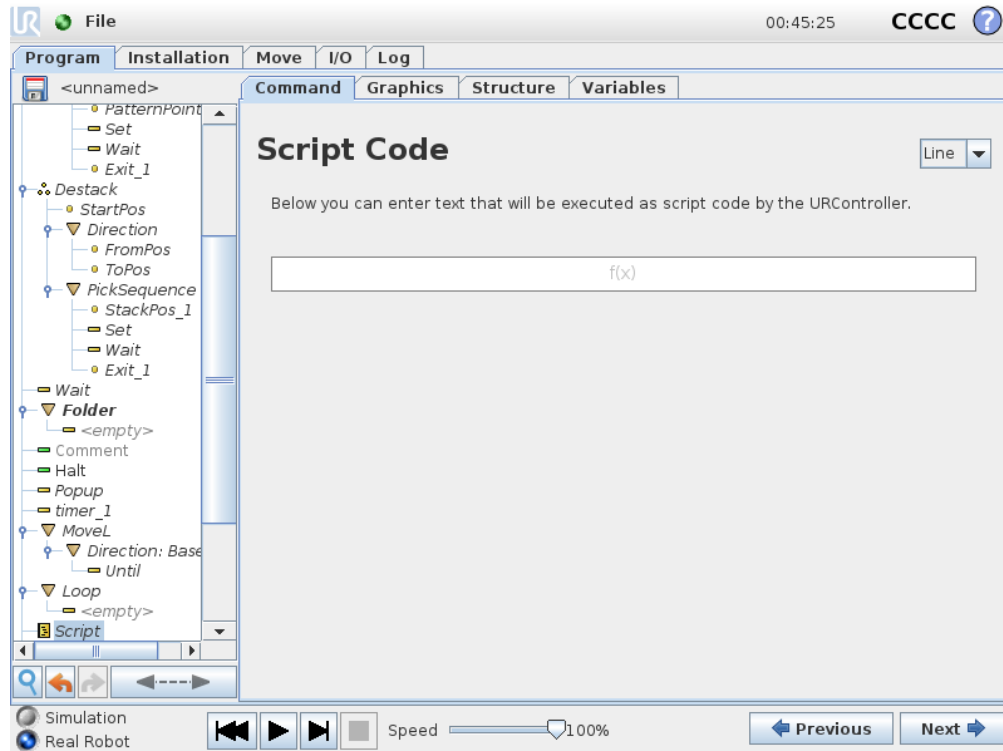

The following options are available in the drop down list under Command:

- **Line** allows you to write a single line of URscript code, using the Expression Editor (12.1)
- **File** allows you to write, edit or load URscript files.

You can find instructions for writing URscript in the Script Manual on the support website (<http://www.universal-robots.com/support>).

Functions and variables declared in a URscript file are available for use throughout the program in the PolyScope.

14.21 Command: Event

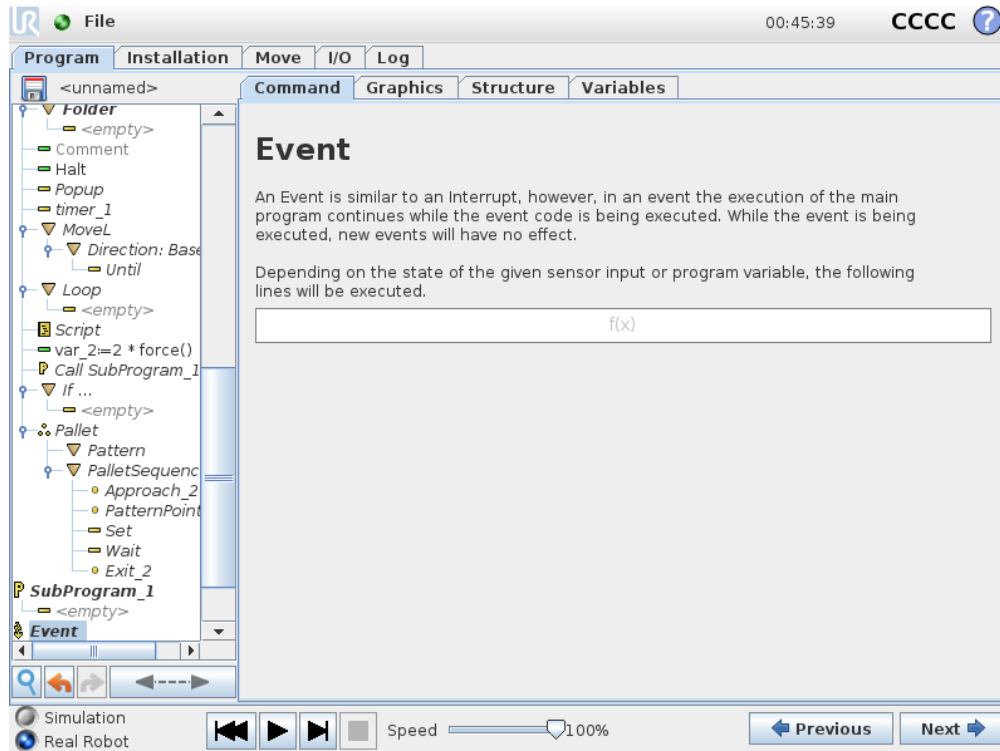

An event can be used to monitor an input signal, and perform some action or set a variable when that input signal goes high. For example, in the event that an output signal goes high, the event program can wait for 200ms and then set it back to low again. This can make the main program code a lot simpler in the case on an external machine triggering on a rising flank rather than a high input level. Events are checked once every control cycle (8ms).

14.22 Command: Thread

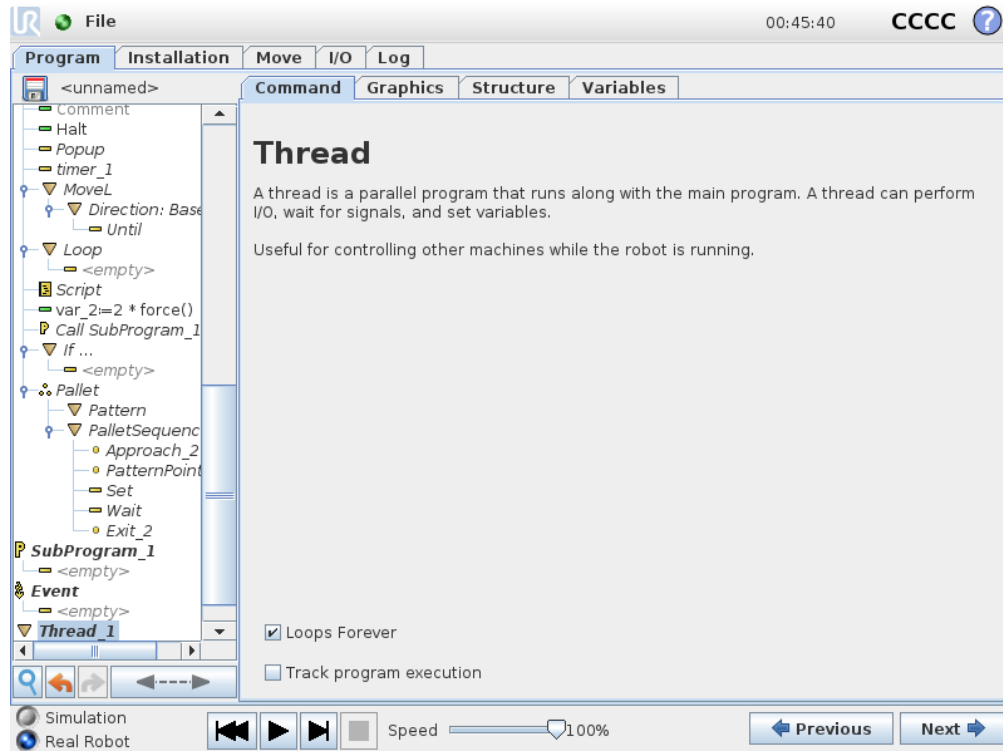

A thread is a parallel process to the robot program. A thread can be used to control an external machine independently of the robot arm. A thread can communicate with the robot program with variables and output signals.

14.23 Command: Switch

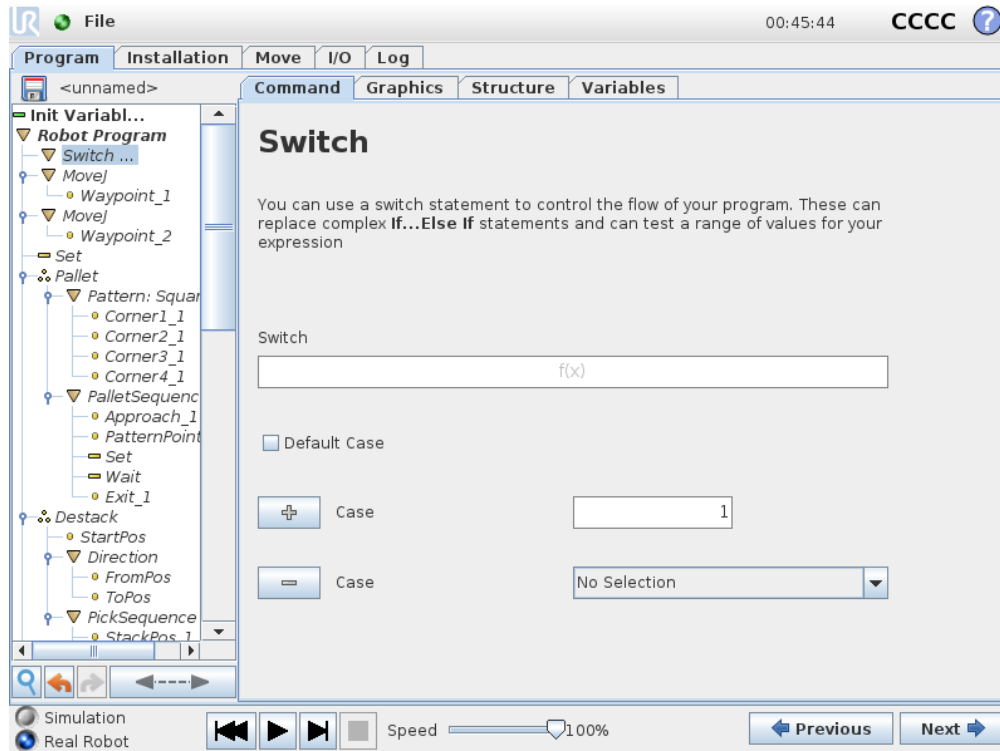

A **Switch Case** construction can make the robot change behavior based on sensor inputs or variable values. Use the **Expression Editor** to describe the base condition and define the cases under which the robot should proceed to the sub-commands of this **Switch**. If the condition is evaluated to match one of the cases, the lines inside the **Case** are executed. If a **Default Case** has been specified, then the lines will be executed only if no other matching cases were found.

Each **Switch** can have several **Cases** and one **Default Case**. **Switches** can only have one instance of any **Case** values defined. **Cases** can be added using the buttons on the screen. A **Case** command can be removed from the screen for that switch.

14.23.1 Timer

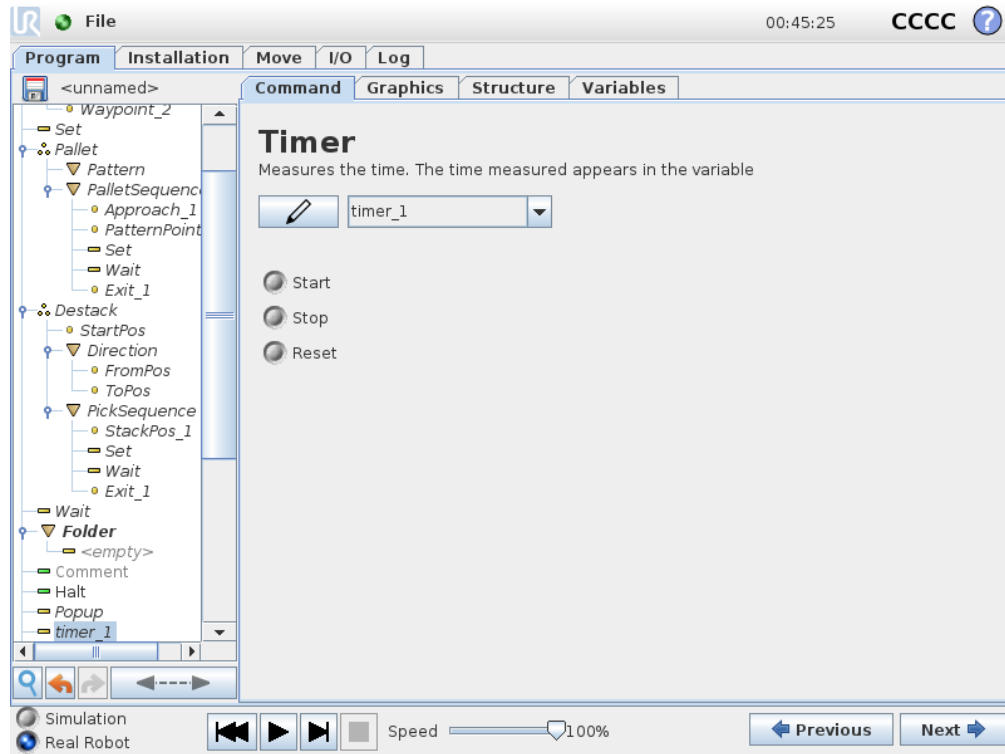

A Timer measures the length of time it takes for specific parts of the program to run. A program variable contains the time passed since a Timer started, and can be seen in the Variables Tab and in the Run Tab.

14.24 Command: Pattern

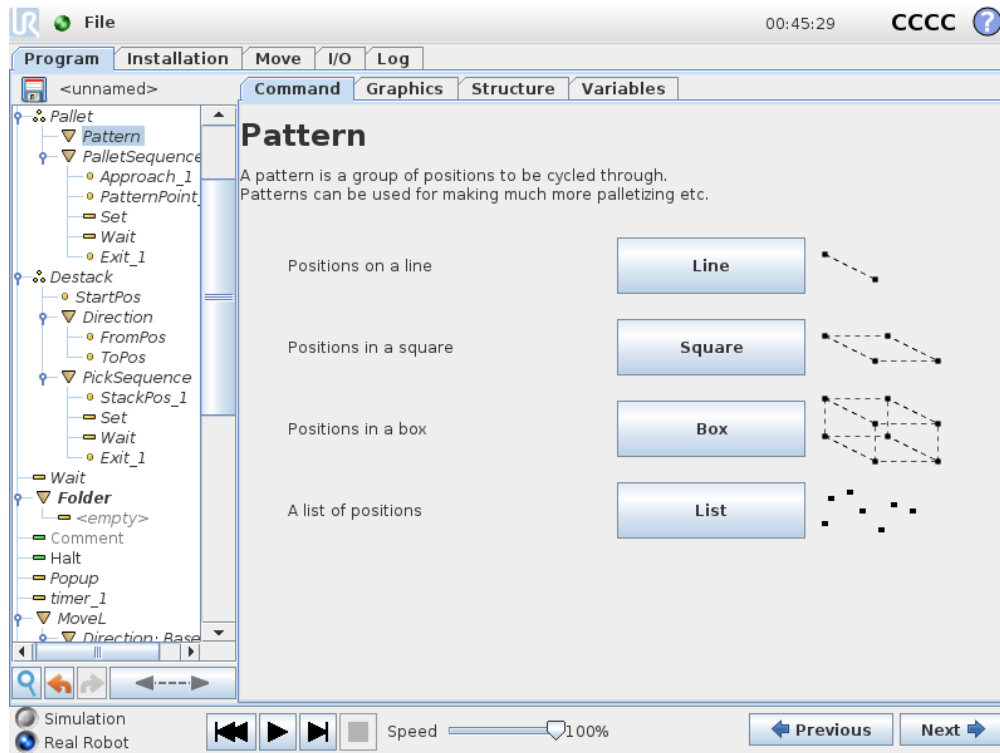

The **Pattern** command can be used to cycle through positions in the robot program. The **Pattern** command corresponds to one position at each execution.

A pattern can be given as one of four types. The first three, **Line**, **Square** or **Box** can be used for positions in a regular pattern. The regular patterns are defined by a number of characteristic points, where the points define the edges of the pattern. For **Line** this is the two end points, for **Square** this is three of the four corner points, where as for **Box** this is four of the eight corner points. The programmer enters the number of positions along each of the edges of the pattern. The robot controller then calculates the individual pattern positions by proportionally adding the edge vectors together.

If the positions to be traversed do not fall in a regular pattern, the **List** option can be chosen, where a list of all the positions is provided by the programmer. This way any kind of arrangement of the positions can be realized.

Defining the Pattern

When the **Box** pattern is selected, the screen changes to what is shown below.

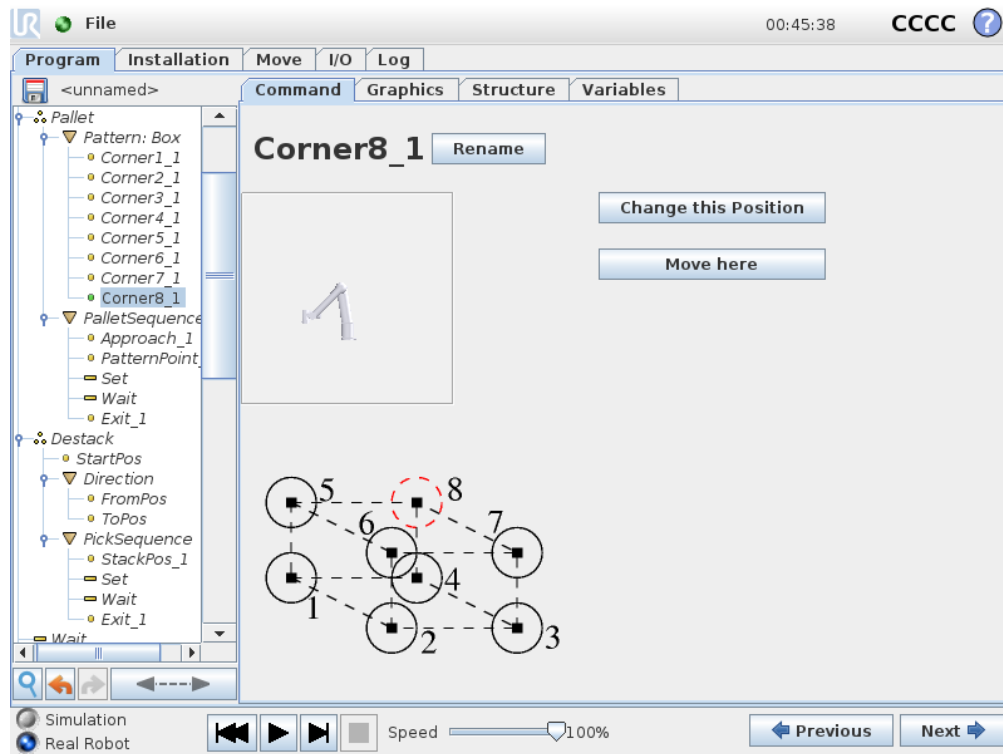

A **Box** pattern uses three vectors to define the side of the box. These three vectors are given as four points, where the first vector goes from point one to point two, the second vector goes from point two to point three, and the third vector goes from point three to point four. Each vector is divided by the interval count numbers. A specific position in the pattern is calculated by simply adding the interval vectors proportionally.

The **Line** and **Square** patterns work similarly.

A counter variable is used while traversing the positions of the pattern. The name of the variable can be seen on the **Pattern** command screen. The variable cycles through the numbers from 0 to $X * Y * Z - 1$, the number of points in the pattern. This variable can be manipulated using assignments, and can be used in expressions.

14.25 Command: Force

In the robot workspace **Force mode** allows for compliance and force in selectable axes. All robot arm movements under a **Force** command are in **Force mode**. When the robot arm is moving in **Force mode**, it is possible to select one or more axes where the robot arm is compliant. The robot arm complies with the environment along a compliant axes. This means the robot arm automatically adjusts its position in order to achieve the desired force. It is also possible to make the robot arm itself apply a force to its environment, e.g. a workpiece.

Force mode is suited to applications where the actual TCP position along a predefined axis is not important, but instead a desired force along that axis is required. For example if the robot TCP rolls against a curved surface, pushes or pulls a workpiece. **Force mode** also supports applying certain torques around predefined axes.

Note: if no obstacles are met in an axis where a non-zero force is set, the robot arm attempts to accelerate along that axis.

Although an axis is selected to be compliant, the robot program still tries to move the robot along that axis. However, force control assures that the robot arm still approaches the specified force.

**NOTE:**

If there is a Force node inside an If, ElseIf or Loop, and the Check Expression Continuously option is selected, you can add an `end_force_mode()` script at the end of the expression to exit force control.

**WARNING:**

1. Avoid high deceleration just before entering force mode.
2. Avoid high acceleration in force mode, since it decreases force control accuracy.
3. Avoid movements parallel to compliant axes before entering force mode.

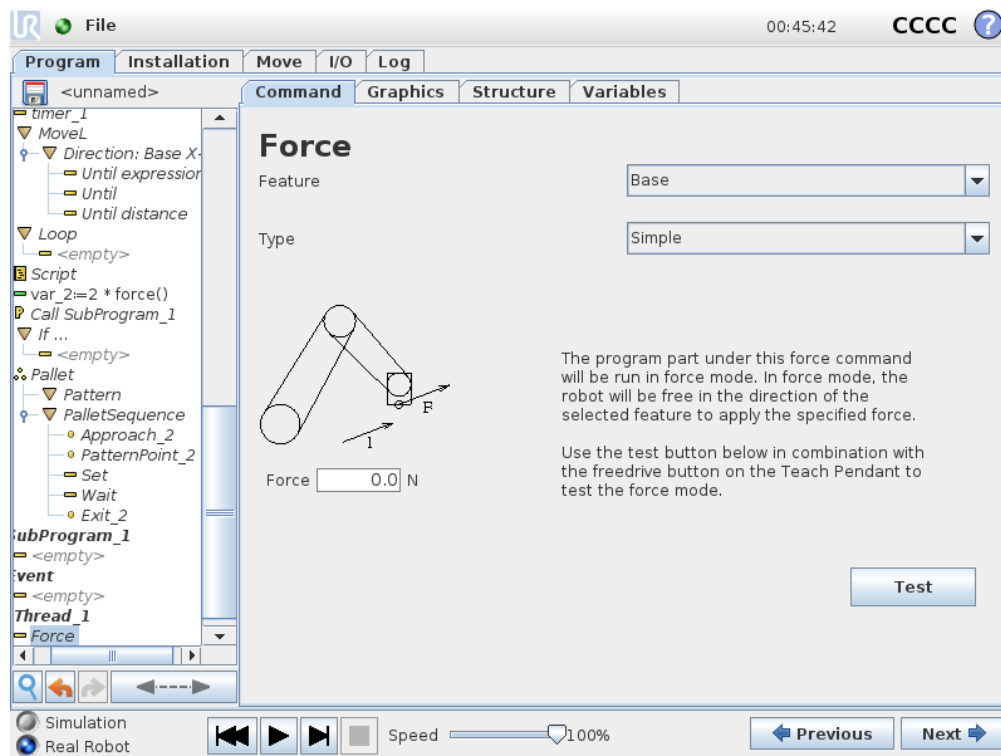

Feature selection

The **Feature menu** is used to select the coordinate system (axes) the robot will use while it is operating in force mode. The features in the menu are those which have been defined in the installation (see 13.12).

Force mode type

There are four different types of force mode each determining the way in which the selected feature will be interpreted.

- **Simple:** Only one axis will be compliant in force mode. The force along this axis is adjustable. The desired force will always be applied along the z-axis of the selected feature. However, for Line features, it is along their y-axis.
- **Frame:** The Frame type allows for more advanced usage. Here, compliance and forces in all six degrees of freedom can be independently selected.
- **Point:** When Point is selected, the task frame has the y-axis pointing from the robot TCP towards the origin of the selected feature. The distance between the robot TCP and the origin of the selected feature is required to be at least 10 mm. Note that the task frame will change at runtime as the position of the robot TCP changes. The x- and z-axis of the task frame are dependent on the original orientation of the selected feature.
- **Motion:** Motion means that the task frame will change with the direction of the TCP motion. The x-axis of the task frame will be the projection of the TCP movement direction onto the plane spanned by the x- and y-axis of the selected feature. The y-axis will be perpendicular to the robot arm's motion, and in the x-y plane of the selected feature. This can be useful when de-burring along a complex path, where a force is needed perpendicular to the TCP motion. Note: when the robot arm is not moving: If force mode is entered with the robot arm standing still, there will be no compliant axes until the TCP speed is above zero. If later, while still in force mode, the robot arm is again standing still, the task frame has the same orientation as the last time the TCP speed was larger than zero.

For the last three types, the actual task frame can be viewed at runtime on the graphics tab (see 14.30), when the robot is operating in force mode.

Force value selection

- Force or torque value can be set for compliant axes, and robot arm adjusts its position to achieve the selected force.
- For non-compliant axes robot arm will follow the trajectory set by the program.

For translational parameters, the force is specified in Newtons [N] and for rotational the torque is specified in Newton meters [Nm].

**NOTE:**

You must do the following:

- Use `get_tcp_force()` script function in separate thread, to read actual force and torque.
- Correct wrench vector, if actual force and/or torque is lower than requested.

Limits selection

For all axes a limit can be set, but these have different meaning corresponding to the axes being compliant or non-compliant.

- **Compliant:** The limit is the maximum speed the TCP is allowed to attain along/about the axis. Units are [mm/s] and [deg/s].
- **Non-compliant:** The limit is the maximum deviation from the program trajectory which is allowed before the robot protective stops. Units are [mm] and [deg].

Test force settings

The on/off button, labelled **Test**, toggles the behavior of the **Freedrive** button on the back of the Teach Pendant from normal Freedrive mode to testing the force command.

When the **Test button** is on and the **Freedrive** button on the back of the Teach Pendant is pressed, the robot will perform as if the program had reached this force command, and this way the settings can be verified before actually running the complete program. Especially, this possibility is useful for verifying that compliant axes and forces have been selected correctly. Simply hold the robot TCP using one hand and press the **Freedrive** button with the other, and notice in which directions the robot arm can/cannot be moved. Upon leaving this screen, the Test button automatically switches off, which means the **Freedrive** button on the back of the Teach Pendant is again used for regular **Freedrive** mode.

Note: The **Freedrive** button will only be effectual when a valid feature has been selected for the Force command.

14.26 Command: Pallet

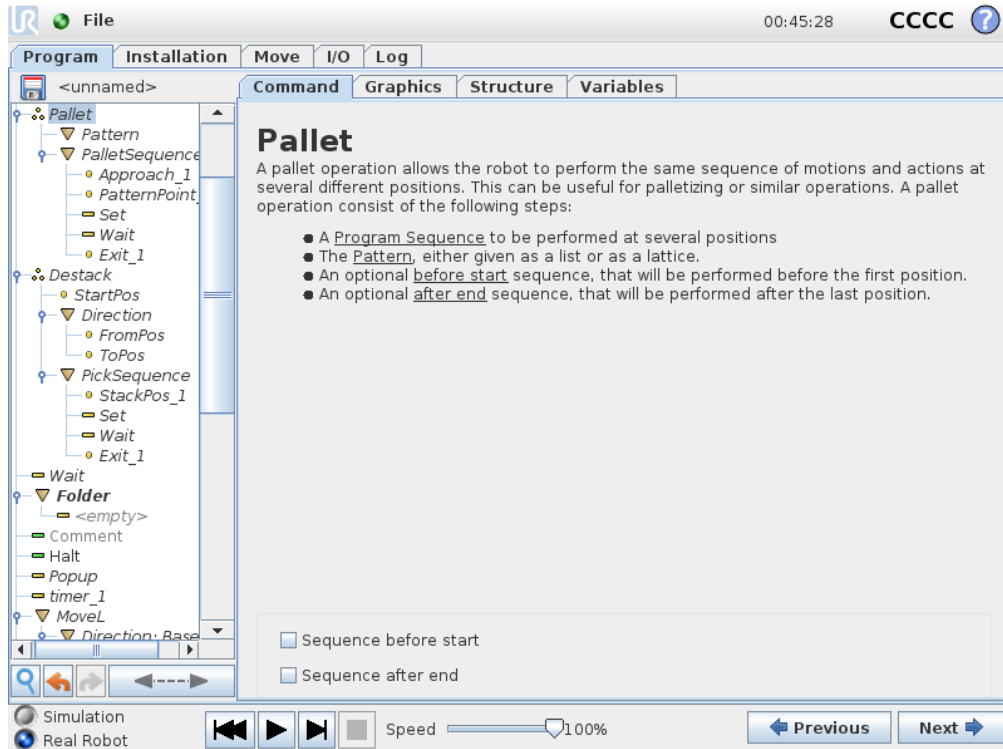

A pallet operation can perform a sequence of motions in a set of places given as a pattern (see 14.24). At each of the positions in the pattern, the sequence of motions will be run relative to the pattern position.

Programming a Pallet Operation

1. Define the pattern.
2. Make a **PalletSequence** for picking up/placing at each single point. The sequence describes what should be done at each pattern position.
3. Use the selector on the sequence command screen to define which of the waypoints in the sequence should correspond to the pattern positions.

Pallet Sequence/Anchorable Sequence

In a **Pallet Sequence** node, the motions of the robot arm are relative to the pallet position. The behavior of a sequence is such that the robot arm will be at the position specified by the pattern at the **Anchor Position/Pattern Point**. The remaining positions will all be moved to make this fit. Do not use the **Move** command inside a sequence, as it will not be relative to the anchor position.

“BeforeStart”

The optional **BeforeStart** sequence is run just before the operation starts. This can be used to wait for ready signals.

“AfterEnd”

The optional **AfterEnd** sequence is run when the operation is finished. This can be used to signal conveyor motion to start, preparing for the next pallet.

14.27 Command: Seek

A seek function uses a sensor to determine when the correct position is reached to grab or drop an item. The sensor can be a push button switch, a pressure sensor or a capacitive sensor. This function is made for working on stacks of items with varying item thickness, or where the exact positions of the items are not known or too hard to program.

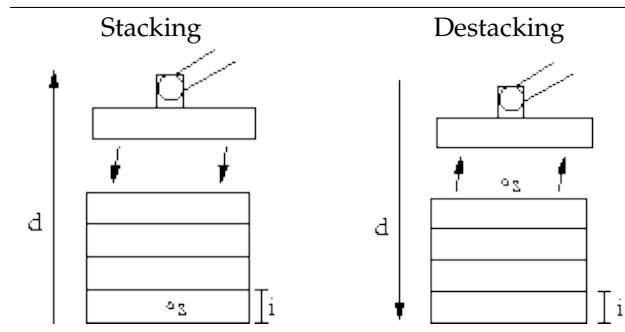

When programming a seek operation for working on a stack, one must define s the starting point, d the stack direction and i the thickness of the items in the stack.

On top of this, one must define the condition for when the next stack position is reached, and a special program sequence that will be performed at each of the stack positions. Also speed and accelerations need to be given for the movement involved in the stack operation.

Stacking

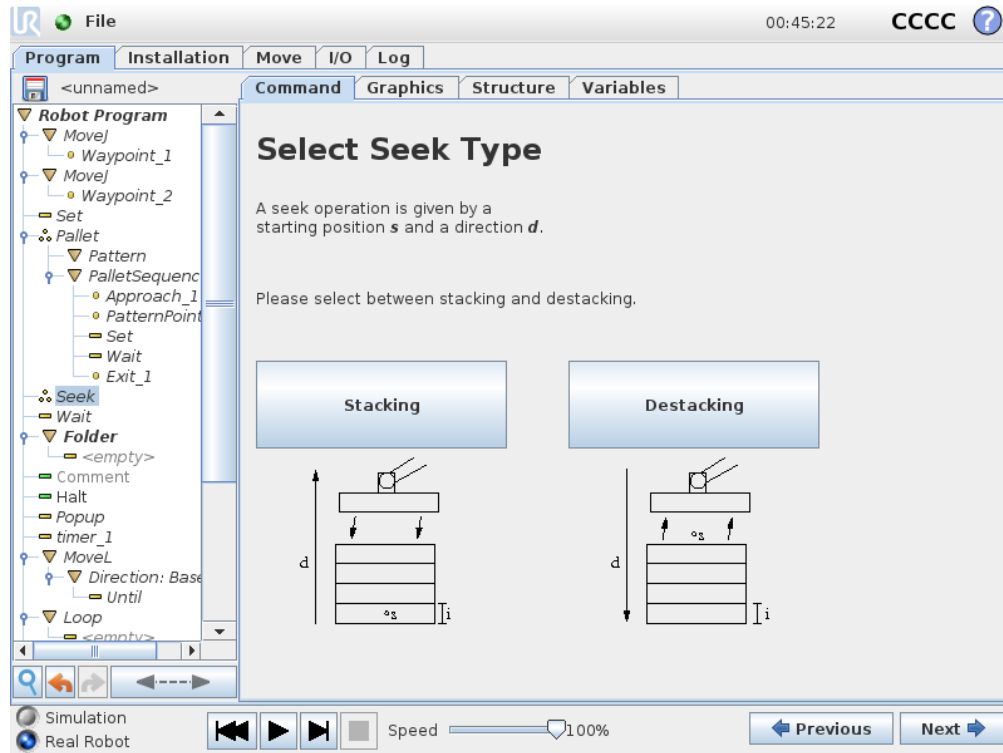

When stacking, the robot arm moves to the starting position, and then moves *opposite* the direction to search for the next stack position. When found, the robot remembers the position and performs the special sequence. The next time round, the robot starts the search from the remembered position incremented by the item thickness along the direction. The stacking is finished when the stack height is more than some defined number, or when a sensor gives a signal.

Destacking

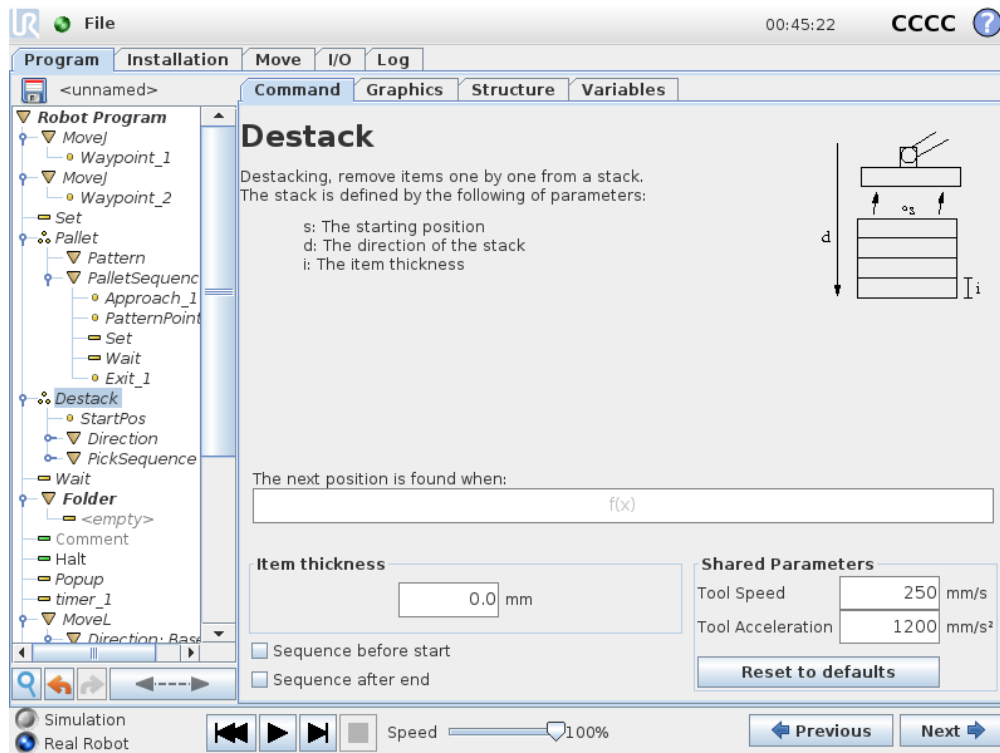

When destacking, the robot arm moves from the starting position in the given direction to search for the next item. The condition on the screen determines when the next item is reached. When the condition becomes satisfied, the robot remembers the position and performs the special sequence. The next time round, the robot starts the search from the remembered position, incremented by the item thickness along the direction.

Starting position

The starting position is where the stack operation starts. If the starting position is omitted, the stack starts at the robot arm's current position.

Direction

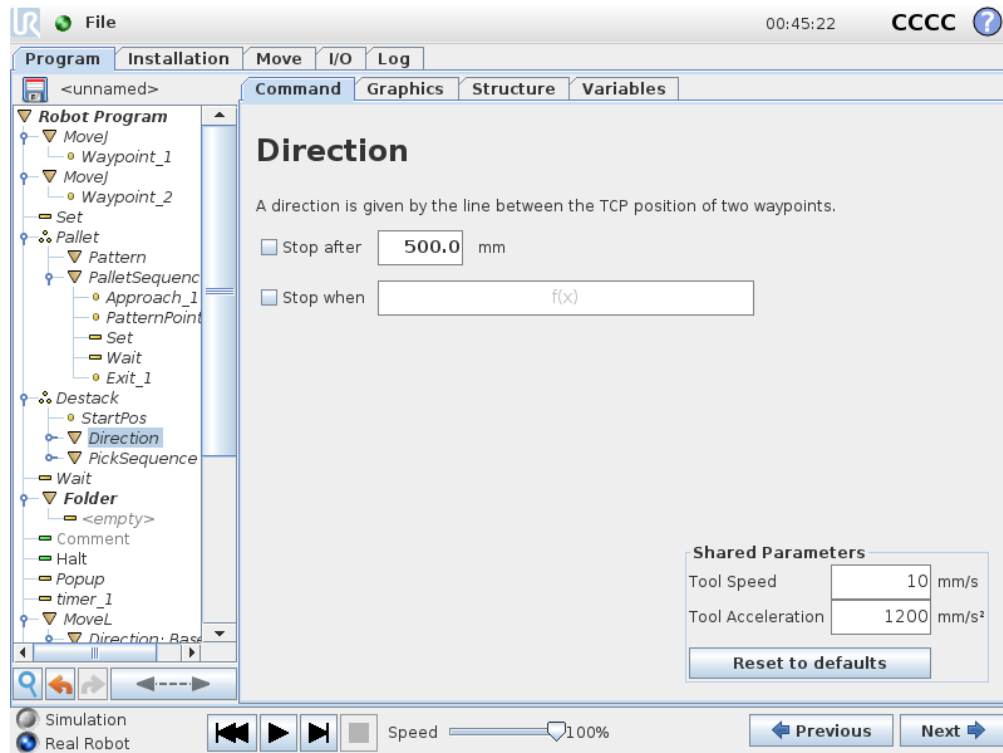

The direction is given by two positions, and is calculated as the position difference from the first positions TCP to the second positions TCP.

Note: A direction does not consider the orientations of the points.

Next Stacking Position Expression

The robot arm moves along the direction vector while continuously evaluating whether the next stack position has been reached. When the expression is evaluated to `True` the special sequence is executed.

“BeforeStart”

The optional `BeforeStart` sequence is run just before the operation starts. This can be used to wait for ready signals.

“AfterEnd”

The optional `AfterEnd` sequence is run when the operation is finished. This can be used to signal conveyor motion to start, preparing for the next stack.

Pick/Place Sequence

The Pick/Place Sequence is a special program sequence performed at each stack position, similar to the Pallet operation (see 14.26).

14.28 Command: Conveyor Tracking

The robot can be configured to track the movement of one configured conveyor (Conveyor 1). When the **Conveyor Tracking** defined in the installation is configured correctly, the robot adjusts the movements to follow the conveyor. The **Conveyor Tracking** program node is available from the **Wizards** tab under the **Structure** tab. All movements under this node are allowed while tracking the conveyor, but they are relative to the motion of the conveyor belt. The **Conveyor Tracking** setup under the **Installation** tab (see section 13.13) provides options for configuring the robot to work with absolute and incremental encoders, as well as, linear and circular conveyors.



NOTE:

The Control Box can only accommodate one incremental encoder that must be used with one conveyor (Conveyor 1).

14.29 Command: Suppress

Suppressed program lines are simply skipped when the program is run. A suppressed line can be unsuppressed again at a later time. This is a quick way to make changes to a program without destroying the original contents.

14.30 Graphics Tab

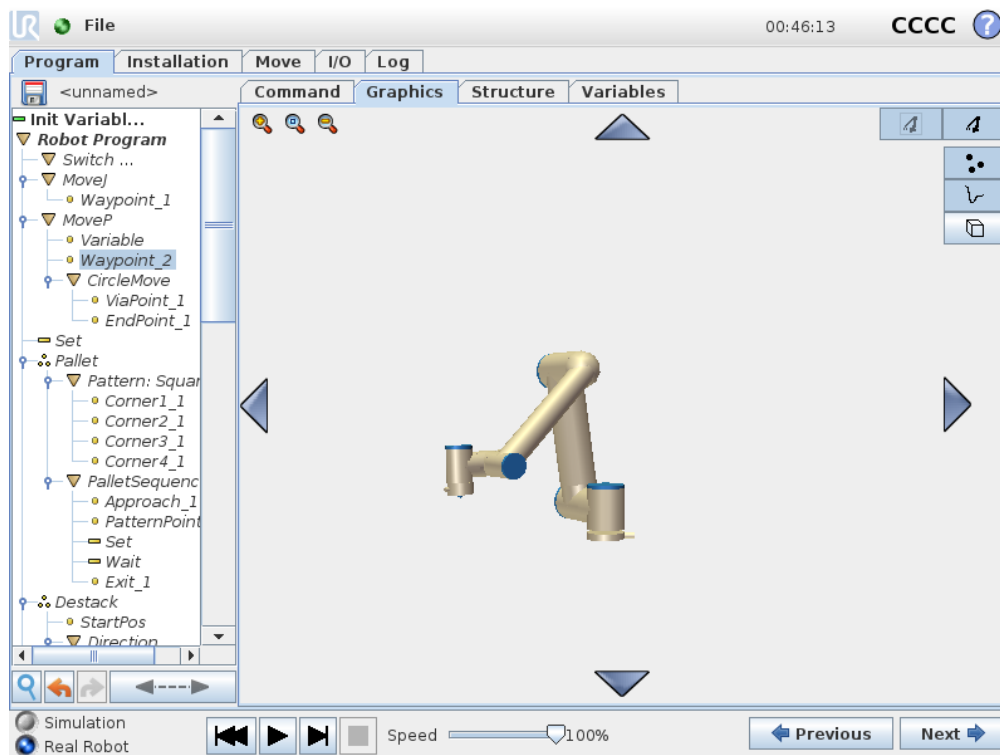

Graphical representation of the current robot program. The path of the TCP is shown in 3D view, with motion segments in black, and blend segments (transitions between motion segments) shown in green. The green dots specify the positions of the TCP at each of the waypoints in the program. The 3D drawing of the robot arm shows the current position of the robot arm, and the *shadow* of the robot arm shows how the robot arm intends to reach the waypoint selected in the left hand side of the screen.

If the current position of the robot TCP comes close to a safety or trigger plane, or the orientation of robot tool is near the tool orientation boundary limit (see 10.12), a 3D representation of the boundary limit is shown.

Note: when the robot is running a program, the visualization of boundary limits will be disabled.

Safety planes are visualized in yellow and black with a small arrow representing the plane normal, which indicates the side of the plane on which the robot TCP is allowed to be positioned. Trigger planes are displayed in blue and green and a small arrow pointing to the side of the plane, where the **Normal** mode limits (see 10.6) are active. The tool orientation boundary limit is visualized with a spherical cone together with a vector indicating the current orientation of the robot tool. The inside of the cone represents the allowed area for the tool orientation (vector).

When the target robot TCP no longer is in the proximity of the limit, the 3D representation disappears. If the TCP is in violation or very close to violating a boundary limit, the visualization of the limit turns red.

The 3D view can be zoomed and rotated to get a better view of the robot arm. The buttons in the top-right side of the screen can disable the various graphical components in 3D view. The bottom button switches on/off the visualization of proximate boundary limits. The motion segments shown depend on the selected program node. If a **MOVE** node is selected, the displayed path is the motion defined by that move. If a **Waypoint** node is selected, the display shows the following ~ 10 steps of movement.

14.31 Structure Tab

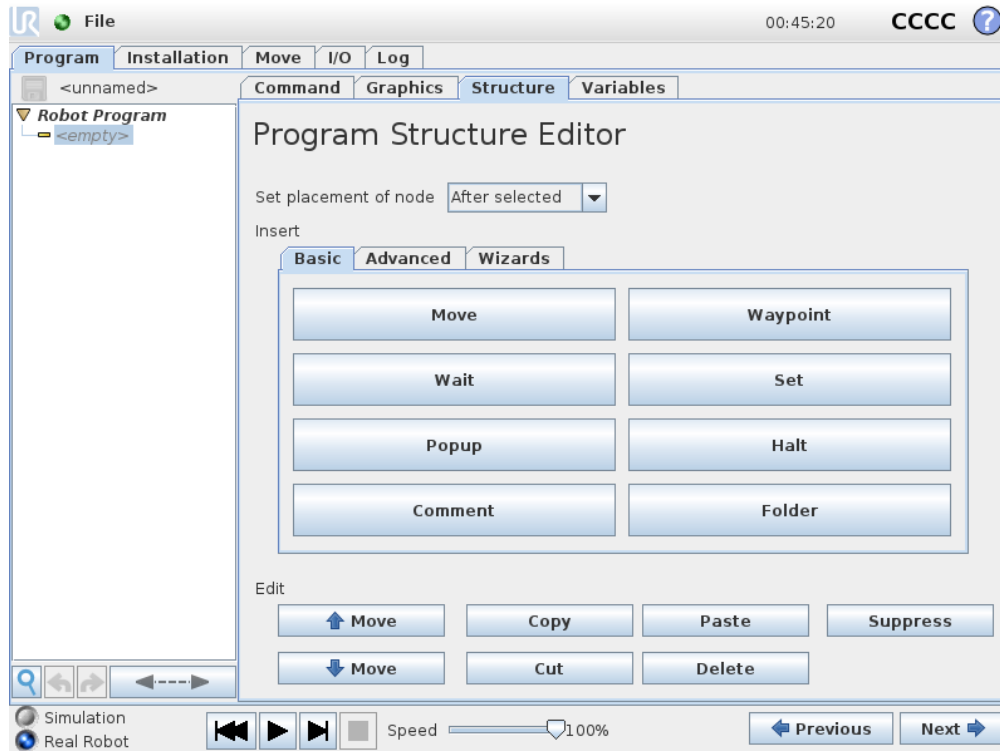

The program structure tab gives an opportunity for inserting, moving, copying and removing the various types of commands.

To insert new commands, perform the following steps:

1. Select an existing program command.
2. Select whether the new command should be inserted above or below the selected command.
3. Press the button for the command type you wish to insert. For adjusting the details for the new command, go to the Command tab.

Commands can be moved/cloned/deleted using the buttons in the edit frame. If a command has sub-commands (a triangle next to the command) all sub-commands are also moved/cloned/deleted.

Not all commands fit at all places in a program. `Waypoints` must be under a `Move` command (not necessarily directly under). `ElseIf` and `Else` commands are required to be after an `If`. In general, moving `ElseIf` commands around can be messy. Variables must be assigned values before being used.

14.32 Variables Tab

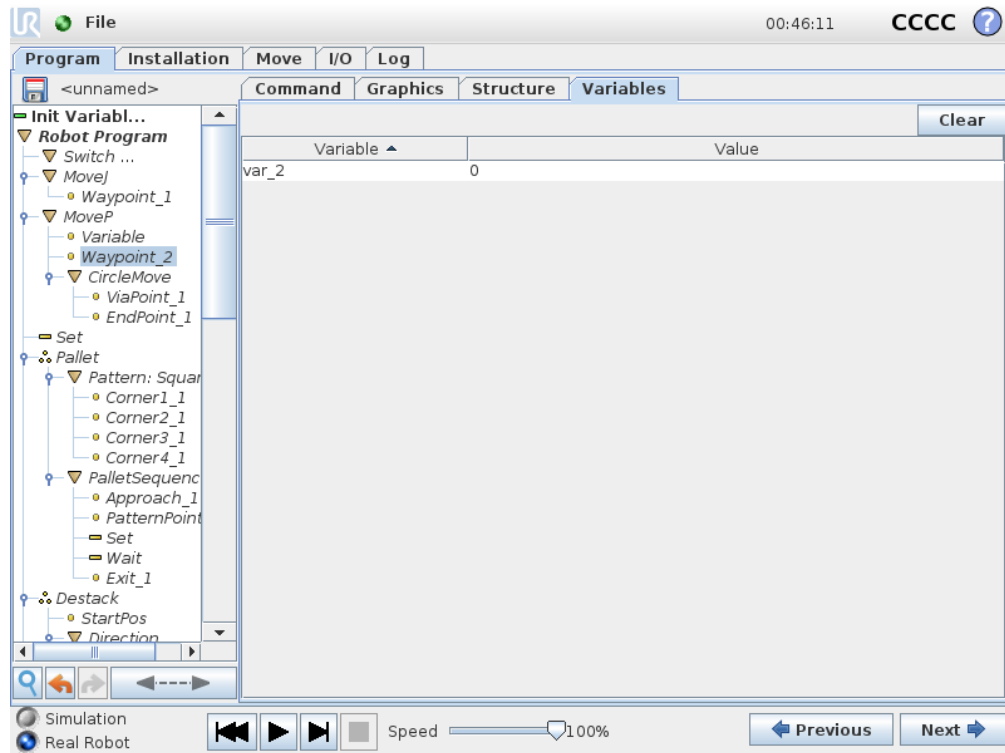

The **Variables** tab shows the live values of variables in the running program, and keeps a list of variables and values between program runs. It only appears when it has information to display. The variables are ordered alphabetically by their names. The variable names on this screen are shown with at most 50 characters, and the values of the variables are shown with at most 500 characters.

14.33 Command: Variables Initialization

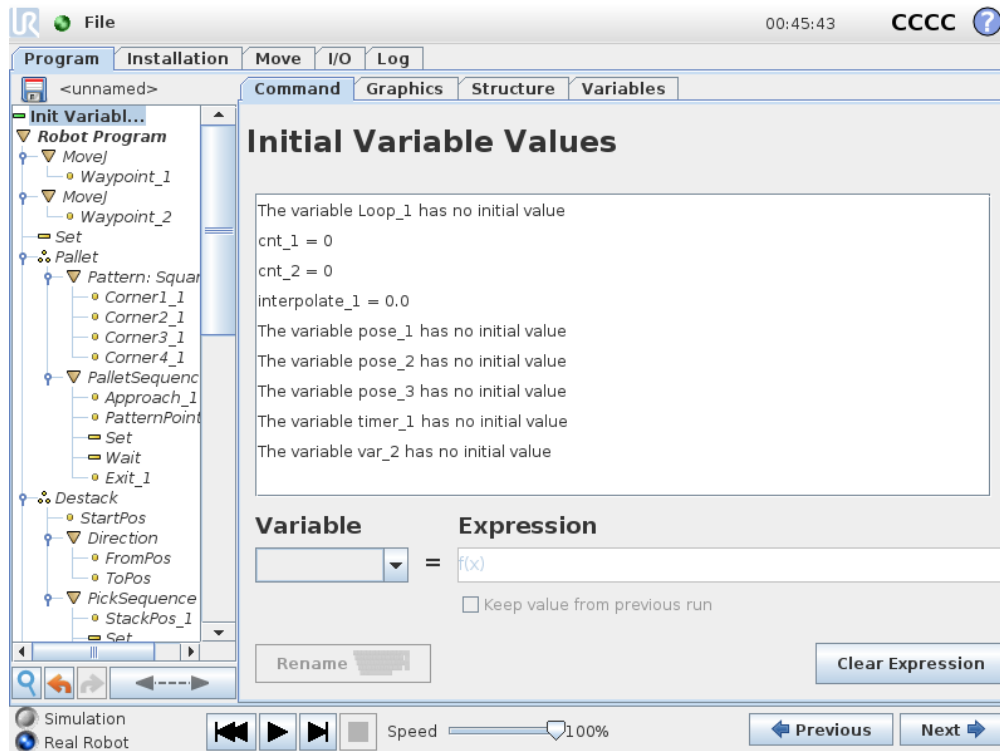

This screen allows setting variable values before the program (and any threads) start executing.

Select a variable from the list of variables by clicking on it, or by using the variable selector box. For a selected variable, an expression can be entered that will be used to set the variable value at program start.

If the **Keep value from previous run** check-box is selected, the variable will be initialized to the value found on the **Variables** tab (see 14.32). This permits variables to maintain their values between program executions. The variable will get its value from the expression if the program is run for the first time, or if the value tab has been cleared.

A variable can be deleted from the program by setting its name to blank (only spaces).

15 Setup Screen

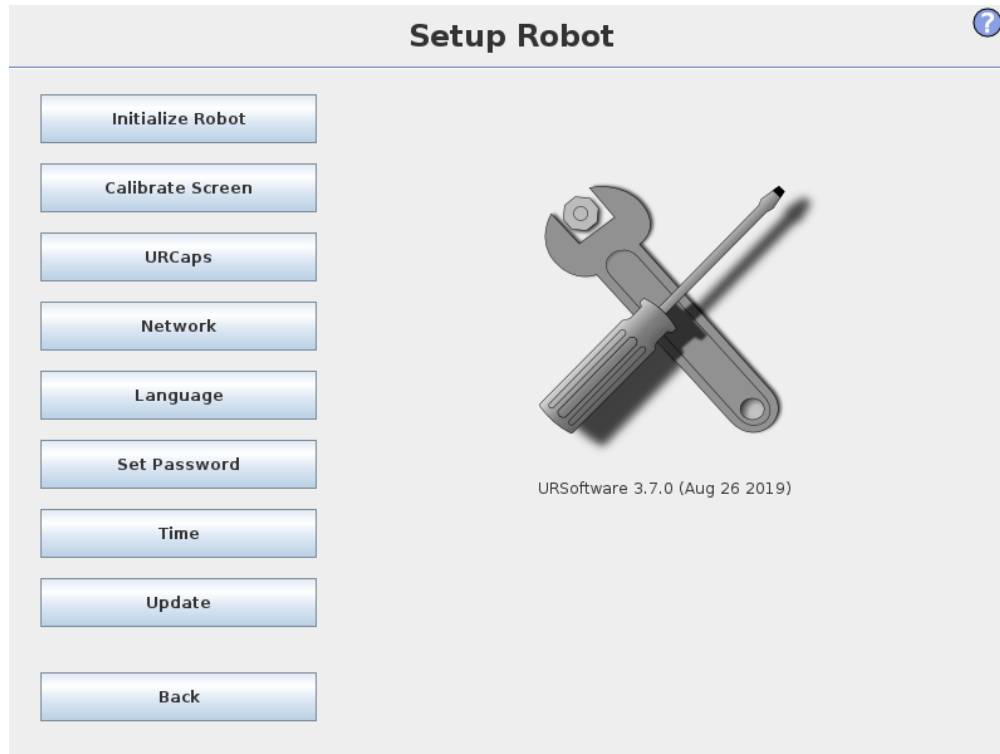

- **Initialize Robot** Goes to the initialization screen, see 11.5.
- **Language and Units** Configure the language and units of measurements for the user interface, see 15.1.
- **Update Robot** Upgrades the robot software to a newer version, see 15.2.
- **Set Password** Provides the facility to lock the programming part of the robot to people without a password, see 15.3.
- **Calibrate Screen** Calibrates the “touch” of the touch screen, see 15.4.
- **Setup Network** Opens the interface for setting up the Ethernet network for the robot control box, see 15.5.
- **Set Time** Set the time and date for the system and configure the display formats for the clock, see 15.6.
- **URCaps Setup** Overview of installed URCaps as well as options for installation and uninstallation, see 15.7.
- **Back** Returns to the Welcome Screen.

15.1 Language and Units

The screenshot shows the 'Setup Robot' interface. On the left is a vertical menu with buttons for 'Initialize Robot', 'Calibrate Screen', 'URCaps', 'Network', 'Language', 'Set Password', 'Time', 'Update', and 'Back'. The 'Language' button is highlighted. The main area is titled 'Setup Robot' and contains two sections: 'Language Selection' and 'Units Selection'. In 'Language Selection', there are dropdown menus for 'System' and 'Keyboard', both set to 'Int'l English', and a checked checkbox for 'English programming'. In 'Units Selection', there are radio buttons for 'Metric units' (selected) and 'U.S. customary'. At the bottom right, there is a 'Restart' button and the text 'Restart PolyScope for new settings to take effect'.

Language, units and keyboard language used in PolyScope can be selected on this screen.

The selected language will be used for the text visible on the various screens of PolyScope as well as in the embedded help. Tick off “English programming” to have the names of commands within robot programs written in English. PolyScope needs to be restarted for changes to take effect.

The selected keyboard language will be used in all pop-up keyboards in PolyScope.

15.2 Update Robot

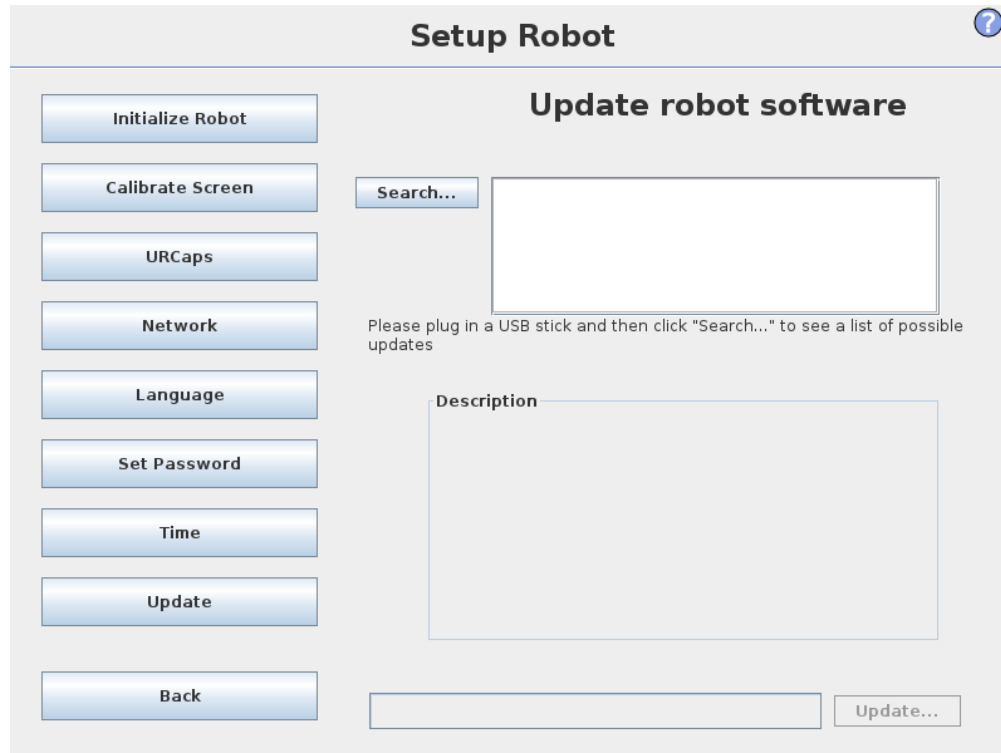

Software updates can be installed from USB flash memory. Insert an USB memory stick and click **Search** to list its contents. To perform an update, select a file, click **Update**, and follow the on-screen instructions.



WARNING:

Always check your programs after a software upgrade. The upgrade might change trajectories in your program. The updated software specifications can be found by pushing the “?” button located at the top right corner of the GUI. Hardware specifications remain the same and can be found in the original manual.

15.3 Set Password

The screenshot shows the 'Setup Robot' interface with a sidebar on the left containing buttons for 'Initialize Robot', 'Calibrate Screen', 'URCaps', 'Network', 'Language', 'Set Password', 'Time', 'Update', and 'Back'. The main area is divided into two sections: 'System Password' and 'Safety Password'. The 'System Password' section has input fields for 'New password' and 'Confirm new password', followed by an 'Apply' button. The 'Safety Password' section has input fields for 'Current password', 'New password', and 'Confirm new password', followed by an 'Apply' button.

Two passwords are supported. The first is an *optional* System password which prevents unauthorized modification of the setup of the robot. When the System password is set, programs can be loaded and executed without the password, but the user must enter the correct password in order to create or change programs.

The second is a *required* Safety password which must be entered correctly in order to modify the safety configuration.



NOTE:

In order to change the safety configuration, the Safety password must be set.



WARNING:

Add a System password to prevent non-authorized personnel from changing the robot installation.

Copyright © 2009–2019 by Universal Robots A/S. All rights reserved.

15.4 Calibrate Screen

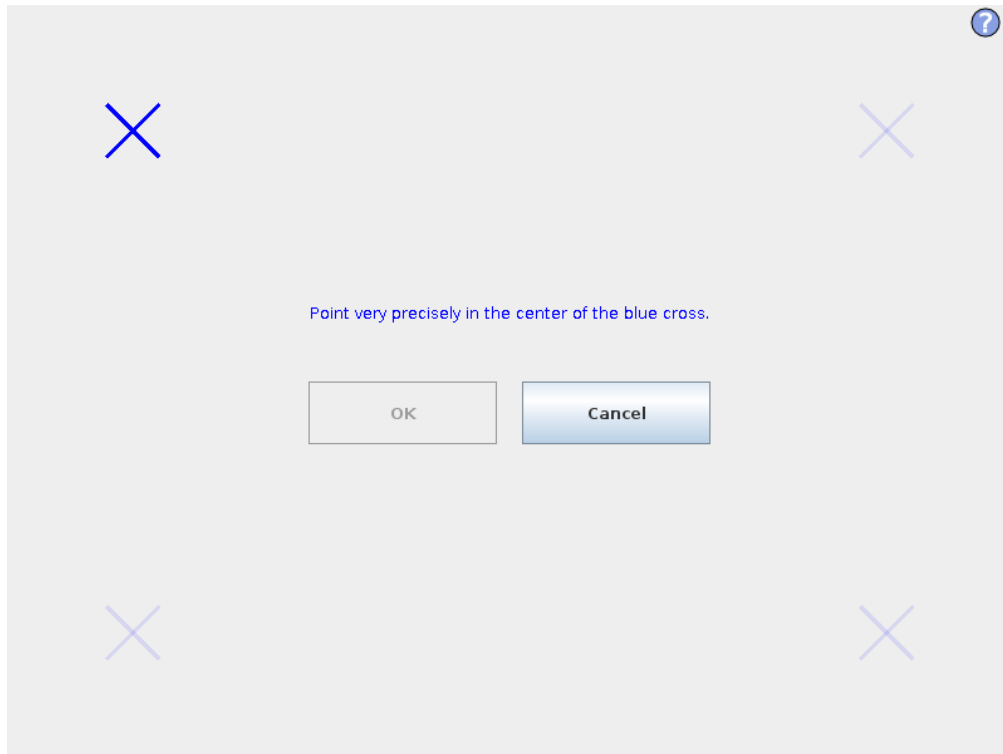

Calibrating the touch screen. Follow the on-screen instructions to calibrate the touch screen. Preferably use a pointed non-metallic object, such as a closed pen. Patience and care help achieve a better result.

15.5 Setup Network

Setup Robot

Network

Select your network method

- DHCP
- Static Address
- Disabled network

✗ Not connected to network!

Network detailed settings:

IP address: 0.0.0.0

Subnet mask: 0.0.0.0

Default gateway: 0.0.0.0

Preferred DNS server: 0.0.0.0

Alternative DNS server: 0.0.0.0

Apply

Panel for setting up the Ethernet network. An Ethernet connection is not necessary for the basic robot functions, and is disabled by default.

15.6 Set Time

?

Setup Robot

Initialize Robot

Calibrate Screen

URCaps

Network

Language

Set Password

Time

Update

Back

Set Time

Time format:

24 Hour
 12 Hour

Please select the current time:

+	+	+
00	:	44
-	-	-

Set Date

Please select today's date:

August 26, 2019

Date format:

August 26, 2019
 Aug 26, 2019
 8/26/19

Restart PolyScope for new settings to take effect

Restart

Set the time and date for the system and configure the display formats for the clock. The clock is displayed at the top of the *Run Program* and *Program Robot* screens. Tapping on it will show the date briefly. The GUI needs to be restarted for changes to take effect.

15.7 URcaps Setup



In the top list an overview of all installed *URcaps* is presented. Clicking on a *URcap* displays its meta information (including the name of the *URcap*, the version, license etc.) in the *URcap Information* area below the list.

Click the + button in the bottom of the screen to install a new *URcap*. A file chooser is shown where a *.urcap* file can be selected. Click *Open* and *PolyScope* will return to the setup screen. The selected *URcap* will be installed and a corresponding entry will appear in the list shortly after. Newly installed or uninstalled *URcaps* require *PolyScope* to be restarted and the *Restart* button will be enabled.

To uninstall a *URcap*, simply select the *URcap* in the list and click the – button. The *URcap* will disappear from the list, but a restart is still required.

In the list, the icon shown next to an entry indicates the state of the *URcap*. The different states are defined below:

- ✔ *URcap ok*: The *URcap* is installed and running normally.
- ⚠ *URcap fault*: The *URcap* is installed but unable to start. Contact the *URcap* developer.
- 🔄 *URcap restart needed*: The *URcap* has just been installed and a restart is required.

Part III

EUROMAP 67 Interface

16 Introduction

This manual is intended for the integrator. It contains important information regarding integration, programming, understanding and debugging.

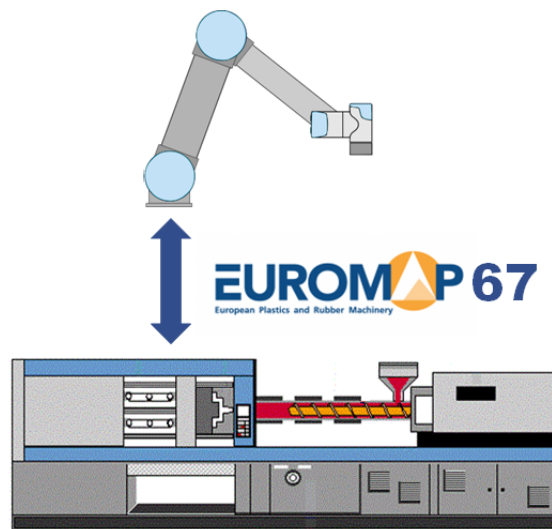

Abbreviations used in this document are explained below.

Abbreviation	Meaning
UR	Universal Robots
CB	Controller Box
IMM	Injection Moulding Machine
MAF	Moulding Area Free
A, B, C, ZA, ZB and ZC	Signals inside EUROMAP 67 cable



NOTE:

EUROMAP 67 is only supported on controller boxes produced after September 2014.

**DANGER:**

An IMM can use up to 250V on some of its signals. Do not connect an IMM to the EUROMAP 67 interface if it is not properly installed in a controller box; including all mandatory ground connections.

**DANGER:**

1. Make sure to install a light curtain (safety device) between the robot and the IMM in such a way that the IMM cannot close the mould when the robot is inside it. Failure to do so may damage both the robot and the mould.
2. Read and understand this manual completely before trying out the euromap 67 interface.

16.1 EUROMAP 67 standard

The EUROMAP 67 standard is free of charge and can be downloaded from www.euromap.org. The UR EUROMAP 67 module conforms to all demands in this standard when it is powered up. When it is powered down the EUROMAP 67 standard specifies that every safety related signal shall be operative. This may cause hazardous situations and contradicts the safety specifications of ISO 13849-1 and EN ISO 13849-1. Therefore, the UR EUROMAP 67 module opens the emergency stop signals, MAF signals and all I/O signals when the controller box is powered off.

All optional, manufacturer dependent and reserved I/O signals are supported. Interfacing according to EUROMAP 67.1 is also possible.

16.2 Statutory notice

The interface is constructed with the same components and principles, and under the same test requirements, as the control box and can only be purchased in conjunction with a control box. The EUROMAP 67 interface therefore falls under the Declaration of Incorporation, found in the Hardware Installation Manual.

**DANGER:**

1. An IMM is an extremely dangerous machine. Read and understand the manual for the IMM. Failure to integrate the robot and IMM in a safe way might cause death, serious injury or damage to the machines. Universal Robots cannot be held responsible for any damage caused by an IMM (E.g. if a robot or person is damaged by movements of the mould).
2. When modifying an IMM a new risk assessment for the IMM shall be conducted. The risk assessment shall consider all new hazards and to also reconsider all existing hazards as they may have increased.
3. The integrator is responsible for complying with all national and regional requirements for IMM. This manual does not summarize any of these requirements.

Copyright © 2009–2019 by Universal Robots A/S. All rights reserved.

17 Robot and IMM integration

The following subsections contain important information for the integrator.

17.1 Emergency stop and safeguard stop

The emergency stop signals are shared between the robot and the IMM. This means that a robot emergency stop also emergency stop the IMM and vice versa.

The safeguard stop signals (Safety devices [ZA3-ZC3] [ZA4-ZC4]) ensure that the robot is safeguard stopped when a door on the IMM is open.



DANGER:

1. It is **not** a part of the EUROMAP 67 standard to stop the IMM if the robot is safeguard stopped. This means that if the operator enters (walks into) the workspace of the robot, he shall not be able to enter (or reach into) the workspace of the IMM (Unless a safety device on the IMM causes a safe stop of the IMM when the operator enters (or reaches into) the workspace of the IMM). If a safety device shall safeguard stop both the robot and the IMM, then connect it to the IMM.
2. If a third machine is connected to the robot through the special “external emergency stop” input on the controller box [EEA-EEB], **only** the robot will emergency stop if an emergency stop button is pushed on the third machine, **not** the IMM!
3. Always verify the functionality of all safety related functions. Look in the manual for both the robot and the IMM regarding safety function requirements.

17.2 Connecting a MAF light guard

The MAF signal [A3-C3] in the EUROMAP 67 cable enables the powerful movement of the mould. Care must be taken to prevent the mould from closing when the robot is inside the machine.

The EUROMAP 67 interface is supplied without a MAF light guard. This means that an error in the robot program could cause the IMM mould to close and crush the robot. However, it is possible to connect a light guard as shown below to prevent these accidents. A Category¹ 1 light curtain can be purchased for a few hundred USD (e.g. “PSEN op 2H-s/1” from Pilz).

¹According to ISO 13849-1, see Glossary for more details.



CAUTION:

If you do not install a light curtain you may damage both the robot and the mould.

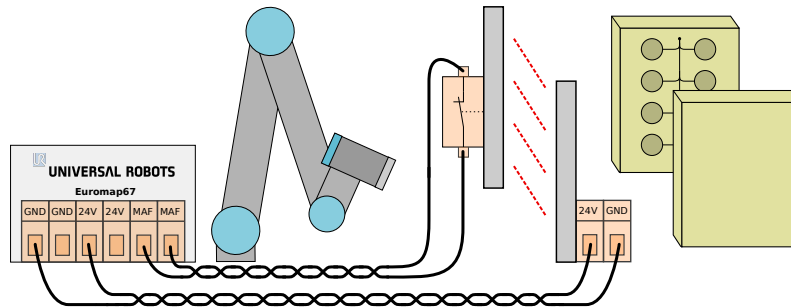

17.3 Mounting the robot and tool

Before constructing a tool and a mounting surface, the integrator must consider how joint 4 (wrist 2) is orientated during pick and place. Joint 1, 2 and 3 has parallel axes and if joint 4 orientates joint 5 to the left or to the right then joint 5 is parallel to the other three axes, which forms a singularity. It is generally a good idea to place the robot in a 45 degree angle or constructing a tool where the surface of the tool flange of the robot points down when gripping the items from the vertical mould surface.

17.4 Using the robot without an IMM

To operate the robot without an IMM, a by-pass plug must be used to close the emergency and safety signals. The only alternative is to permanently uninstall the interface as described in 19.1.



DANGER:

Never use the by-pass plug when the robot is installed together with an IMM.

17.5 EUROMAP 12 to EUROMAP 67 conversion

To interface an IMM with EUROMAP 12 interface an E12 - E67 adaptor must be used. Several adaptors is available on the marked from different manufacturers. Unfortunately most adaptors are constructed for specific robots or IMM's assuming specific designs choices. This means that some adaptors will **not** connect the UR robot and your IMM correctly. It is recommended to read both the EUROMAP 12 and EUROMAP 67 standard whenever using or constructing an adaptor.

A list with common errors is shown below:

17.5 EUROMAP 12 to EUROMAP 67 conversion

1. Do you measure 24V between A9 and C9?
 - The IMM must supply 24V to enable the I/O signals.
 - If the robot and the IMM has common minus/0V then the robot 24V can be used by connecting A9 to ZA9 and C9 to ZC9. IMM 24V is often present at EUROMAP 12 pin 32.
2. Is the adaptor switching **both** robot emergency channels and **both** robot safety devices channels?
 - This is typically accomplished using 4 relays.



DANGER:

Make sure the E12 - E67 converter conforms to the EUROMAP 67 and EUROMAP 12 standards and that the safety functions are constructed with the correct performance level. Failure to follow this warning could result in serious injury or death as the safety function could be overridden.

Copyright © 2009–2019 by Universal Robots A/S. All rights reserved.

18 GUI

The next subsections describe how the euomap interface is controlled from the GUI, how to verify the signals to and from the IMM, how the easy programming is done with structures and how more advanced things can be accomplished using the signals directly.

It is, though, highly recommended to use the EUROMAP 67 program template instead of making a program from scratch, see below.

18.1 EUROMAP 67 program template

After installing the EUROMAP 67 interface, an extra button appears which gives access to the EUROMAP 67 program template.

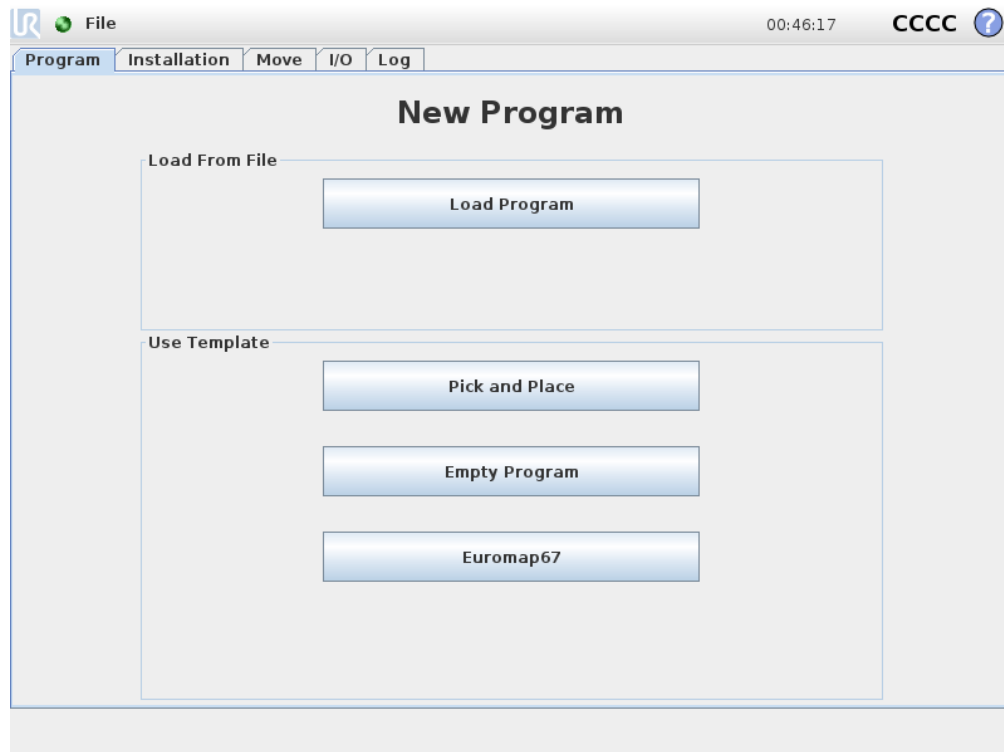

Selecting the EUROMAP 67 program template, the program screen will appear with the template loaded. The template structure will then be visible on the left side of the screen.

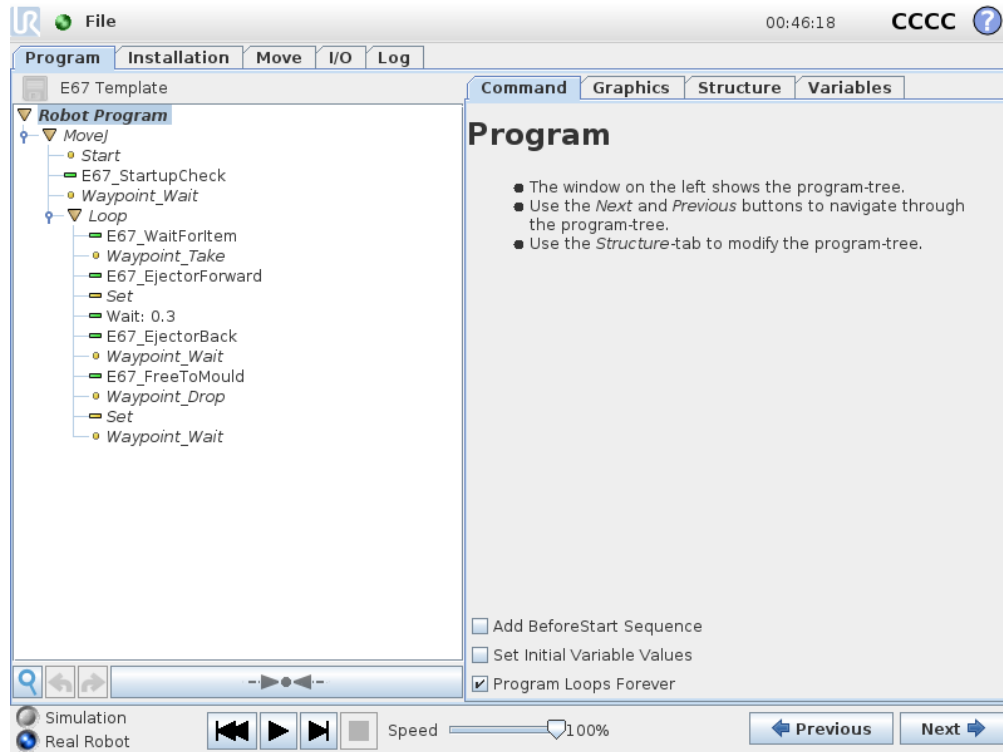

The EUROMAP 67 program template is prepared for performing simple interaction with an IMM. By specifying only a few waypoints, and a pair of I/O actions, the robot is ready for handling the objects made by the IMM. The waypoints are:

- **WP.home.position:** The robot starting point for the procedure.
- **WP.wait.for.item:** The waypoint where the robot will be placed while waiting for an item to be ready from the IMM.
- **WP.take.item:** The waypoint where the robot will take the item from (inside) the IMM.
- **WP.drop.item:** The waypoint where the robot will drop the item just fetched from the IMM.

The two *Action* nodes are intended for controlling a tool capable of grabbing and holding the items from the IMM, and then releasing and dropping them when moved outside the IMM.

Now, the procedure will cycle through the steps, continuously removing newly constructed items from the IMM. Obviously, the *Loop* node should be customized such that the robot will only run this cycle as long as there are items to take. Also, by customizing the *MoveJ* node, the robot movement speed should be adjusted to fit the IMM cycle time, and, if necessary, the level of fragility of the items. Finally, each EUROMAP 67 structure is customizable to suit the specific IMM procedure.

18.2 I/O overview and troubleshooting

The EUROMAP 67 I/O overview is found under the I/O tab.

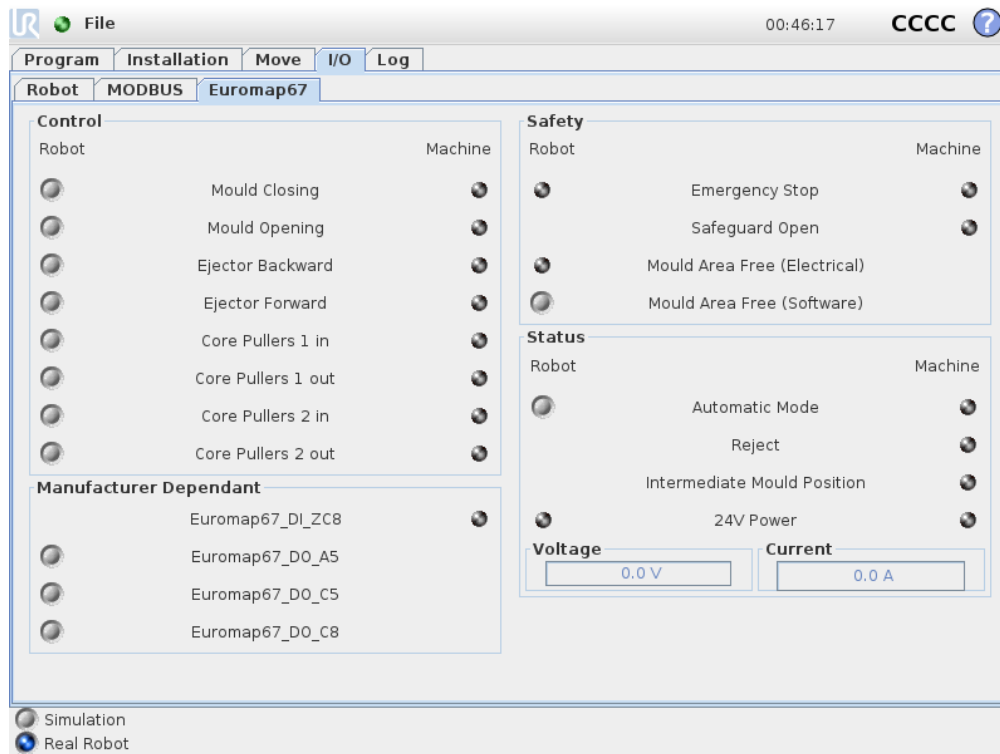

There are four frames on this screen, which are described separately below. Common for all are the two columns *Robot* and *Machine*, which respectively shows buttons for controlling output signals, and indicators for showing state of input signals.

The (normal) state of the signals at startup, is that they are all low, except for the 24V signals, and the robot output *Automatic Mode* which is active-low and therefore set high per default.

If a signal is not part of a program structure, and it is intended to be used in a robot program, this is achievable making use of e.g. *Action* and *Wait* nodes.

**NOTE:**

“Automatic mode” from the robot to the IMM is active low. The button reflects the physical level and therefore “Automatic mode” is **activated** when the button is **not** activated.

**NOTE:**

The buttons for controlling output signals are per default only available in robot programming mode. This can, however, be set as desired on the *I/O setup* tab found on the *Installation* screen.

18.2.1 Control

The signals related to controlling the interaction between the robot and the IMM are shown here. These signals are all used by the program structures, where they have been joined in appropriate

and secure ways.

18.2.2 Manufacturer dependent

These are signals, that may have specific purposes according to the IMM manufacturer. The robot is not dependant on specifics of these signals, and they can be used as needed.

18.2.3 Safety

In the robot column, the indicators *Emergency Stop* and *Mould Area Free (Electrical)* are not controllable from this screen. They simply indicate if the robot is emergency stopped, and if the MAF output is set high. The MAF output is set high under the condition that the electrical supervision signal of the mould area (possible with use of light guard, as explained above), and the MAF signal from the software are both high. The MAF signal from software can be controlled by the respective button. The emergency stop signal from the machine indicates whether the IMM is emergency stopped. The *Safeguard Open* input shows the state of the "Safety devices" signals specified in the EUROMAP 67 standard.

18.2.4 Status

The operation mode of the robot and the IMM can be controlled/viewed (these signals are also used in the program structures). The bars showing voltage and current consumption represent the values delivered to the IMM and possibly a light guard by the EUROMAP 67 module.

18.3 Program structure functionality

There are seven program structures, which can be selected from the *Structure* tab on the program screen. These structures will be available after the europa67 interface has been properly installed (as explained in 19). An example of their use, can be seen in the EUROMAP 67 program template.

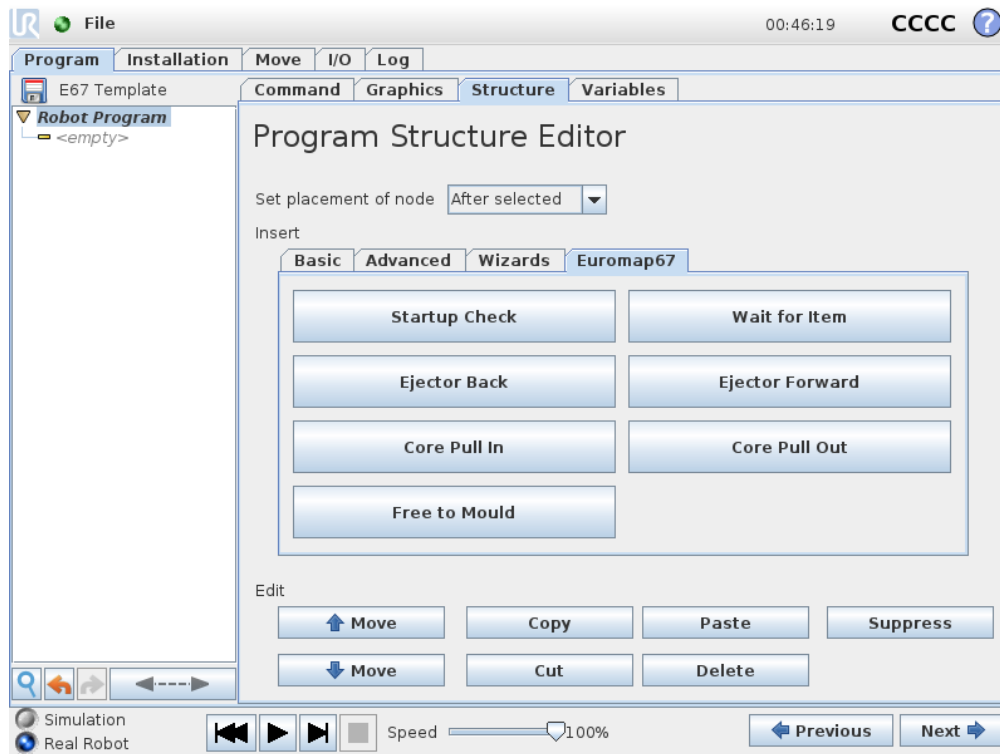

The structures are all made to achieve a proper and safe interaction with the IMM, and therefore they all include tests that certain signals are set correctly. Also, they may set more than one output to enable only one action.

When a program structure is inserted into a robot program, it can be customized by selecting the structure in the program, and then clicking on the *Command* tab. All program structures consist of a number of steps. Most of the steps are enabled per default, and some cannot be disabled because they are essential to the structure intention. The *Test* steps make the program stop if the test condition is not met. Both the state of inputs and outputs are testable. *Set output* steps set a specified output to either high or low. *Wait until* steps are typically used for waiting until a movement has been finished before continuing with further steps and following program nodes.

18.3.1 Startup Check

Intended for use once in the beginning of a robot program, to make sure the robot and machine are set up correctly before moulding is started. Use the checkboxes to enable/disable individual steps.

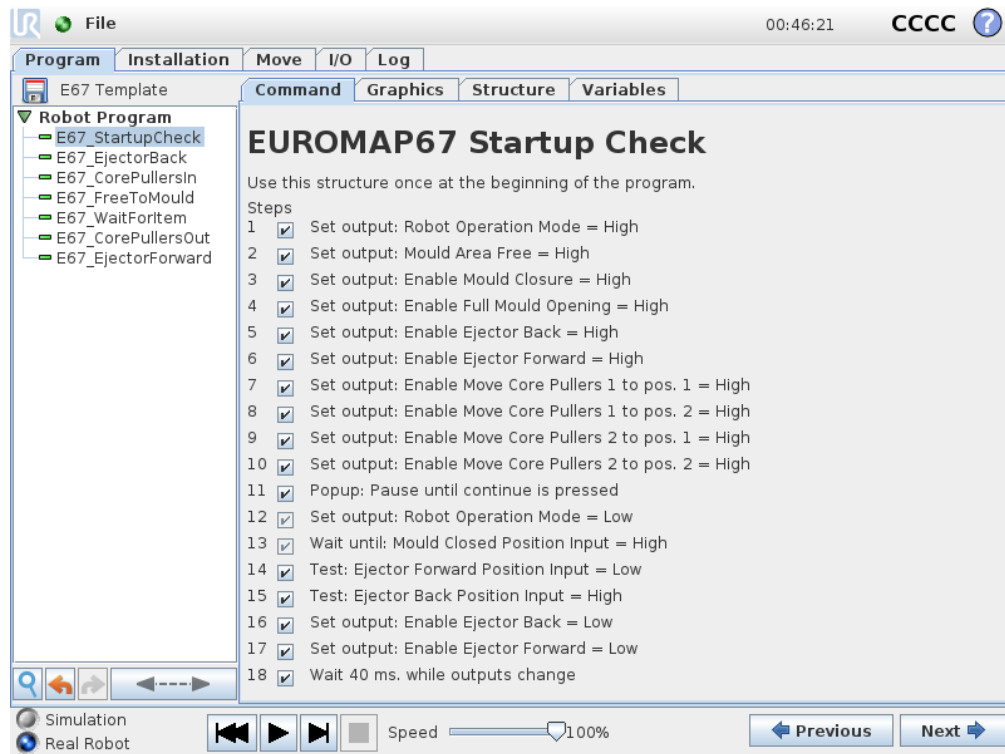

18.3.2 Free to Mould

Used for signalling the IMM that it is allowed to start a moulding operation. When this signal is activated, the robot **must** be placed outside the IMM. Use the checkboxes to enable/disable individual steps.

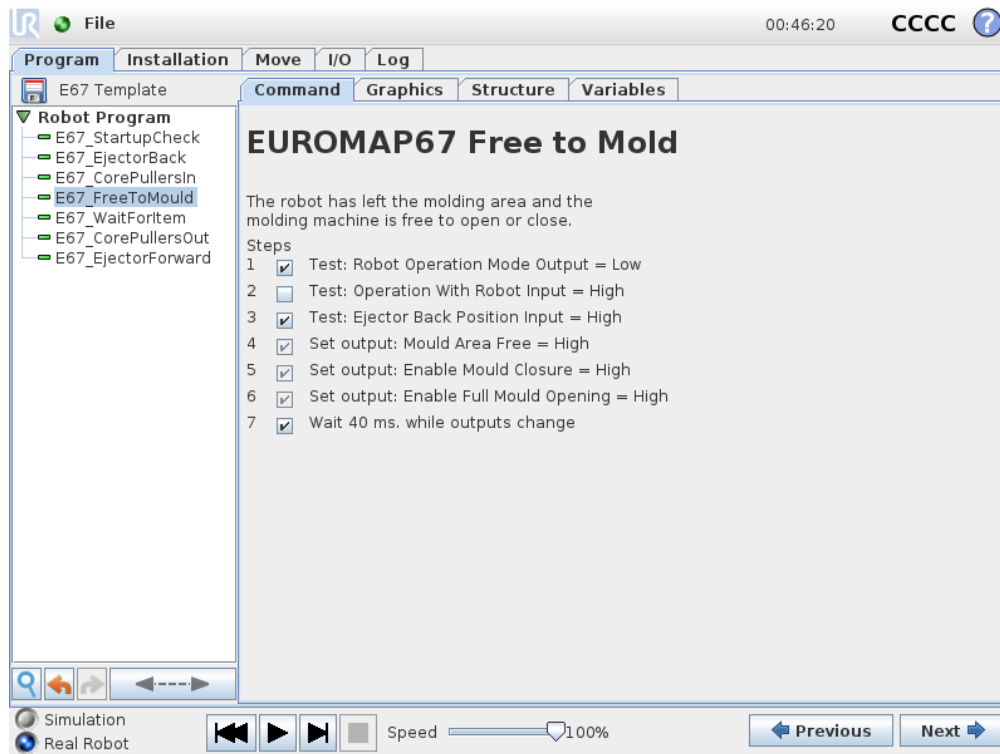
**CAUTION:**

When this signal is activated, the robot shall be outside the mould, so that the mould can close without touching the robot.

18.3.3 Wait for Item

Intended for making the robot wait until an item is ready from the IMM. Use the checkboxes to enable/disable individual steps.

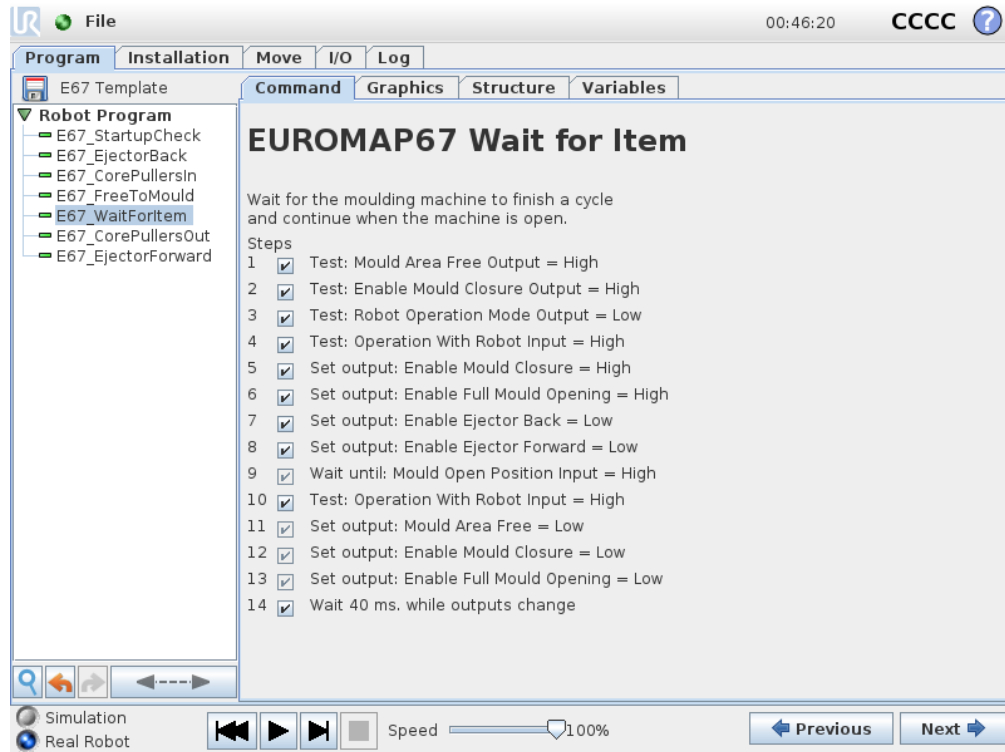

18.3.4 Ejector Forward

Enables the movement of the ejector which removes an item from the mould. Should be used when the robot is in position ready for grasping the item. Use the checkboxes to enable/disable individual steps.

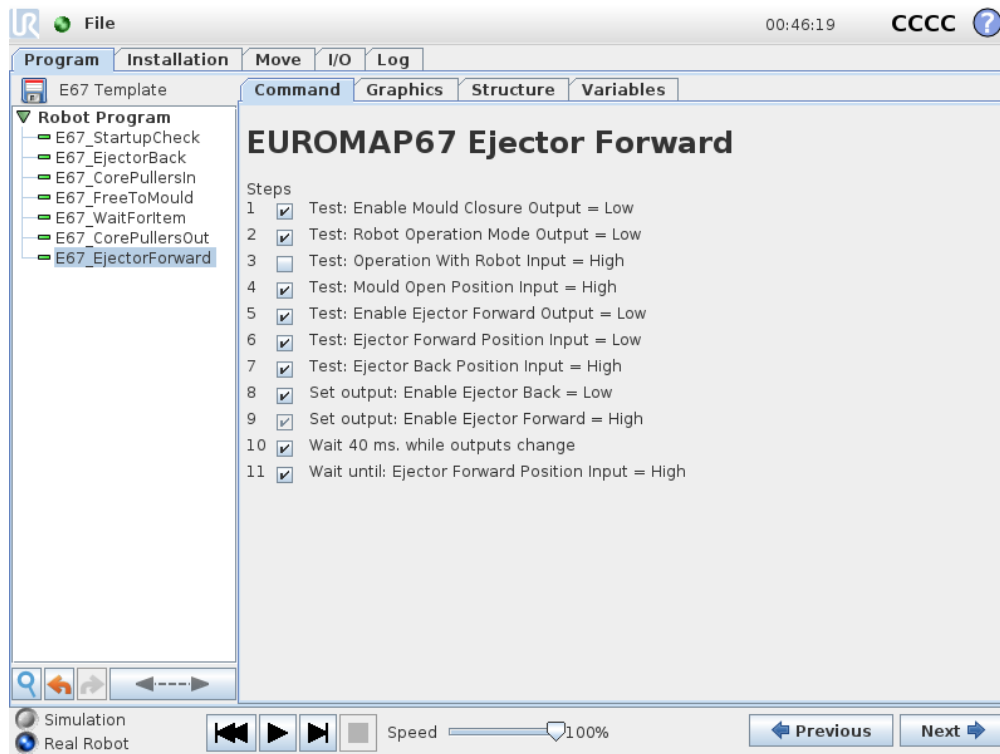

18.3.5 Ejector Back

Enables the movement of the ejector to its back position. Use the checkboxes to enable/disable individual steps.

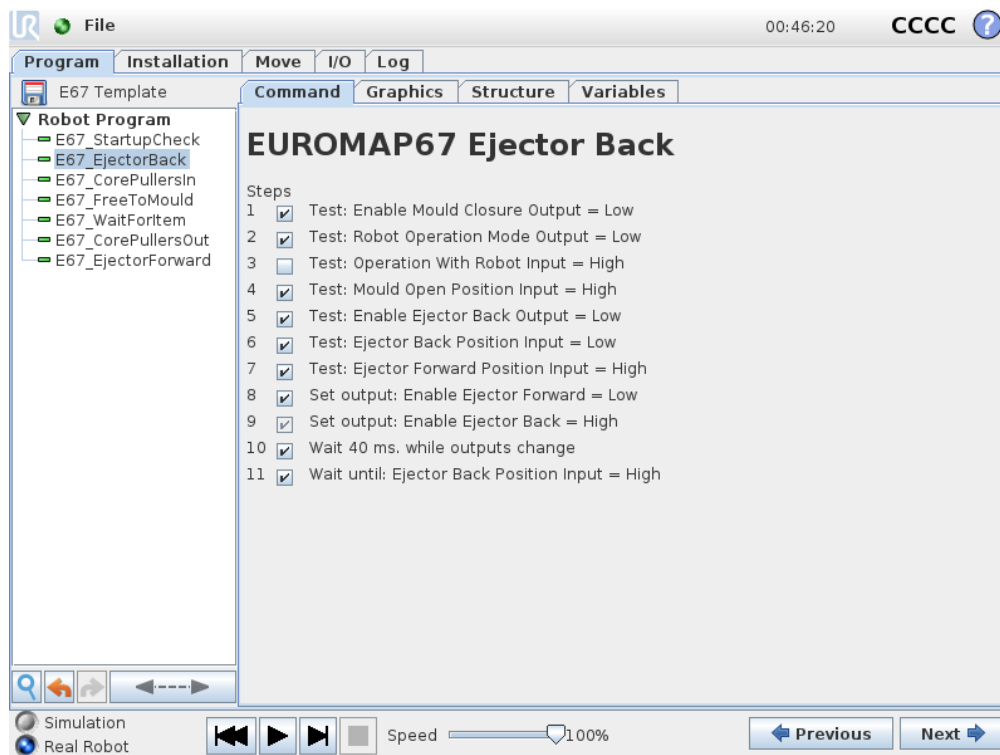

Copyright © 2009–2019 by Universal Robots A/S. All rights reserved.

18.3.6 Core Pullers In

Enables the movement of the core pullers to position 1. Which core pullers are used is selected from the drop down menu. Use the checkboxes to enable/disable individual steps.

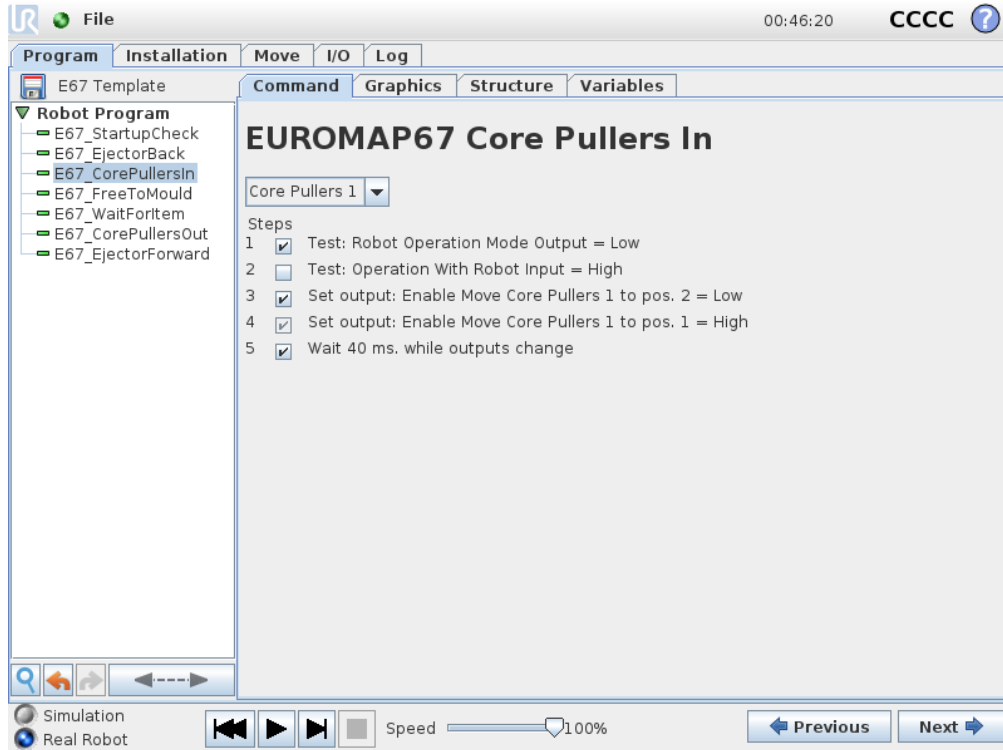

18.3.7 Core Pullers Out

Enables the movement of the core pullers to position 2. Which core pullers are used is selected from the drop down menu. Use the checkboxes to enable/disable individual steps.

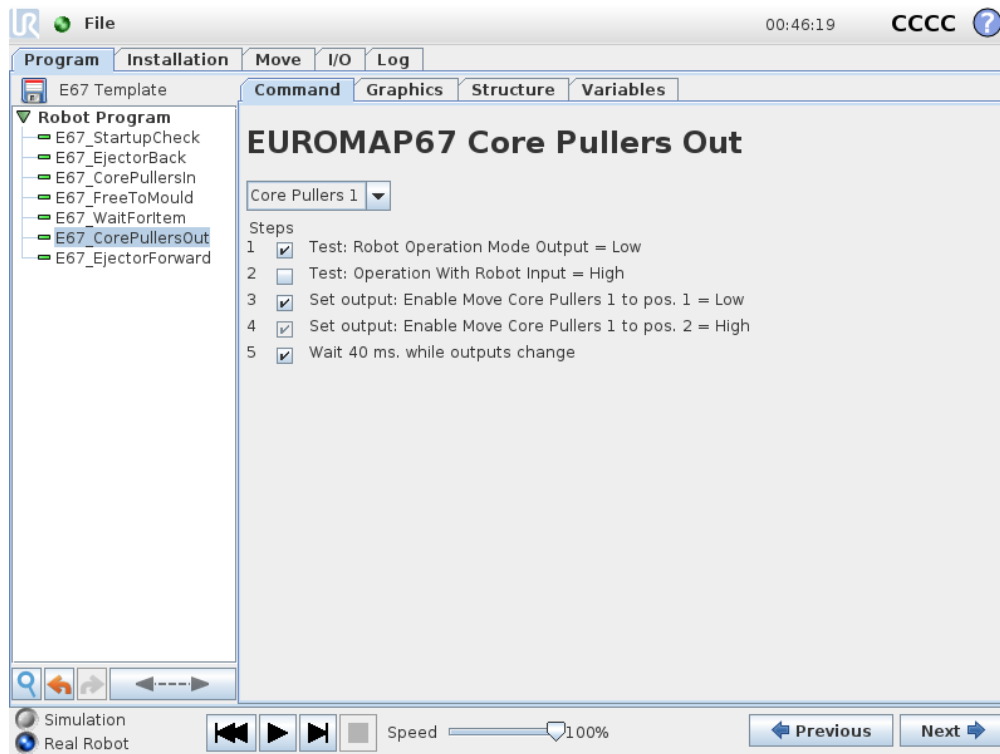

18.4 I/O action and wait

As the robot digital outputs can be set by an *Action* node, so can also the EUROMAP 67 output signals. When the EUROMAP 67 interface is installed, the signals appear in the menus where they can be selected. Also, as the robot digital inputs, EUROMAP 67 input signals can be used to control the program behavior by inserting a *Wait* node, which makes the program wait until an input is either high or low.

For advanced users, an output can be set to the value of a specified expression. Such expression may contain both inputs, outputs, variables, etc., and can be used to obtain complex program functionality. Likewise, a *Wait* node can be set to wait until the value of an expression is true. Generally, the EUROMAP 67 signals will all be available on the expression screen, which means that they can be used in all circumstances where an expression can be selected.

In order to use signals, which are not part of the EUROMAP 67 program structures, they must be either set or read “manually” from a program, by inserting additional *Action*, *Wait*, etc. nodes. This applies to e.g. the manufacturer dependent and the reserved signals, which are all usable although not shown on the EUROMAP 67 I/O tab. This also means that in order to make use of the inputs *Reject* and *Intermediate Mould Opening Position*, the template program will have to be customized and extended.

Finally, it is recommended to NOT set the *Mould Area Free* signal manually, as this may cause hazardous situations.

Copyright © 2009–2019 by Universal Robots A/S. All rights reserved.

19 Installing and uninstalling the interface

To achieve redundancy of the safety functionality, the controller box knows whether it shall expect a EUROMAP 67 interface to be present or not. Therefore, the installing and uninstalling procedures below must be followed precisely.

Please note the orientation of the ribbon cable below.



CAUTION:

1. Do **not** plug/unplug the ribbon cable when the controller box is powered on.
2. The ground (earth) connection shall be screwed on when plugging/unplugging the ribbon cable.
3. Never power on the control box without the ground (earth) connection.

19.1 Installing

The interface can be placed at the bottom or in the left side of the controller box, see pictures below and follow the procedure. It is not allowed to install the interface in any other way.

1. Power down the controller box.
 - The green light of the power button of the teach pendant must be off.
2. Mount the interface.
 - Use 1 M6 nut to screw on the ground connector.
 - Use 4 M4×8mm screws to screw on the interface.
 - Use 4 M4×8mm screws to cover the empty holes.

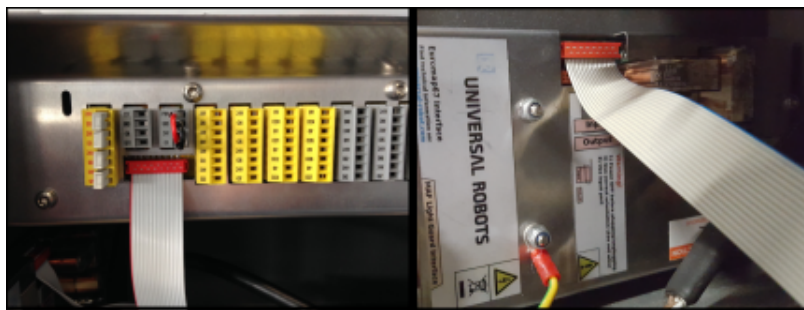

Figure 19.1: Ribbon cable connection

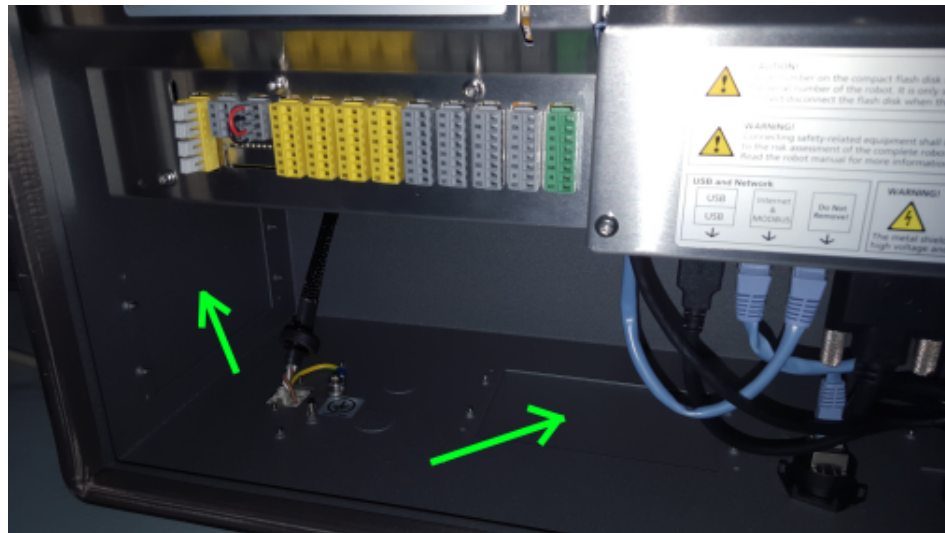

Figure 19.2: Interface placements in the controller box

- Click on the ribbon cable with the right orientation.
 - Use some fixing pads to fix the ribbon cable.
3. Power up the controller box.
 - The interface is automatically detected.
 - The safety system of the robot reports that EUROMAP 67 is detected but not defined in the robot Installation. Go to Installation, Safety, and Miscellaneous and check the check-box *Euromap67*.
 - Press the button *Save and restart*.
 - The GUI restarts.
 - Confirm the new safety settings.
 - The EUROMAP 67 is now installed and ready to use.

19.2 Uninstalling

Follow the procedure below.

1. Power down the controller box.
 - The green light of the power button of the teach pendant must be off.
2. Unmount the interface.
 - Remove the ribbon cable.
 - Remove the M6 nut from the ground connector.
 - Remove all M4 screws from the outer side of the controller box.
3. Power up the controller box.

19.2 Uninstalling

- The safety system of the robot reports that EUROMAP 67 is defined in the robot Installation but not detected in the system. Go to Installation, Safety and Miscellaneous and un-check the check-box *Euromap67*.
- Press the button *Save and restart*.
- The GUI restarts.
- Confirm the new safety settings.
- The EUROMAP 67 is now uninstalled.

Copyright © 2009–2019 by Universal Robots A/S. All rights reserved.

20 Electrical characteristics

The following subsections contain useful information for machine builders and debuggers.

20.1 MAF light guard interface

The 24V is shared with the 24V [ZA9–ZC9] in the EUROMAP 67 cable. However, the input signals to the controller box are low current types and therefore most of the current is available. It is recommended to keep the load under 1.2A. The 24V current and voltage is shown on the EUROMAP 67 I/O tab.

The two MAF signals must connect to potential free switch contacts. The MAF signals are 0V/0mA when the “Moulding Area Free (Software)” bit is off.

Parameter	Min	Typ	Max	Unit
24V Voltage tolerance	-15%	-	+20%	-
Current available from 24V supply	-	-	2.0*	A
Overload protection	-	2.2	-	A
[MAF–MAF] Voltage when disconnected	0	12	12.5	V
[MAF–MAF] Current when connected	0	57	70	mA
[MAF–MAF] Protection against wrong connection	-	400	-	mA
[MAF–MAF] Protection against wrong connection	-18	-	30	V



NOTE:

The “MAF light guard interface” signals are not galvanically isolated from the shield of the controller box.

20.2 Emergency stop, safety devices and MAF signals

The signals signalling emergency stop and MAF to the IMM are controlled by force guided safety relays conforming to EN 50205. The switch contacts are galvanically isolated from all other signals and conforms to IEC 60664-1 and EN 60664-1, pollution degree 2, overvoltage category III.

The signals signalling emergency stop and safeguard stop (safety devices) to the robot are connected to the potential of the controller box.

Parameter	Min	Typ	Max	Unit
[C1-C2] [C3-C4] Voltage	10.2	12	12.5	V
[C1-C2] [C3-C4] Current (Each output)	-	-	120	mA
[C1-C2] [C3-C4] Current protection	-	400	-	mA
[A1-A2] [A3-A4] Input voltage	-30	-	30	V
[A1-A2] [A3-A4] Guaranteed OFF if	-30	-	7	V
[A1-A2] [A3-A4] Guaranteed ON if	10	-	30	V
[A1-A2] [A3-A4] Guaranteed OFF if	0	-	3	mA
[A1-A2] [A3-A4] ON Current (10-30V)	7	-	14	mA
[A1-C1] [A2-C2] [A3-C3] Current AC/DC	0.01	-	6	A
[A1-C1] [A2-C2] [A3-C3] Voltage DC	5	-	50	V
[A1-C1] [A2-C2] [A3-C3] Voltage AC	5	-	250	V

20.3 Digital Inputs

The digital inputs are implemented as pnp and are galvanically connected to the controller box. The inputs are compliant with all three types of digital inputs defined in IEC 61131-2 and EN 61131-2, which means that they will work together with all types of digital outputs defined in the same standards.

Parameter	Min	Typ	Max	Unit
Input voltage	-30	24	30	V
Input guaranteed OFF if	-30	-	7	V
Input guaranteed ON if	10	-	30	V
Guaranteed OFF if	0	-	5	mA
ON Current (10-30V)	6	-	10	mA

20.4 Digital Outputs

The digital outputs are implemented as pnp and are galvanically connected to the IMM. The galvanic isolation between the IMM and robot potentials conforms to IEC 60664-1 and EN 60664-1, pollution degree 2, overvoltage Category II. The outputs are constructed in compliance with all three types of digital inputs defined in IEC 61131-2 and EN 61131-2, and with all requirements for digital outputs of the same standards.

The digital outputs use some mA from the 24V of the IMM to control and bias the transistors forming solid-state relays.

Parameter	Min	Typ	Max	Unit
Source current per output	0	-	120	mA
Voltage drop when ON	0	0.1	1	V
Leakage current when OFF	0	0	0.1	mA
Current used from IMM 24V	-	12	25	mA

Glossary

Stop Category 0: Robot motion is stopped by immediate removal of power to the robot. It is an uncontrolled stop, where the robot can deviate from the programmed path as each joint brake as fast as possible. This protective stop is used if a safety-related limit is exceeded or in case of a fault in the safety-related parts of the control system. For more information, see ISO 13850 or IEC 60204-1.

Stop Category 1: Robot motion is stopped with power available to the robot to achieve the stop and then removal of power when the stop is achieved. It is a controlled stop, where the robot will continue along the programmed path. Power is removed as soon as the robot stands still. For more information, see ISO 13850 or IEC 60204-1.

Stop Category 2: A controlled stop with power left available to the robot. The safety-related control system monitors that the robot stays at the stop position. For more information, see IEC 60204-1.

Category 3: The term *Category* should not be confused with the term *Stop Category*. *Category* refers to the type of architecture used as basis for a certain *Performance Level*. A significant property of a *Category 3* architecture is that a single fault cannot lead to loss of the safety function. For more information, see ISO 13849-1.

Performance Level: A Performance Level (PL) is a discrete level used to specify the ability of safety-related parts of control systems to perform a safety functions under foreseeable conditions. PLd is the second highest reliability classification, meaning that the safety function is extremely reliable. For more information, see ISO 13849-1.

Diagnostic coverage (DC): is a measure of the effectiveness of the diagnostics implemented to achieve the rated performance level. For more information, see ISO 13849-1.

MTTFd: The Mean time to dangerous failure (MTTFd) is a value based on calculations and tests used to achieve the rated performance level. For more information, see ISO 13849-1.

Integrator: The integrator is the entity that designs the final robot installation. The integrator is responsible for making the final risk assessment and must ensure that the final installation complies with local laws and regulations.

Risk assessment: A risk assessment is the overall process of identifying all risks and reducing them to an appropriate level. A risk assessment should be documented. Consult ISO 12100 for further information.

Collaborative robot application: The term *collaborative* refers to collaboration between operator and robot in a robot application. See precise definitions and descriptions in ISO 10218-1 and ISO 10218-2.

Safety configuration: Safety-related functions and interfaces are configurable through safety configuration parameters. These are defined through the software interface, see part II.

Copyright © 2009–2019 by Universal Robots A/S. All rights reserved.

Index

- A**
- add Action II-86
 - AfterEnd II-109
 - Anchor Position II-108
- B**
- Base II-25, II-76
 - Base feature II-54
 - BeforeStart II-108
 - Blend parameters II-78
 - Blending II-77
 - Box pattern II-103, II-104
- C**
- Configurable I/O I-31
 - Control Box xi, II-113
 - control box .. I-29, I-31, I-46, I-69, II-30, II-39, II-49, II-64
 - Conveyor Tracking II-113
 - Conveyor Tracking Setup II-60
- D**
- Direction Vector II-85
- E**
- Ethernet I-45
 - EtherNet/IP II-48
 - Expression Editor II-101
- F**
- Feature II-54, II-60
 - Feature menu II-106
 - Folder II-92
 - Force mode II-104
 - Frame II-106
 - Freedrive II-46, II-54, II-107
- G**
- General purpose I/O I-31
- I**
- I/O I-29, I-31, I-33, II-29, II-39, II-48, II-49
 - Installation II-50, II-113
 - Installation variables II-49
 - integrator I-8
- J**
- Joint load II-64
 - joint space II-74
- L**
- Line pattern II-103, II-104
 - List (pattern) II-103
- M**
- MODBUS II-40, II-51, II-52, II-60
 - Motion II-106
 - Mounting bracket xi
 - Move II-29, II-55, II-56, II-74, II-75, II-77, II-88, II-108
 - MoveJ II-74
 - MoveL II-55, II-74
 - MoveP II-55, II-74
- N**
- Normal mode II-114
- P**
- Pallet Sequence II-108
 - Pattern II-103, II-104
 - Point II-106
 - PolyScope xi, II-25, II-27, II-29, II-93
 - popup II-89
 - Pose Editor II-55
 - Program II-29
 - Program Tree II-70, II-71
- R**
- Recovery mode II-32
 - Relative waypoint II-75

risk assessment xii, I-3, I-8, I-10
 Robot arm I-29, I-69, II-49, II-64, II-104, II-106,
 II-110, II-111

S

Safety Configuration I-9
 Safety I/O I-31, I-33
 Safety instructions I-49
 Safety Settings I-3
 Script manual xii
 Service manual xii
 Set II-88
 Simple II-106
 Square pattern II-103, II-104
 standard I-69, I-70, I-72
 Structure II-113
 Switch Case construction II-101

T

Teach Pendant xi, II-107
 Test button II-107
 Tool Center Point II-43, II-76
 Tool feature II-54

Tool I/O I-41

U

Until II-85
 Until Distance II-86
 Until Expression II-86
 UR+ xii

V

Variable feature II-76
 Variable waypoint II-76
 Variables II-73, II-116
 Voltage II-40

W

Wait II-87
 Warning signs I-4
 Warranty I-55
 Waypoint II-74, II-75, II-77, II-83, II-108, II-114
 Waypoints II-27
 Wizards II-113
 Wrist 3 II-25

Software version: 3.11

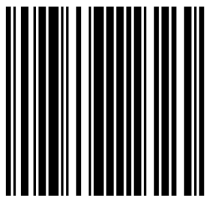

99337