

# Automatic continuous desalting valve

For steam boilers Model 560 - A



EN ASME/ANSI



The conductivity electrode EC-1, the desalting controller RD-1 and the continuous desalting valve with servomotor allow the automatic desalting process of boiler water which eliminates:

- Organic matter and mineral salts in solution. (Calcium, magnesium, sodium, potassium, iron, bicarbonate ions, chlorides, sulphates, nitrates, ...etc.).
- Solid materials in suspension. (Sand, clay, metal residues, rock residues, organic matter, ...etc.).

The continuous bleeding process prevents:

- Damage caused by erosion and perforation, entailing the following high costs:
  - Direct: Replacement or repair of materials.
  - Indirect: Stoppages, product losses, ...etc.
- Danger of boiler explosion.

and reduces:

- Incrustations and sediments caused by precipitation of calcium and magnesium salts, which obstruct thermic transmission and which cause unnecessary and excessive fuel consumption.
- Foam formation caused by excessive saline concentration, with its corresponding drag. This combination of measuring comparison and control ensures minimum water loss and thus gives considerable energy savings.

Conforms to the low voltage directive 73/23/CE version 93/68/CE.

According to the electromagnetic compatibility directive 89/336/CE version 93/68/CE.

## Specifications

— The unit consists of a Continuous desalting valve with servomotor, a Conductivity electrode EC-1 and Desalting controller RD-1 with or without assembly cupboard.

### **A** Continuous desalting valve with servomotor

- 1 Faucet for taking samples: Makes process of analysing the salt concentration of boiler water easier. Possibility of guided connection for pipes with a  $\varnothing$  of 6/8 mm.
- 2 Reader plate: Allows bleeding positions to be seen clearly and concisely, even from some distance away.
- 3 Plug for draining the measuring nozzle.
- 4 Measuring nozzle: Acts as a valve, measuring and control organ. The water under pressure expands silently and gradually into it. Thus, dirt, incrustations and salt deposits are removed. Due to this gradual expansion, the system does not suffer erosion.
- 5 Servomotor mounted on the valve on an angle mounting. A synchronised reversible motor is used as a transmission element. Via gearing it adjusts the position of the regulation lever.

PIECE N°.	PIECE	MATERIAL			
		1	2	3	4
1	Body	Cast steel (EN-1.0619)			
2	Gland body	Nodular iron (EN-5.3106)			
3	Control lever	Cast iron (EN-5.1300)			
4	Flywheel	Aluminium (EN-AC-44200)			
5	Sample-taking faucet body	Stainless steel (EN-1.4008)			
6	Reader plate	Aluminium			
7	Lever lock	Carbon steel (EN-1.1141)			
8	Measuring nozzle seating	Stainless steel (EN-1.4028)			
9, 10	Measuring nozzle cap	Stainless steel (EN-1.4028)			
11	Measuring nozzle endless nut	Stainless steel (EN-1.4028)			
12, 17	Gland	Carbon steel (EN-1.1191)			
13	Measuring nozzle shaft	Stainless steel (EN-1.4028)			
14	Sample-taking faucet gland body	Carbon steel (EN-1.1191)			
15	Sample-taking faucet gland washer	Stainless steel (EN-1.4401)			
16	Gland nut	Carbon steel (EN-1.1191)			
18	Sample-taking faucet shaft	Stainless steel (EN-1.4401)			
19	Seal	Stainless steel (EN-1.4401)			
20	Sample-taking faucet connection nut	Carbon steel (EN-1.1191)			
21	Sample-taking faucet connection	Carbon steel (EN-1.1191)			
22	Adapter	Carbon steel (EN-1.0308)			
23	Adapter nut	Carbon steel (EN-1.0308)			
24	Cutting ring	Carbon steel (EN-1.0308)			
25	Draining plug	Carbon steel (EN-1.1191)			
26, 28, 43	Screw	Carbon steel (EN-1.1191)			
27	Stud	Carbon steel (EN-1.1181)			
29	Screw	Stainless steel (EN-1.4401)			
30	Nut	Carbon steel (EN-1.1141)			
31	Washer	Stainless steel (EN-1.4401)			
32	Nut	Stainless steel (EN-1.4401)			
33, 44	Washer	Carbon steel (EN-1.1141)			
34	Disc spring	Vanadium chrome steel (EN-1.8159)			
35, 36, 37	Joint	Copper			
38, 39	Seal	Graphite			
40	Coupling	Carbon steel (EN-1.1191)			
41	Spring	Stainless steel (EN-1.4310)			
42	Elastic gudgeon	Carbon steel (EN-1.1231)			
45	Servomotor	—			
46	Flanges	Carbon steel (EN-1.0460)			
DN		15 to 25 (EN,ANSI)			
PN		40			
OPERATING CONDITIONS	PRESSURE IN bar	40	35	32	28
	MAXIMUM TEMPERATURE IN °C	120	200	250	300

### Operation

If the accepted conductivity value previously selected is exceeded the desalting controller RD-1, via indication from the conductivity electrode EC-1, operates the servomotor and opens the continuous desalting valve to the **OPEN** position. When the conductivity decreases the adjustment mechanism returns to the **SERVICE** position giving continuous economical desalting. When the "valve closed" switch is on the adjustment mechanism automatically puts the valve in the **CLOSED** position. These positions are fixed by the micro limit switches.

### Adjustment of micro limit switches

The micro limit switches come ready adjusted from the factory:

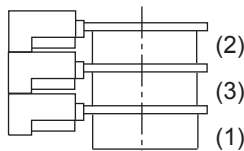

Micro switch position	Position of the lever on the indicator plate
(1) CLOSED	0
(2) SERVICE	8
(3) OPEN	35

Using a screwdriver the positions of the micro switch can be readjusted. Turning the right to left decreases the purge position and turning it the left to right increases it.

### Manual or automatic operation

To operate the valve manually:

- 1- Cut off the power supply.
- 2- Mark the position of the regulation lever on the indicator plate.
- 3- Push the connection against the spring and turn it 90°.
- 4- Place the regulation lever in the required position.

Restoring automatic operation:

- 1- Place the regulation lever in the position marked on the indicator plate.
- 2- Turn the connection 90° and fit it in the axis of the measuring nozzle.
- 3- Reconnect the power supply.

### **B** Servomotor

Reversible synchronised motor.  
Gearbox with permanent lubrication.  
Voltage: 220 V.A.C. ± 10% 50/60 Hz.  
Commutated micro limit switches: 3.  
Adjustment time: 135 s/90°.  
Cell: Maximum load. 15 Nm.  
Ambient temperature: 50°C.  
Protection: IP-54.

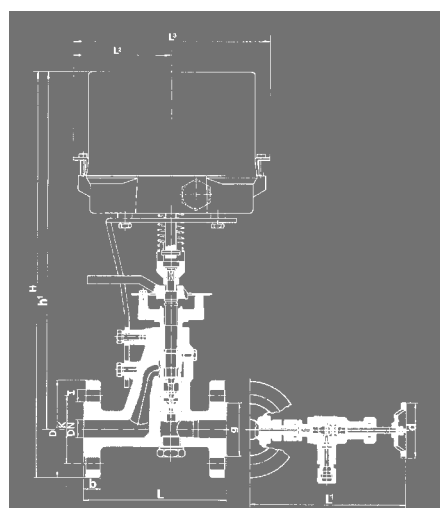

CONNECTIONS	DN 15			DN 20			DN 25		
	I- Flanges PN-40 EN-1092-1								
	II- Flanges class 150 lbs ASME/ANSI B 16.5								
	III- Flanges class 300 lbs ASME/ANSI B 16.5								
	I	II	III	I	II	III	I	II	III
H	376	373	376	381	378	386	386	383	391
h1	328			328			328		
L	150			150			160		
L1	167			167			167		
L2	65			65			65		
L3	130			130			130		
d	60			60			60		
D	95	90	95	105	100	115	115	110	125
K	65,00	60,30	66,70	75,00	69,90	82,60	85,00	79,40	88,90
l	14,00	15,90	15,90	14,00	15,90	19,10	14,00	15,90	19,10
b	16,00	11,20	14,30	18,00	12,70	15,90	18,00	14,30	17,50
DRILLS N°.	4			4			4		
WEIGHT IN Kgs.	7,20	6,45	6,91	7,60	6,85	7,67	8,16	7,48	8,45
CODE 2102-560.	80241	802410	802413	83441	834410	834413	81041	810410	810413

# Conductivity electrode. EC-1



Connection: Whitworth gas-tight cylindrical male thread ISO 228/1 1978 (DIN-259) 1".  
NPT thread ANSI-B2.1 via adapter. 1" F-GAS to 1" or 1 1/4" M-NPT.

Maximum operating temperature: 238°C.

Maximum operating pressure: 32 bar.

Protection: IP-65.

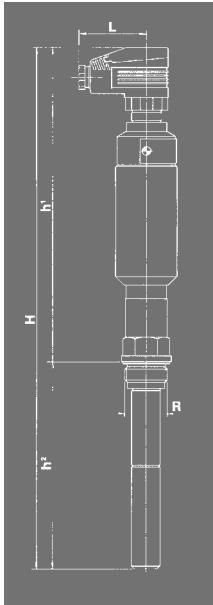

R	1"
H	419
h <sup>1</sup>	252
h <sup>2</sup>	167
L	53
WEIGHT IN Kgs.	0,97
CODE	2102-560.7102

## Electrode connection collector

Nominal pressure: PN-40.

Allowable pressures and temperatures according to DIN-2401. Sheet 2.

Flange connection: DN-20 (EN-1092-1).

Electrode connection: Whitworth gas-tight cylindrical female thread ISO 228/1 1978 (DIN-259) 1".

DN	20
R	1"
H	390
h <sup>1</sup>	267
h <sup>2</sup>	157
h <sup>3</sup>	110
L	115
R <sub>1</sub>	1/2"
L <sup>1</sup>	100
D	105
K	75
I	14
b	18
DRILLS N°.	4
WEIGHT IN Kgs.	3,33
CODE	2102-560.83442

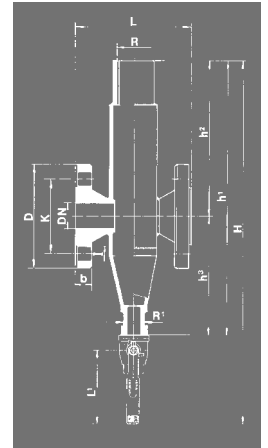

We recommend adding a blowoff valve to the equipment, Mod. 999, 1/2" joined to the waste pipe for periodic release of sludge. As a minimum a 2 ÷ 3 second release must be performed every 8 hours.

# Desalting controller. ARD-1. RD-1

Voltage: 220 V.A.C. ± 10% 50/60 Hz.

Electric consumption: Approximately 4,5 VA.

Relay contact: 250 V/4 A 750 VA.

Safety contact: Maximum 2A-Mitteltraeg.

Ambient temperature: -20 to + 70°C.

Regulator protection: IP - 00.

Regulator protection in assembly cupboard: IP - 50.

Regulation index: 2,5 to 20 mS.

Limit index: 40 to 75 mS.

Desalting controller with assembly cupboard ARD-1.

Desalting controller without assembly cupboard RD-1.

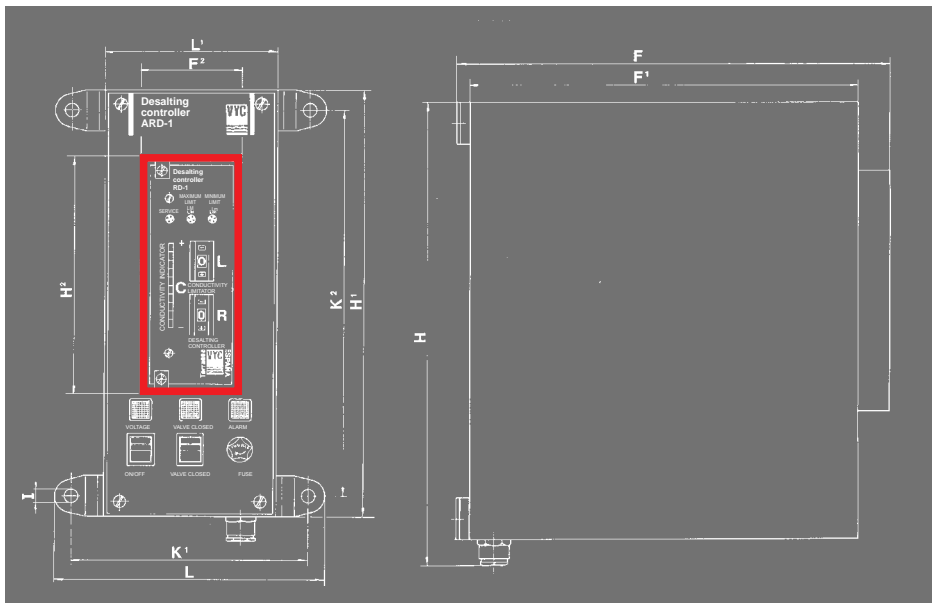

MODEL	ARD-1	RD-1
H	265	—
H <sup>1</sup>	250	—
H <sup>2</sup>	—	137
F	245	—
F <sup>1</sup>	220	—
F <sup>2</sup>	—	57
L	158	—
L <sup>1</sup>	100	—
K <sup>1</sup>	138	—
K <sup>2</sup>	226	—
I	7,5	—
WEIGHT IN Kgs.	2,50	0,93
CODE 2102-560.	0001	0002

The desalting controller without assembly cupboard RD-1 is supplied in a 19" sub-rack according to DIN-41494.

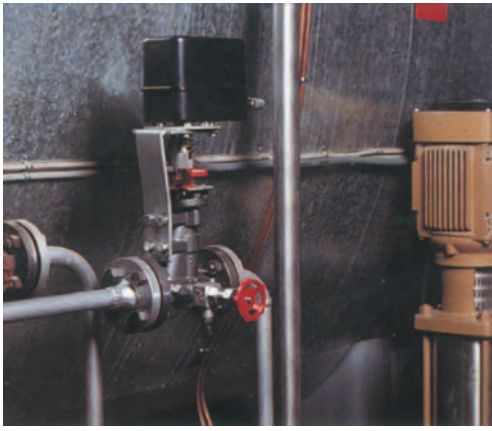

### Installation examples

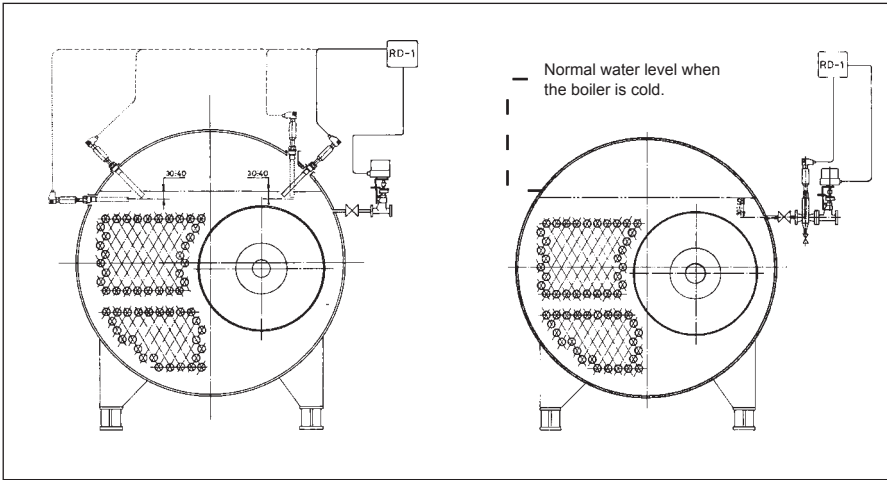

### Operation, efficiency and emptying

To establish the boiler's salinity, the quantity of salts extracted per unit of time must be equal to that of the water supply in this same period. This can be expressed in the following way:

$$M \cdot A = S \cdot P$$

- Q = Real steam production of the boiler. (Kg/h).
- A = Water supply. (l/h).
- M = Salinity of the water supply. (mg/l).
- P = Water extracted in the bleeding process. (l/h).
- S = Desired salinity inside the boiler. (mg/l).
- ρ = Specific mass of water inside the boiler. (Kg/l).
- p = Working pressure. (bar).

Example:  
 Q = 1.000 Kg/h.  
 M = 1.000 mg/l.  
 S = 6.000 mg/l.  
 ρ = 1 Kg/l.  
 p = 13 bar.

The effect is achieved when the salts are removed continuously and without movement to prevent uncontrolled water losses from the boiler.

The water to be bled in relation to the steam produced is:

$$P = \frac{M}{(S-M) \cdot \rho} \cdot Q$$

P = 200 l/h.

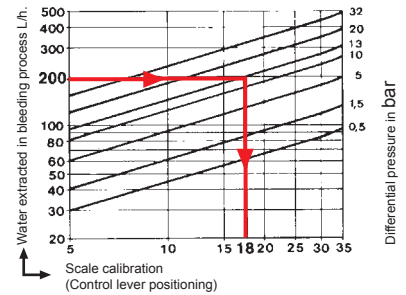

Using the calibrated scale, the lever allows exact adjustment of the measuring nozzle.

We shall set the lever at the position that allows us to remove a volume of water (P) at a differential pressure. Differential pressure = Working pressure - (Back pressure + Load losses). Continuous desalting is achieved with adjustment values of 0 to 35.

The position "Direct bleeding" corresponds to the section of nozzle that is totally open and allows complete bleeding in a few seconds. In this case, the volume is approximately three times greater than that for 35 on the scale.

The combination of the Continuous desalting valve\* and the Blowdown valve for bleeding dirt and sludge\* is essential for optimizing the boiler's efficiency, and include its maximum security and availability. Neither of them can be replaced with others not designed for this specific application. Their moderate cost is depreciated in the short term.

\* (See brochure for Models 560).  
 \* (See brochure for Models 260, 260-A and 460).