

## Level electrode EN-1

### 1. Description of the electrode.

The level electrode is a measuring probe, which must be handled with extreme caution. Avoid bumping, especially in the area of the rod (6).

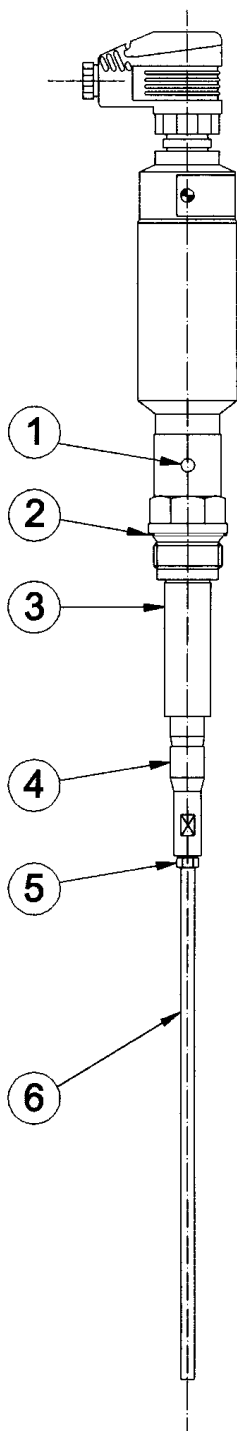

- (1) Inspection holes.
- (2) Coupling.
- (3) Insulation cover.
- (4) Junction.
- (5) Nut.
- (6) Rod.

### 2. Mounting the rod.

Insert the rod (6) into the junction (4), screwing it approximately 10 mm. in, and make fast with the nut (5).

Do not hold the electrode fast with a screw or fixed spanner. Place it on a level surface and hold the junction (4) fast with a fixed spanner, turning the nut (5) with a ring spanner.

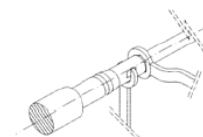
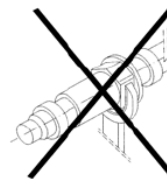
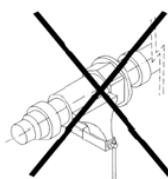

### 3. Checking the axial alignment.

Roll the electrode on a level surface and measure the highest and lowest positions of the end of the rod (6). The difference should not exceed 12 mm. If it is greater, the electrode must be realigned.

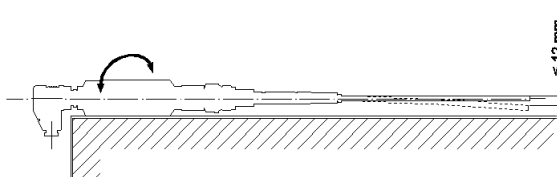

### 4. Installation of the electrode.

Before installing the electrode, clean the insulation cover (3) using a clean, slightly damp cloth. The insulators should be completely free of oil and grease. After putting the coupling (2) in place, screw in the electrode by hand and fasten with spanner.

**WARNING:** ! Use only stainless steel couplings (2) !

! The coupling must be replaced each time the electrode is mounted !

When the electrode is screwed into a screwed-on flange, it is recommendable to hold the flange fast with a screw. If several electrodes are housed in a single flange, the distance between the rods (6) should be no less than 12 mm. at any point.

If the flange is inserted into a tube or collector, it should be possible to tilt the flange in all directions by at least 8 mm., without the rod (6) touching the tube or collector. Once this has been ensured, the flange is screwed tight.

In order that the commutation be adequate, and depending on the conductivity of the water, the electrode should be submerged about 15 mm. beneath the normal level of hot water to be regulated. The exact point of commutation may only be determined if the boiler is in proper working condition. For this reason, we recommend that the rod (6) be cut from time to time, until the required commutation point is found. We recommend the use of 2 x 1 screened connection cable with a maximum length of 50 mts.

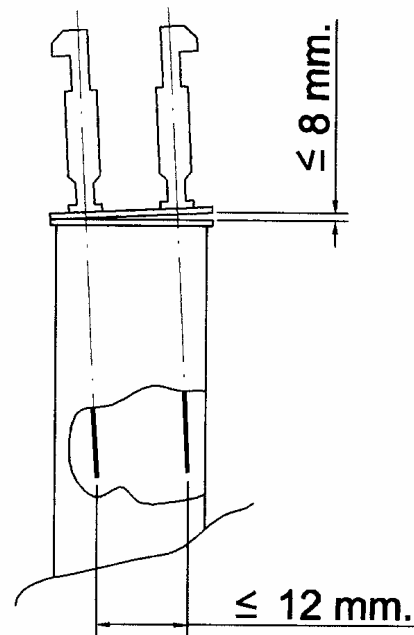

## 5. Connecting the electrode.

Unscrew the connector cover lock screw (7), remove the connector cover (8) and connector body (9), and unplug the contact holder (10). Pass the cable through the stuffing box (11), fixing one wire to connection N° 1 and the other to the earth connection of the contact holder (10). Check the connections and place the contact holder (10) into the plug (12) with its corresponding coupling (13). Put the connector body (9) and connector cover (8) in place, and fasten the connector cover lock screw (7)

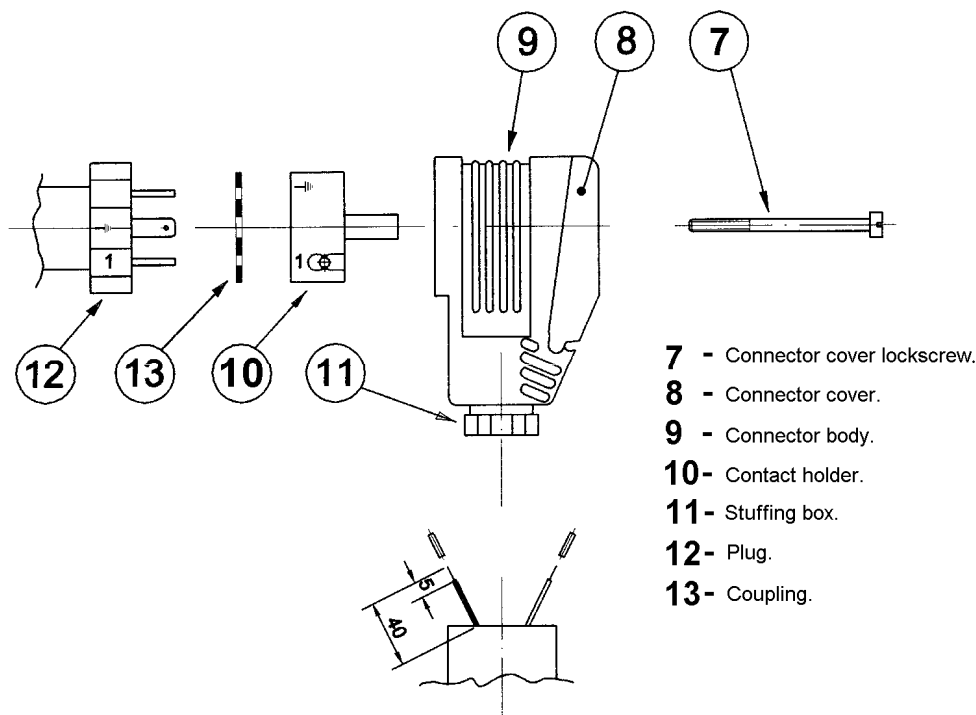

- 7 - Connector cover lock screw.
- 8 - Connector cover.
- 9 - Connector body.
- 10 - Contact holder.
- 11 - Stuffing box.
- 12 - Plug.
- 13 - Coupling.

### WARNING

! Make sure the coupling (13) is correctly positioned !  
! You may point the connector body (9) in any direction !.

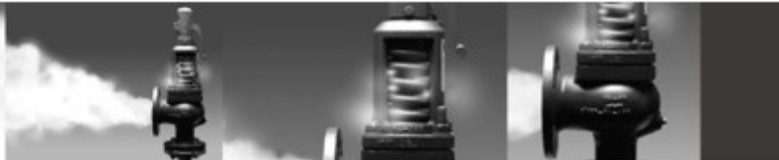

## 6. Start-up.

Check each electrode after all operations. Only if the findings are satisfactory may the electrodes be installed in the boiler and the boiler turned on.

## 7. Maintenance.

We recommend that the rod (6) of the electrode be checked every 6 months and that the electrode be thoroughly cleaned.

## 8. Anomalies.

Any leaks at the coupling (2) are usually solved by tightening it. If the leak does not disappear, replace the coupling (2) with a new one.

When the boiler is cold, any water or steam leakages may be detected via the inspection holes (1). Heat the boiler to working pressure and the leakage should disappear. If not, disconnect the electrode as described in section 5 and connect a new electrode.

## OPERATING DIAGRAM RN-1

